

Lecture 10

Fair Rent Division

Reminder about starting recording

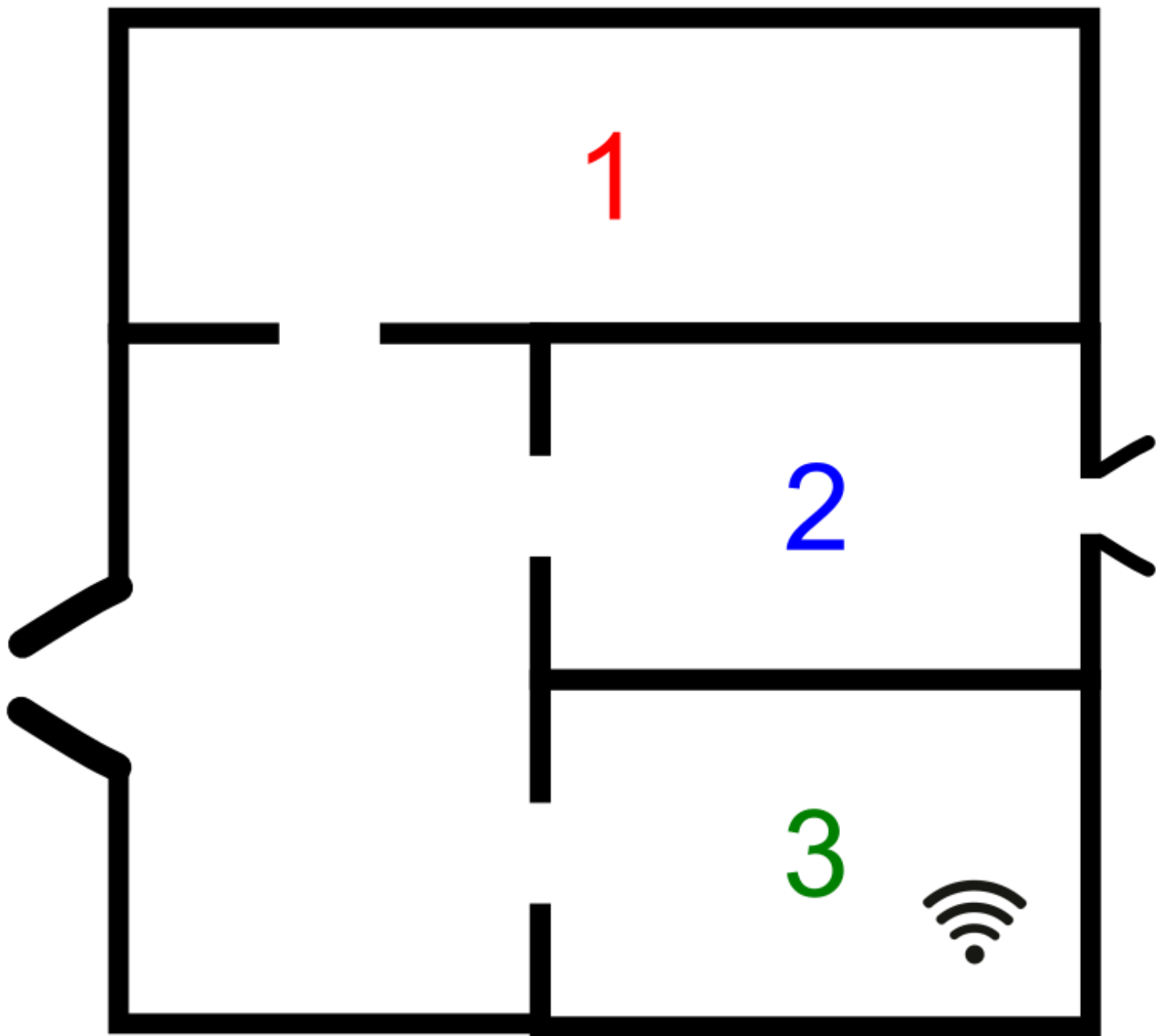



1

2

3



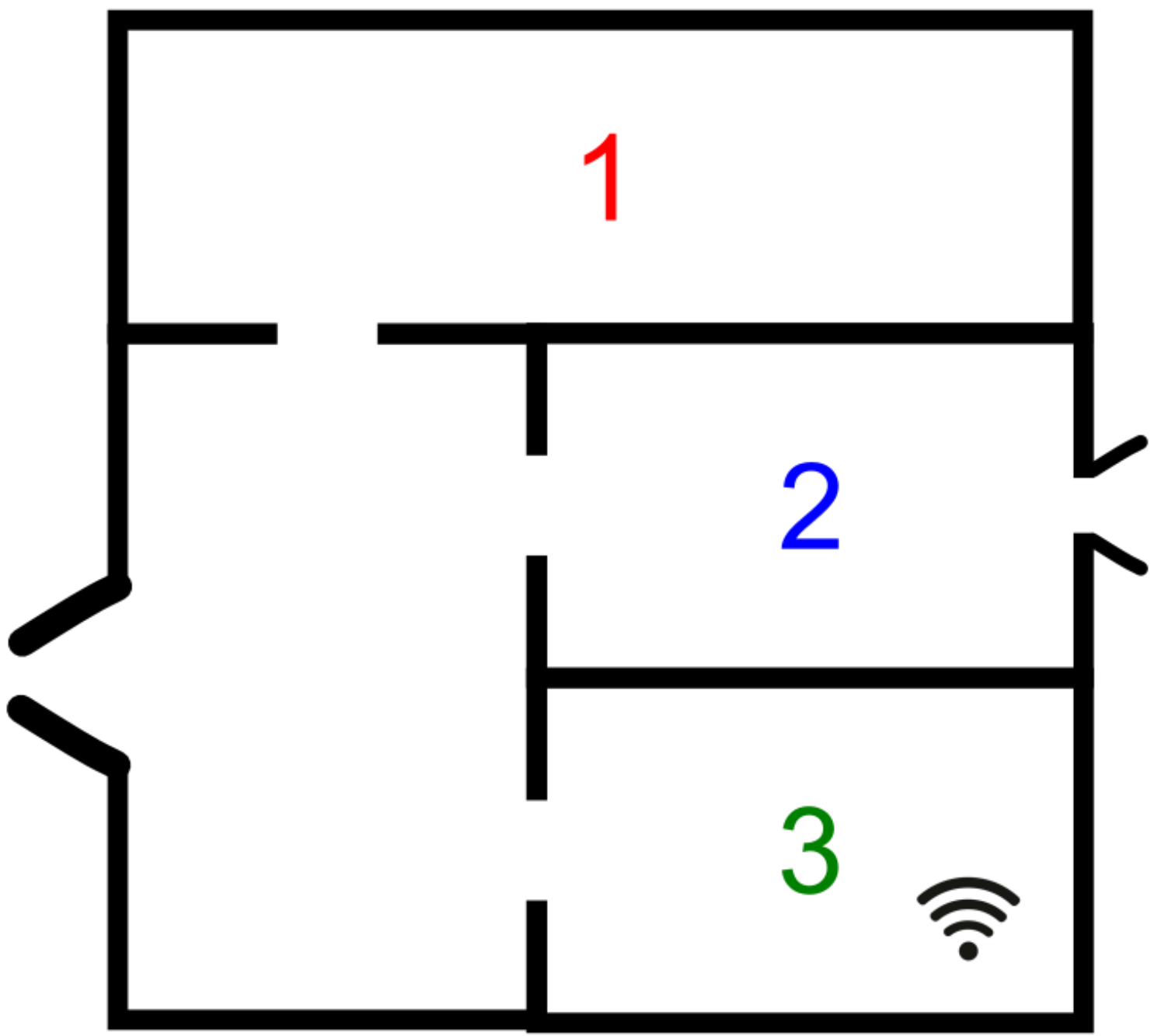

Rent
=
1000

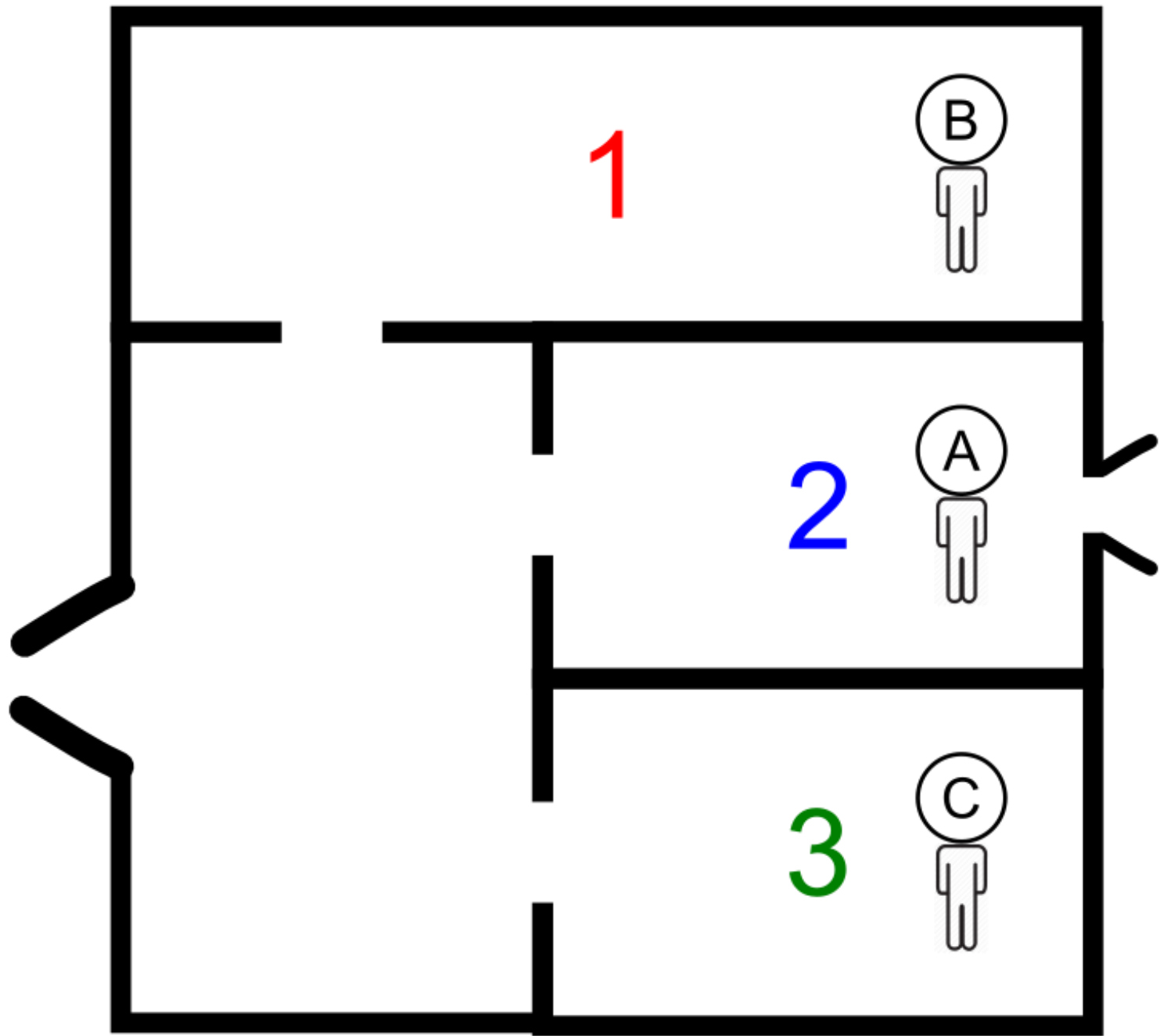

Rent
=
1000

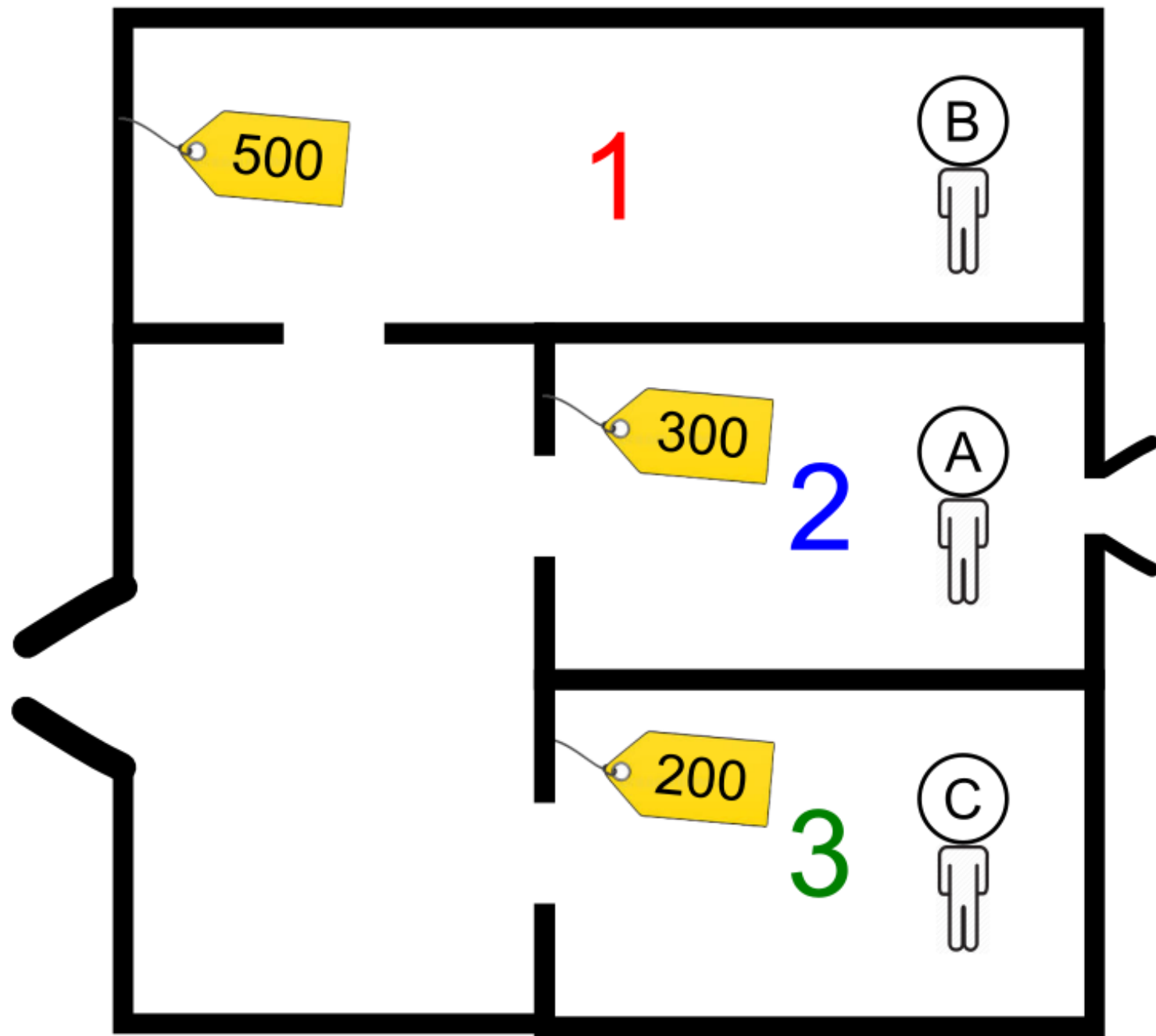

Rent
=
1000

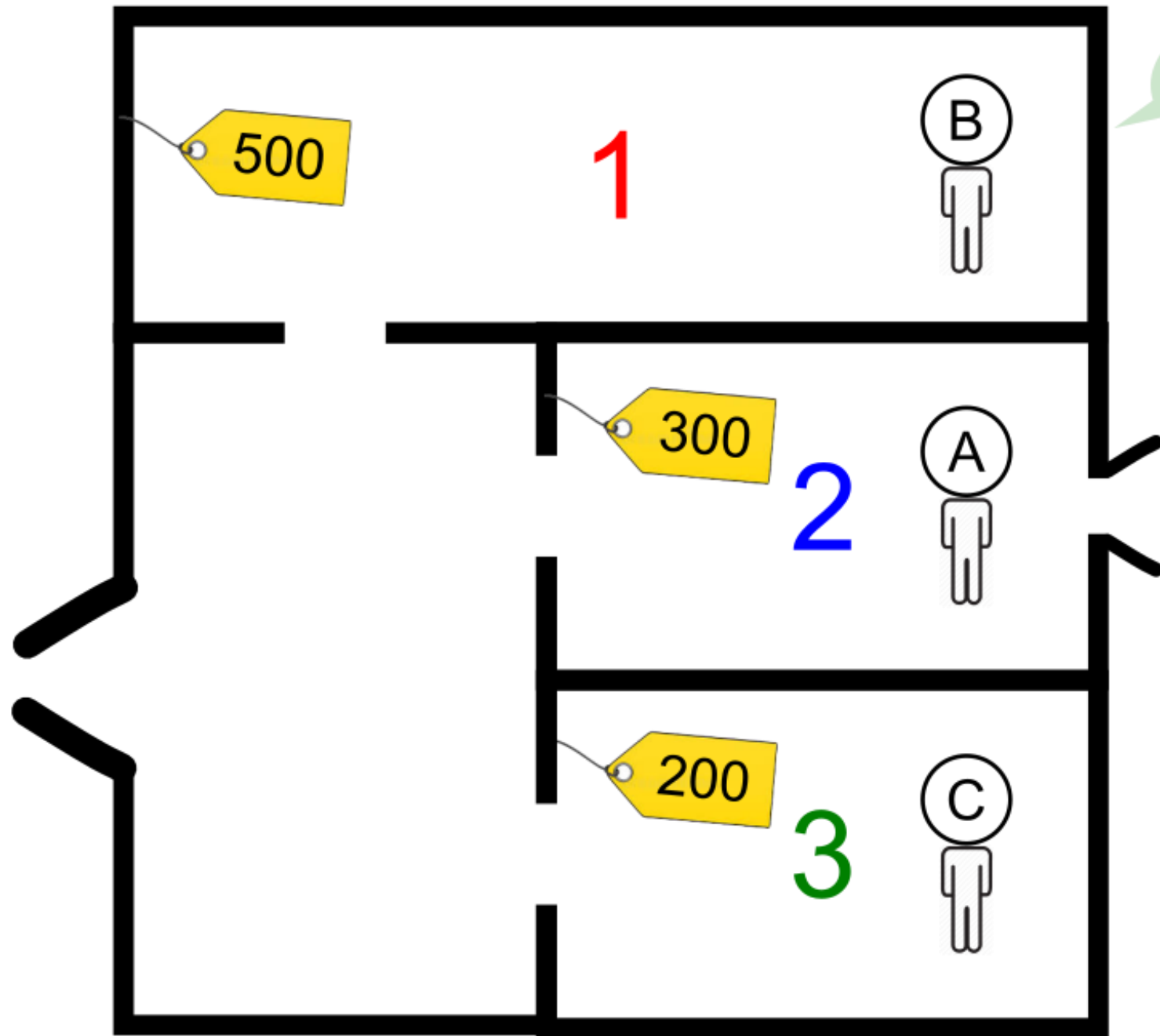

I like Room 1 for Rs. 500 over Room 2 for Rs. 300 and Room 3 for Rs. 200.

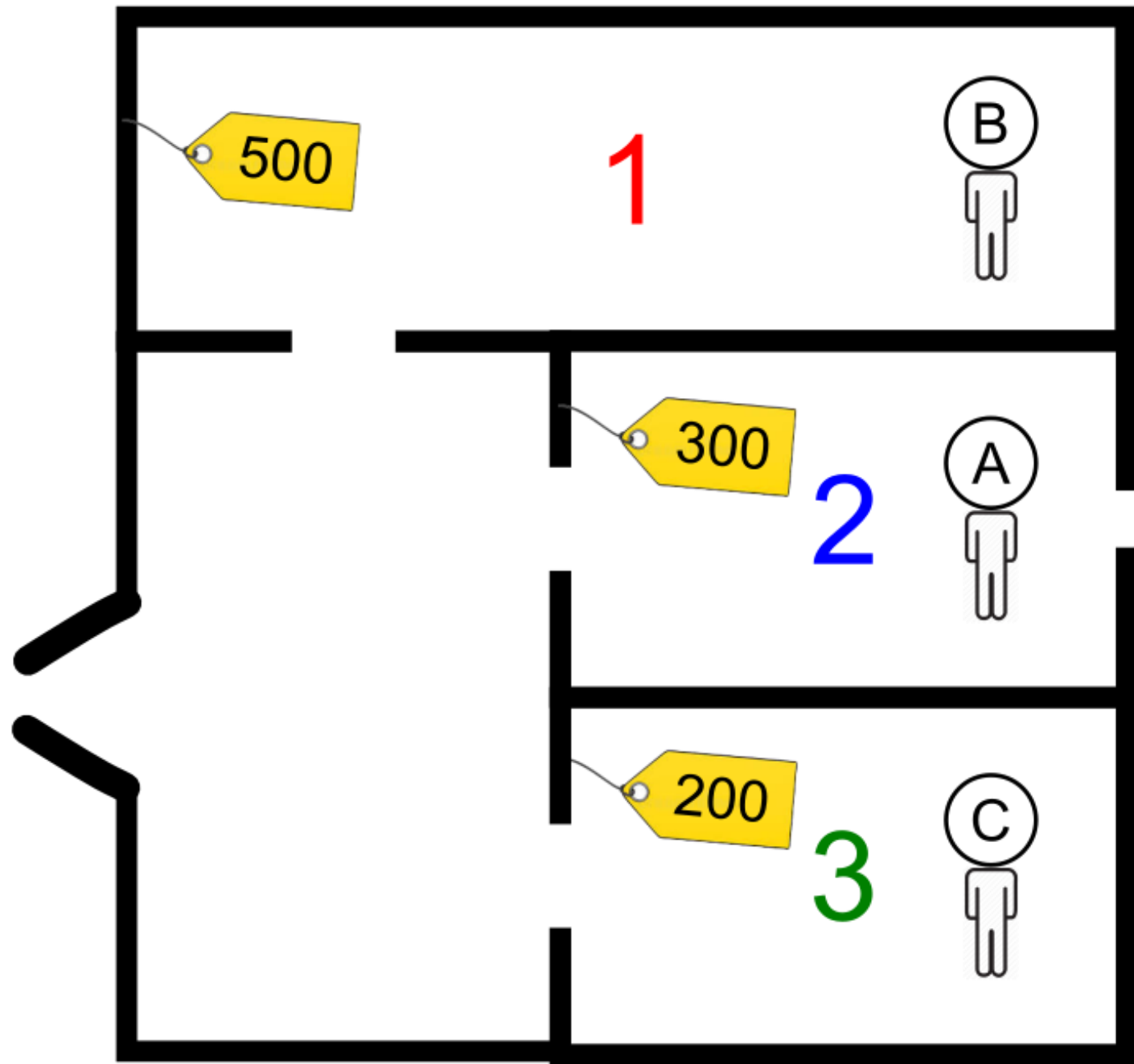

I like Room 1 for Rs. 500 over Room 2 for Rs. 300 and Room 3 for Rs. 200.

I like Room 2 for Rs. 300 over Room 1 for Rs. 500 and Room 3 for Rs. 200.

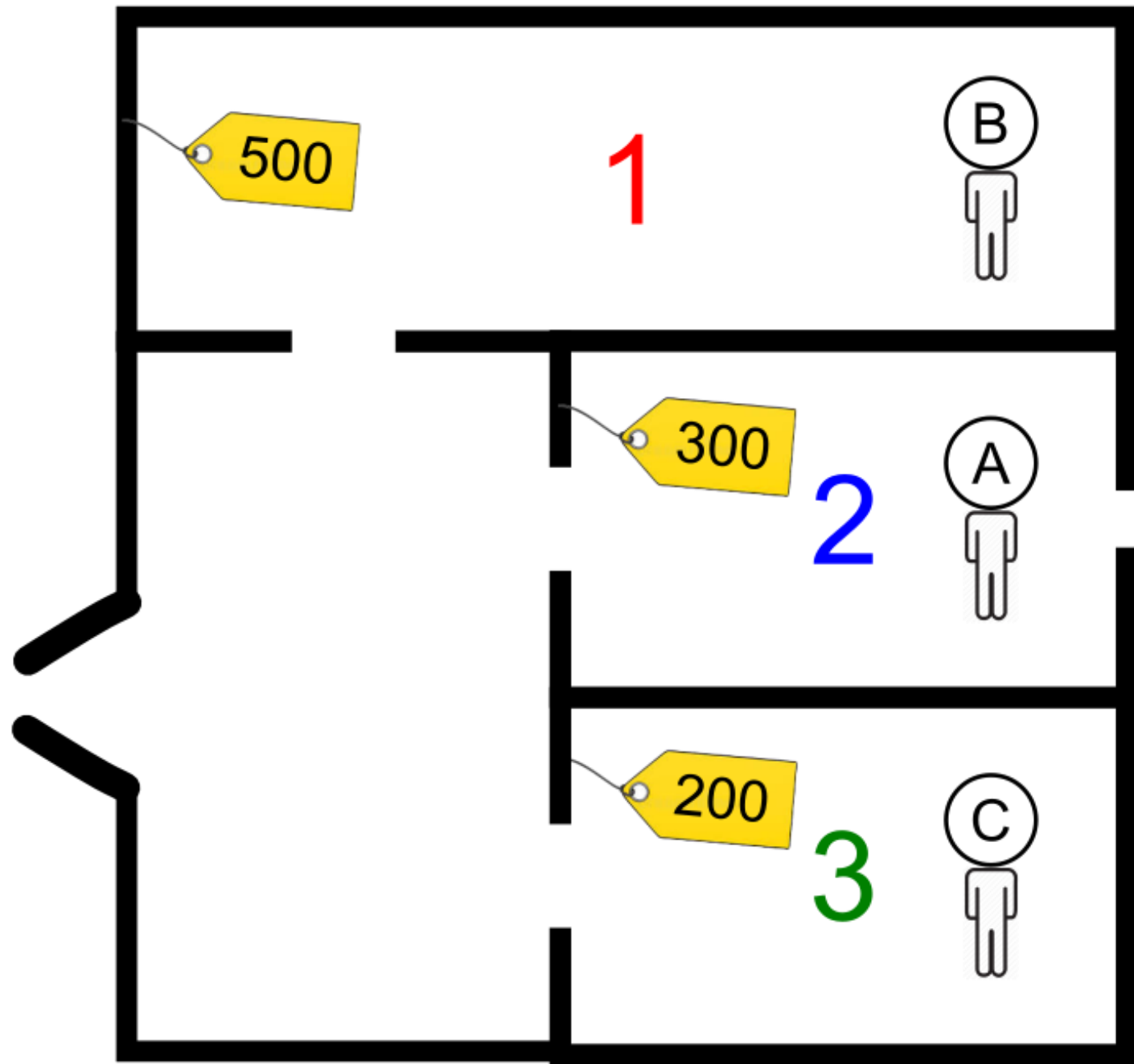

I like Room 1 for Rs. 500 over Room 2 for Rs. 300 and Room 3 for Rs. 200.

I like Room 2 for Rs. 300 over Room 1 for Rs. 500 and Room 3 for Rs. 200.

I like Room 3 for Rs. 200 over Room 1 for Rs. 500 and Room 2 for Rs. 200.

Envy-free rent division

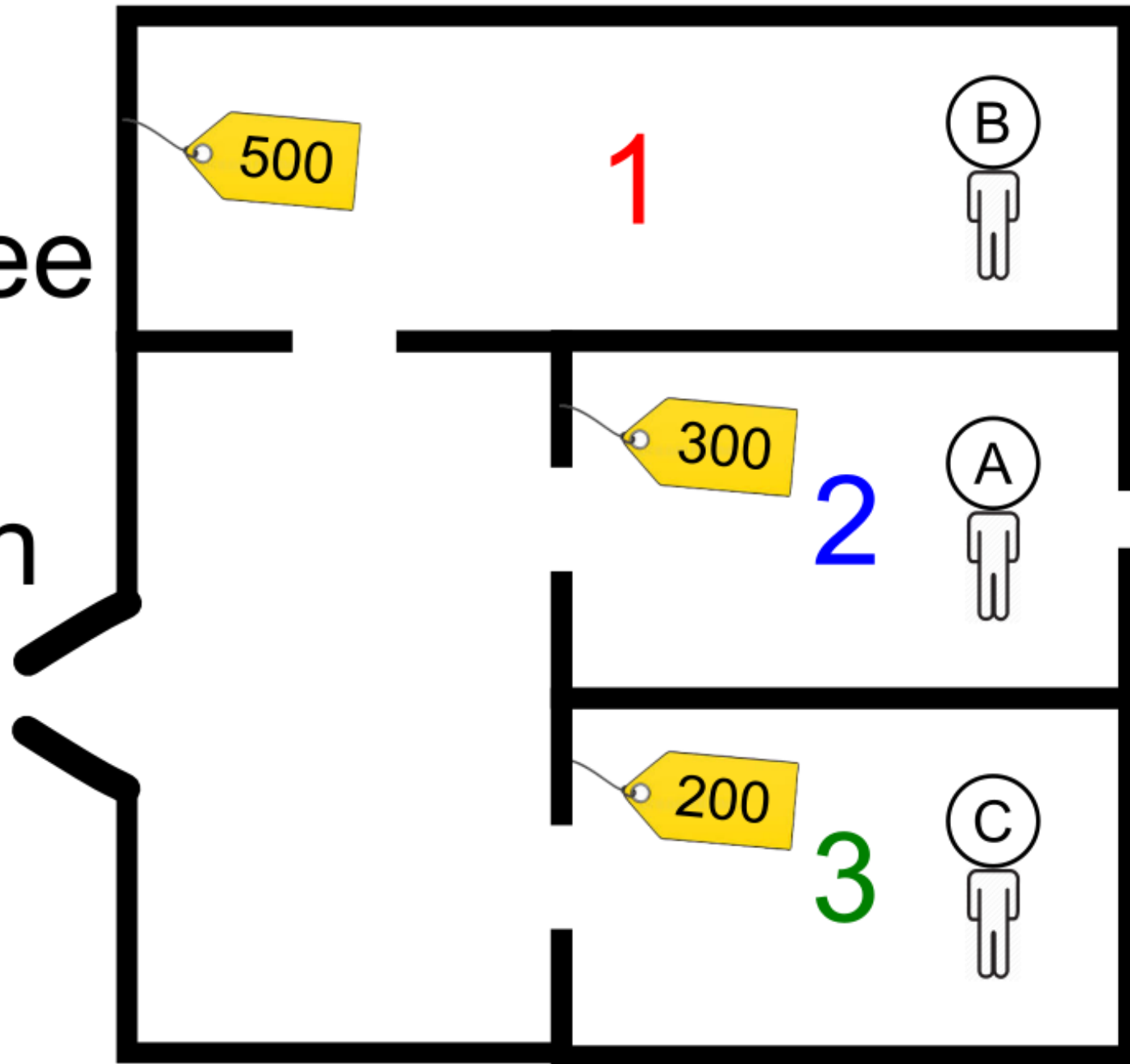

I like Room 1 for Rs. 500 over Room 2 for Rs. 300 and Room 3 for Rs. 200.

I like Room 2 for Rs. 300 over Room 1 for Rs. 500 and Room 3 for Rs. 200.

I like Room 3 for Rs. 200 over Room 1 for Rs. 500 and Room 2 for Rs. 200.

Sperner's Lemma

Sperner's Lemma

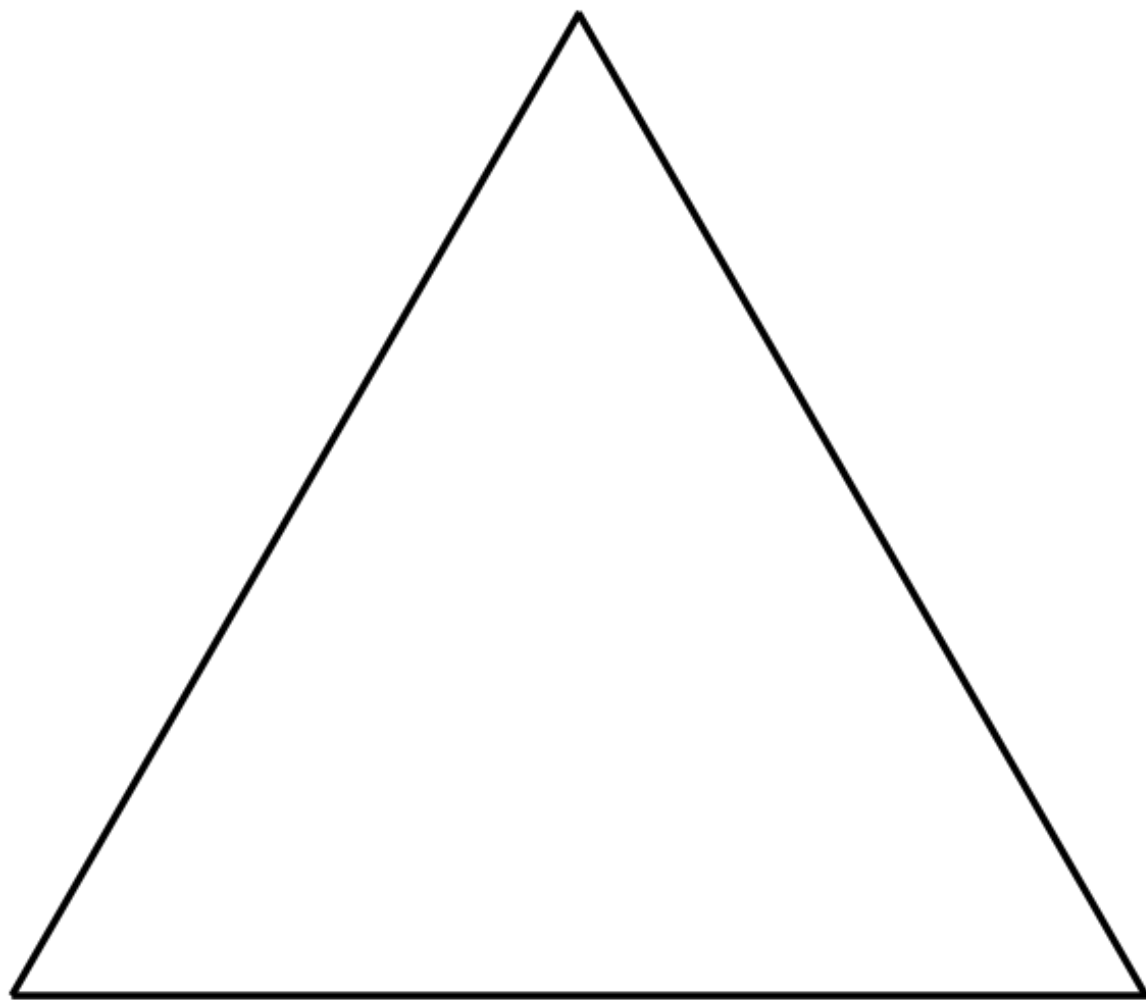

Sperner's Lemma

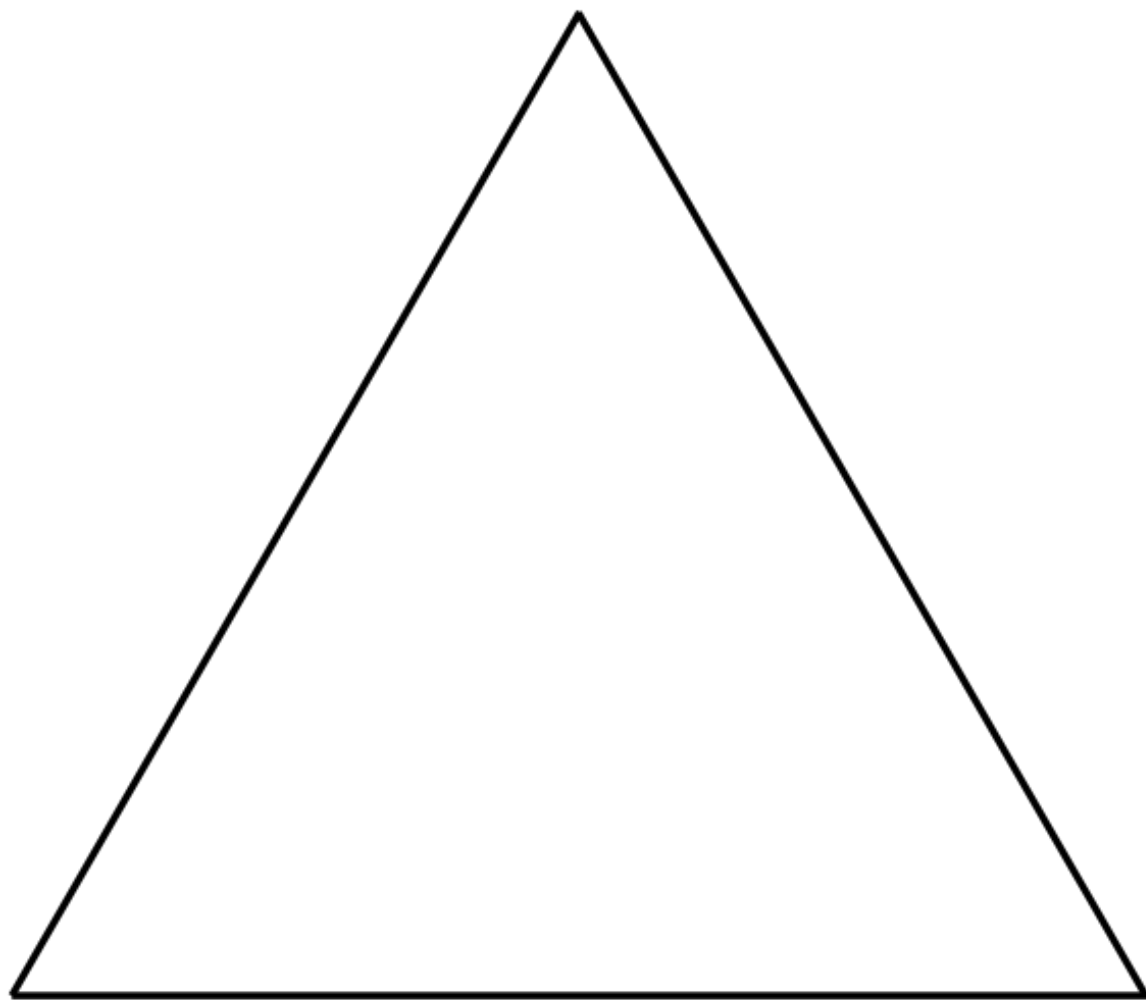

1. Triangulation into *elementary* triangles

Sperner's Lemma

1. Triangulation into *elementary* triangles

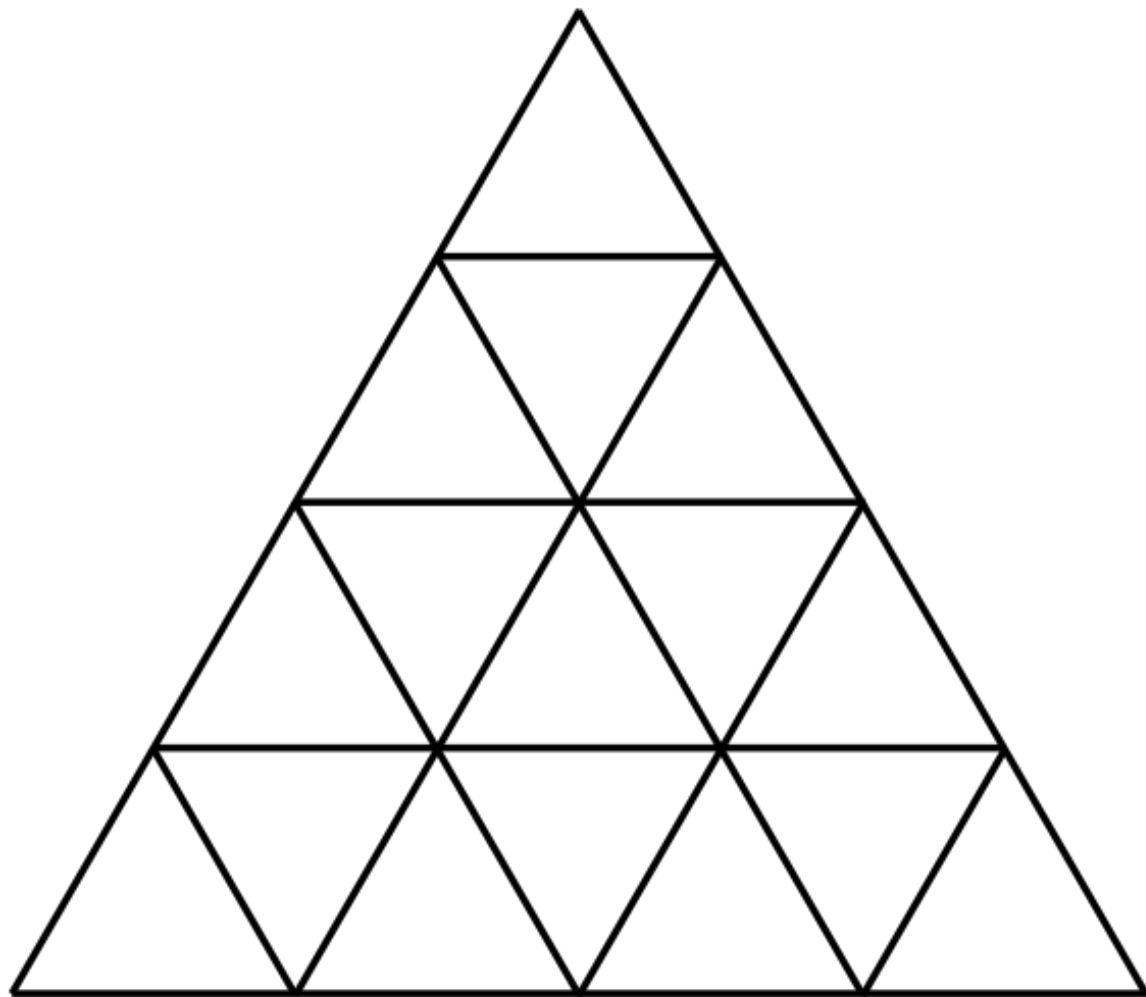

Sperner's Lemma

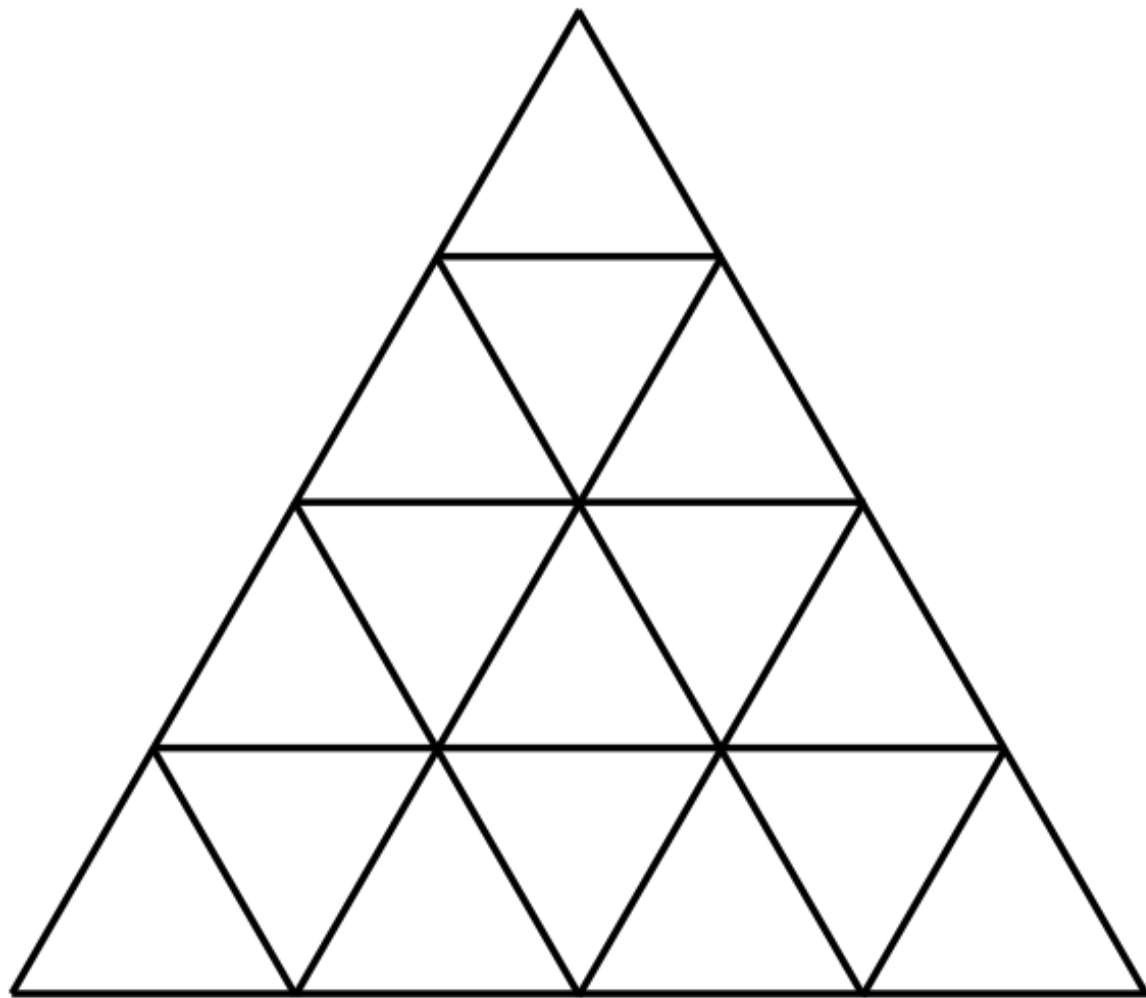

1. Triangulation into *elementary* triangles
2. Sperner labeling

Sperner's Lemma

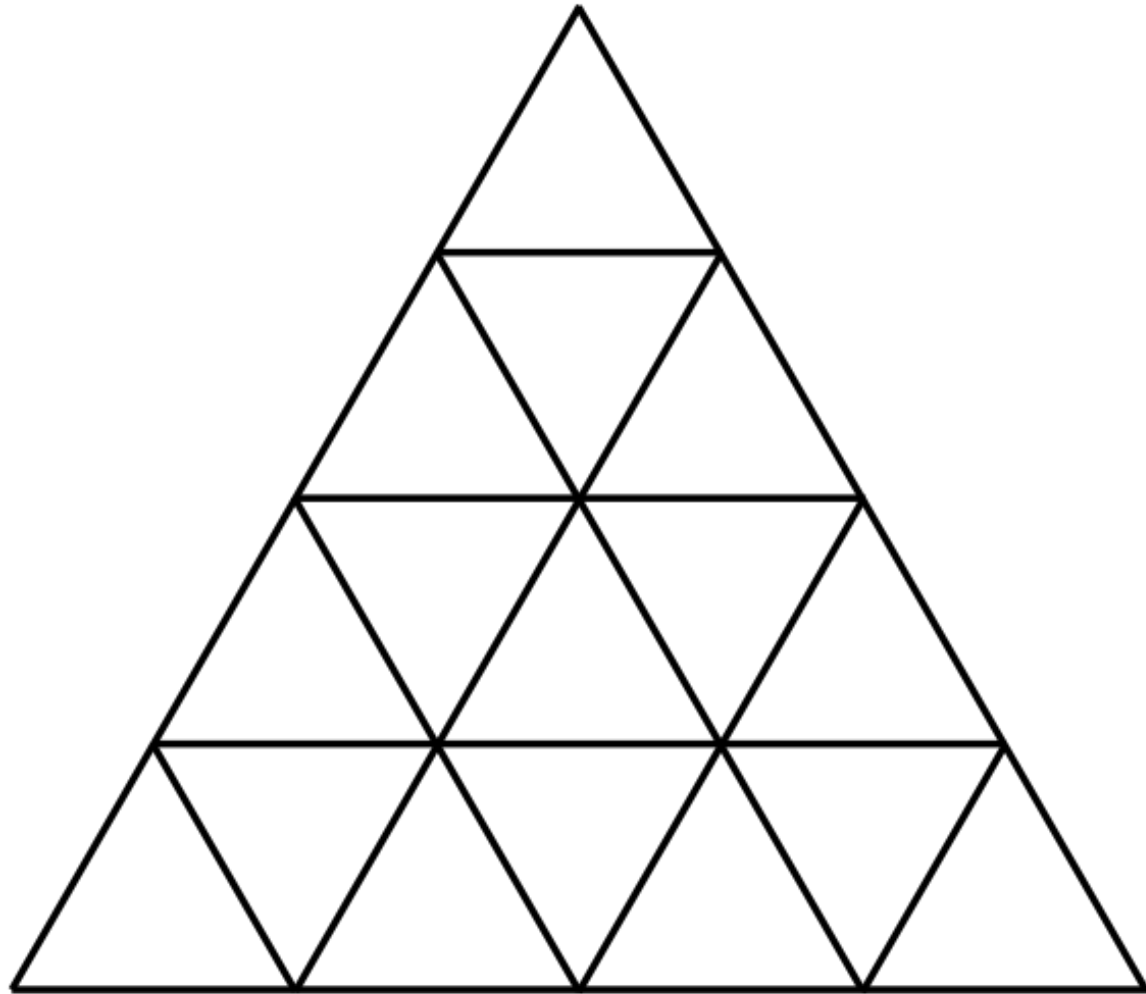

1. Triangulation into *elementary* triangles
2. Sperner labeling
 - Main vertices have distinct labels

Sperner's Lemma

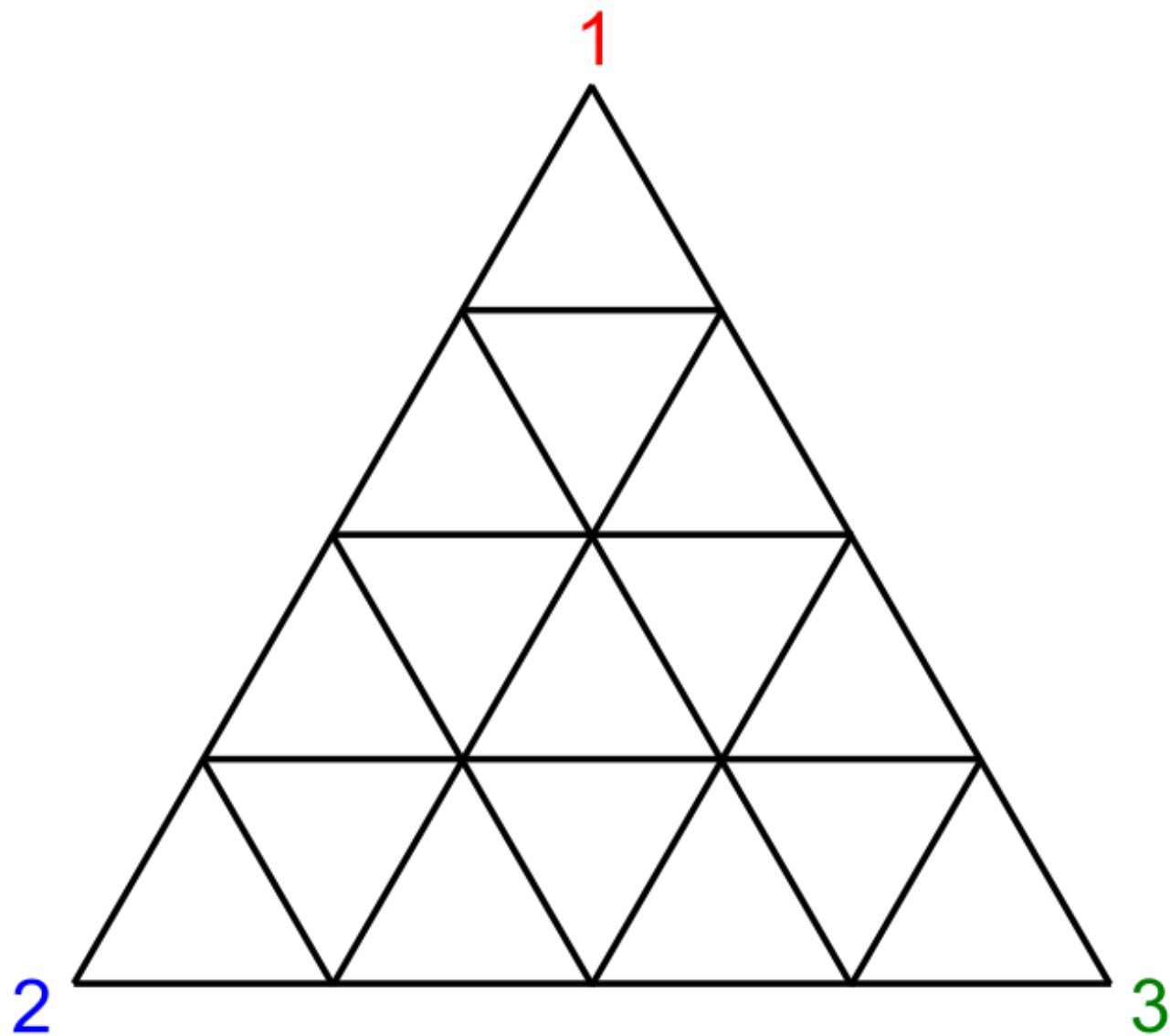

1. Triangulation into *elementary* triangles
2. Sperner labeling
 - Main vertices have distinct labels

Sperner's Lemma

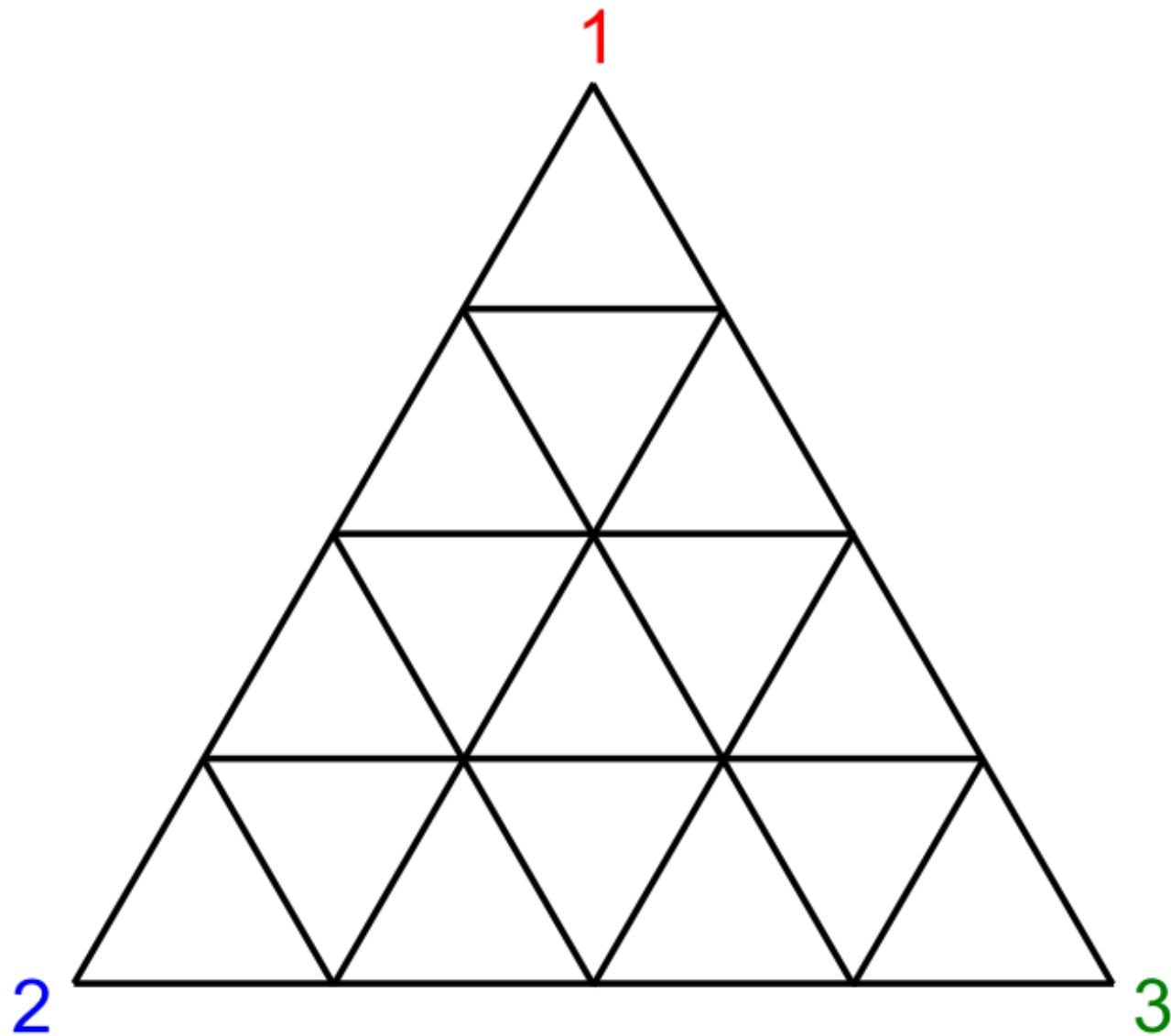

1. Triangulation into *elementary* triangles
2. Sperner labeling
 - Main vertices have distinct labels
 - Boundary vertices inherit the labels of the adjacent main vertices

Sperner's Lemma

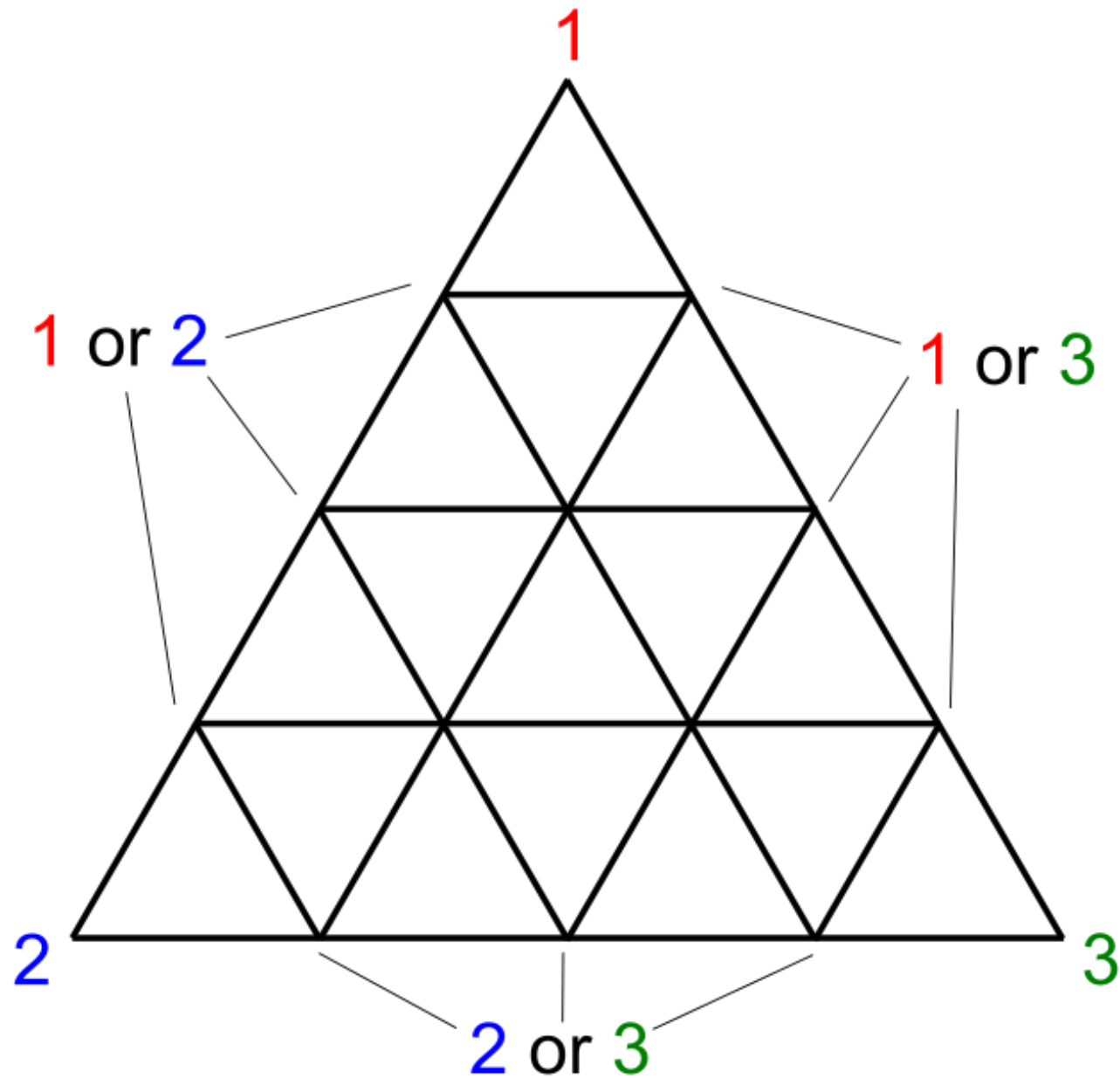

1. Triangulation into *elementary* triangles

2. Sperner labeling

- Main vertices have distinct labels
- Boundary vertices inherit the labels of the adjacent main vertices

Sperner's Lemma

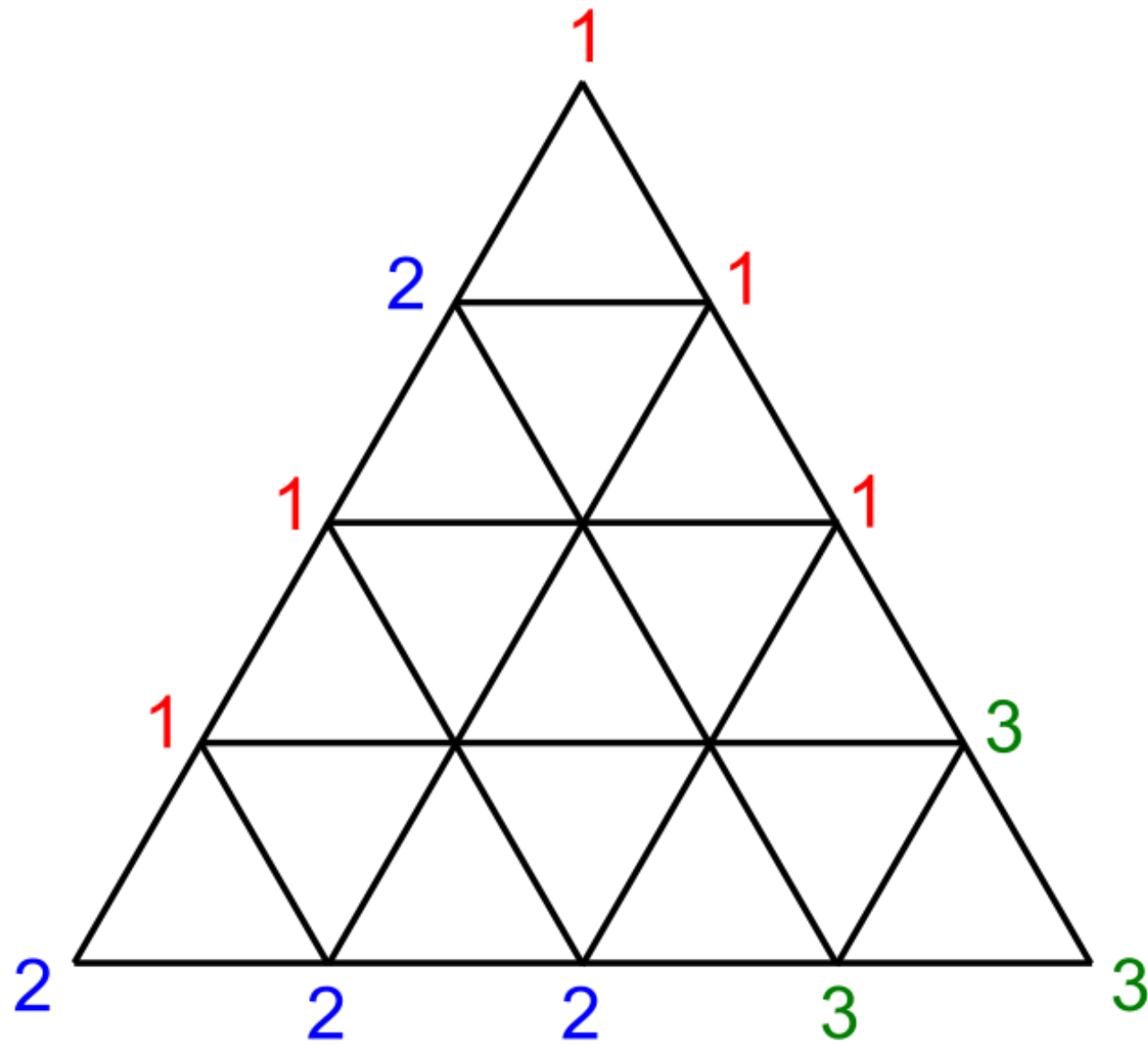

1. Triangulation into *elementary* triangles
2. Sperner labeling
 - Main vertices have distinct labels
 - Boundary vertices inherit the labels of the adjacent main vertices

Sperner's Lemma

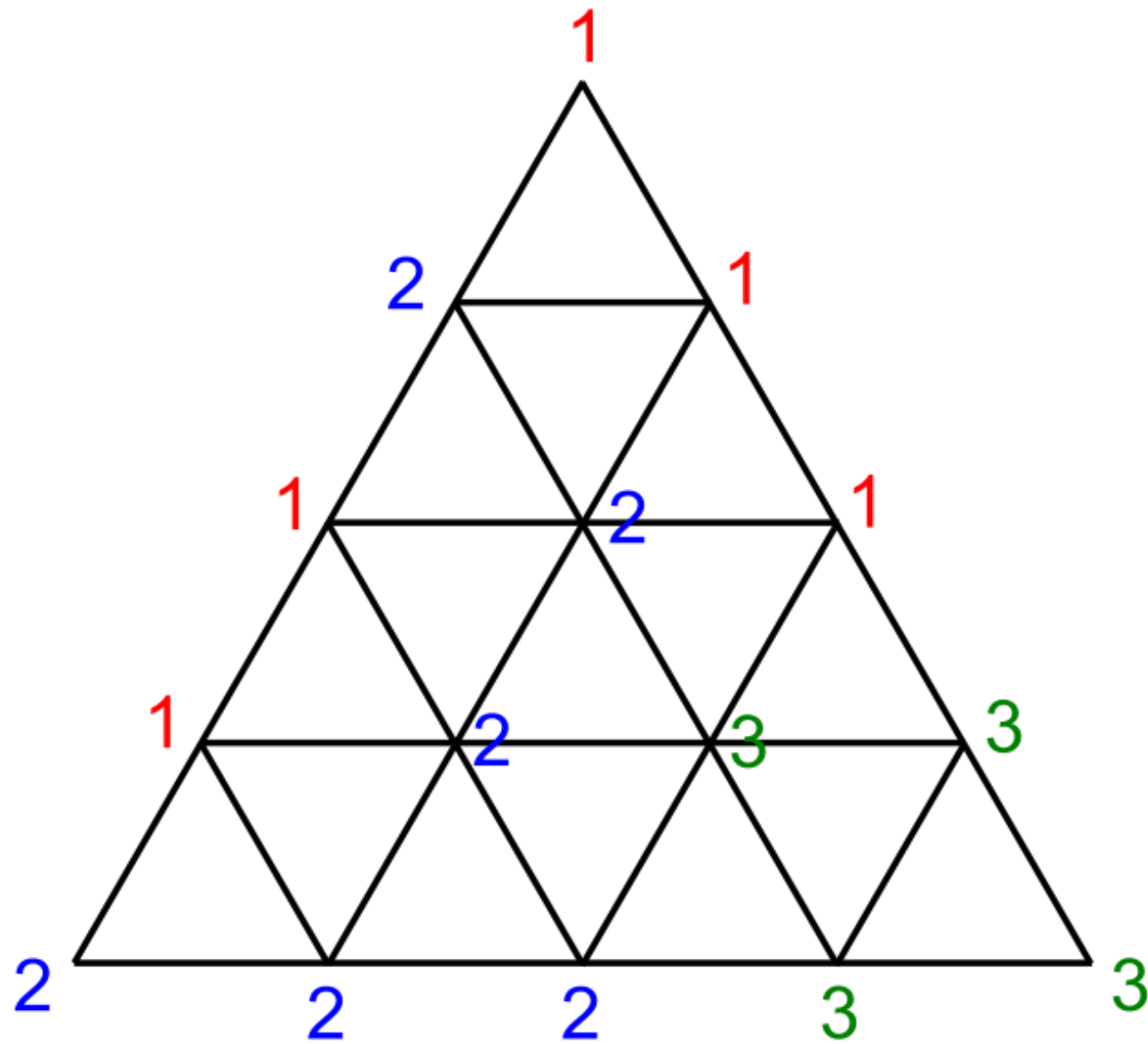

1. Triangulation into *elementary* triangles
2. Sperner labeling
 - Main vertices have distinct labels
 - Boundary vertices inherit the labels of the adjacent main vertices

Sperner's Lemma

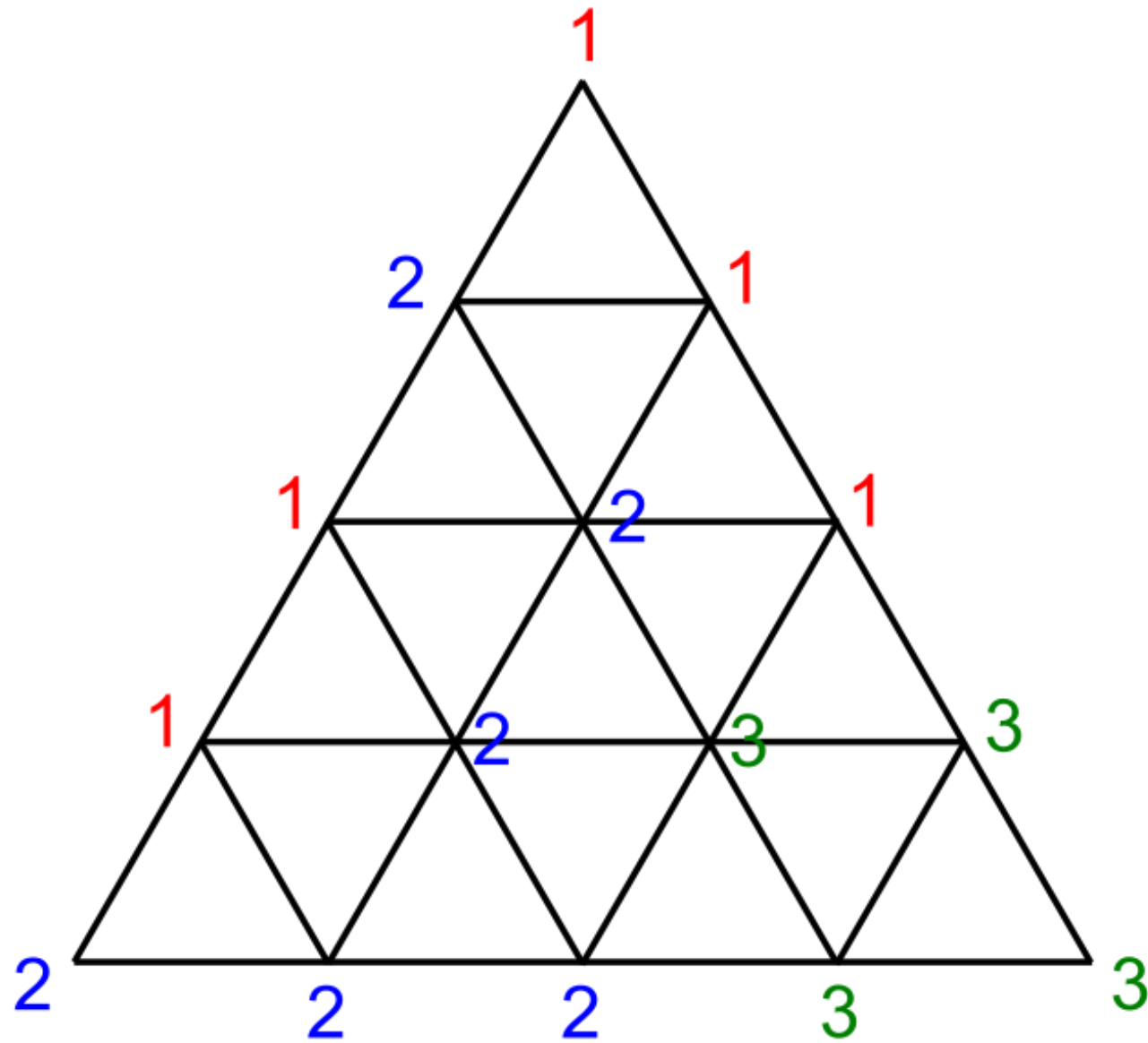

1. Triangulation into *elementary* triangles

2. Sperner labeling

- Main vertices have distinct labels
- Boundary vertices inherit the labels of the adjacent main vertices

[Sperner, 1928]

Any Sperner labeled triangulation has at least one fully labeled elementary triangle.

Sperner's Lemma

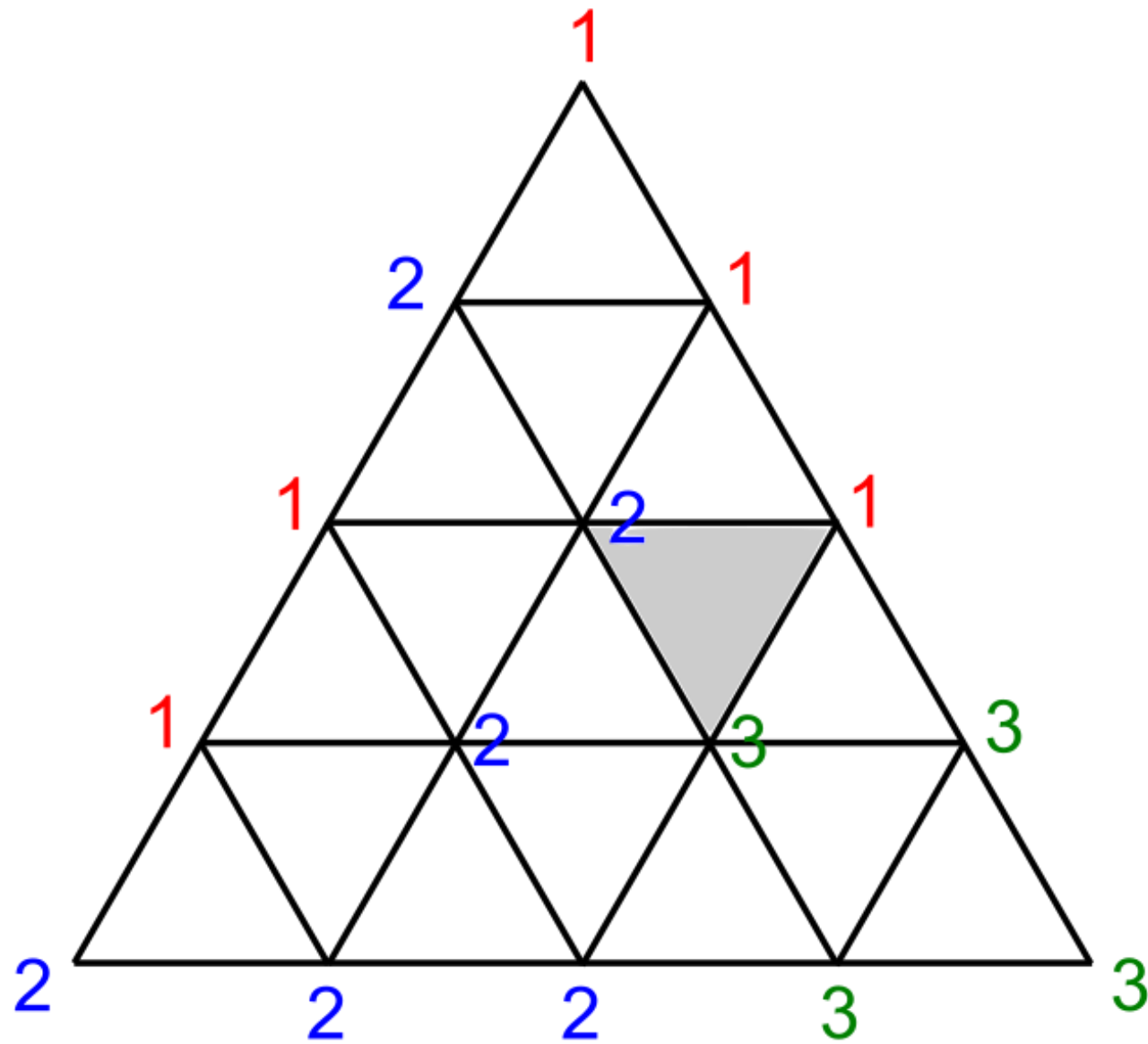

1. Triangulation into *elementary* triangles

2. Sperner labeling

- Main vertices have distinct labels
- Boundary vertices inherit the labels of the adjacent main vertices

[Sperner, 1928]

Any Sperner labeled triangulation has at least one fully labeled elementary triangle.

Proof Sketch of Sperner's Lemma

Proof Sketch of Sperner's Lemma

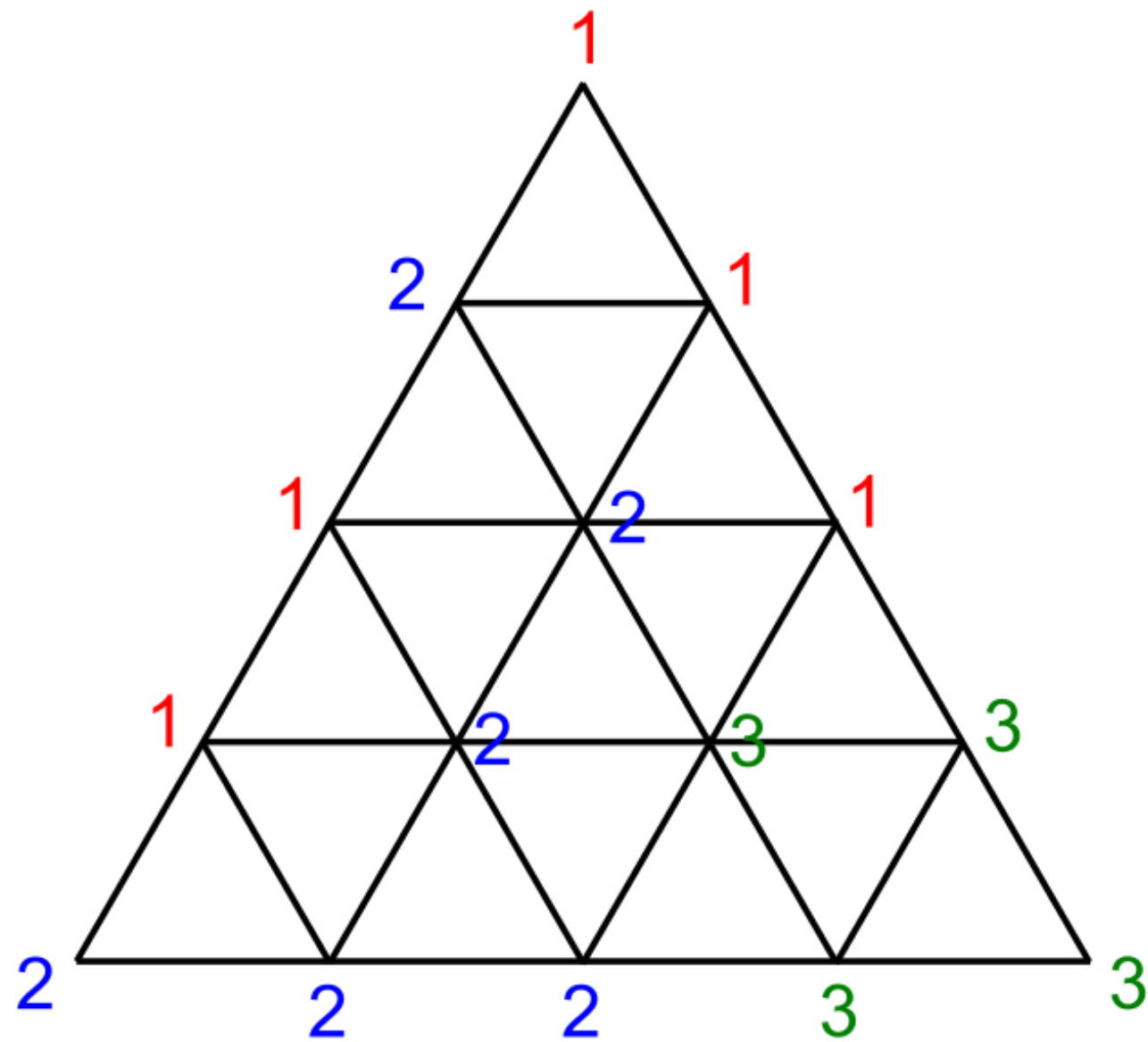

Proof Sketch of Sperner's Lemma

Call any 1—2 edge a "door".

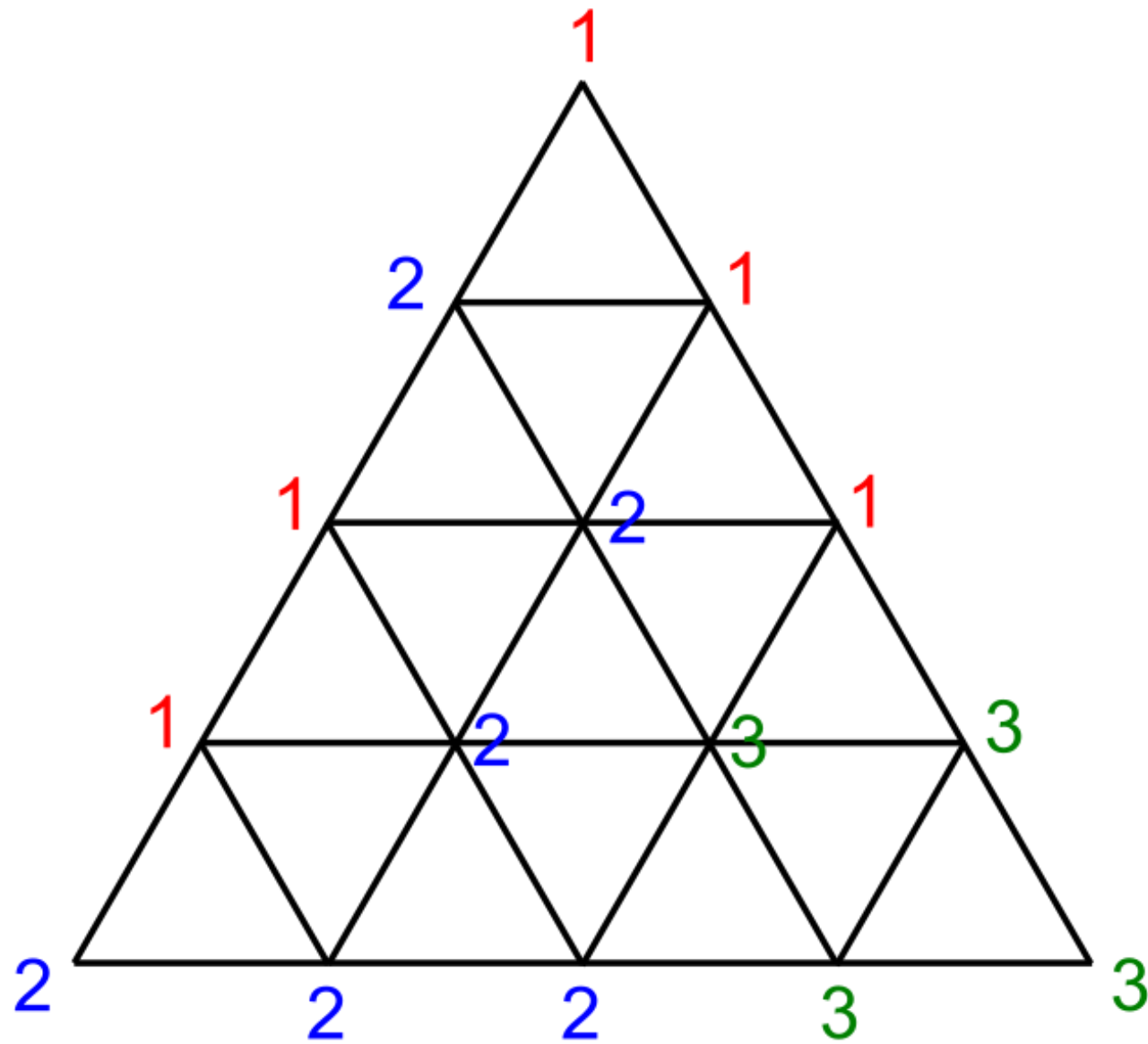

Proof Sketch of Sperner's Lemma

Call any 1—2 edge a "door".

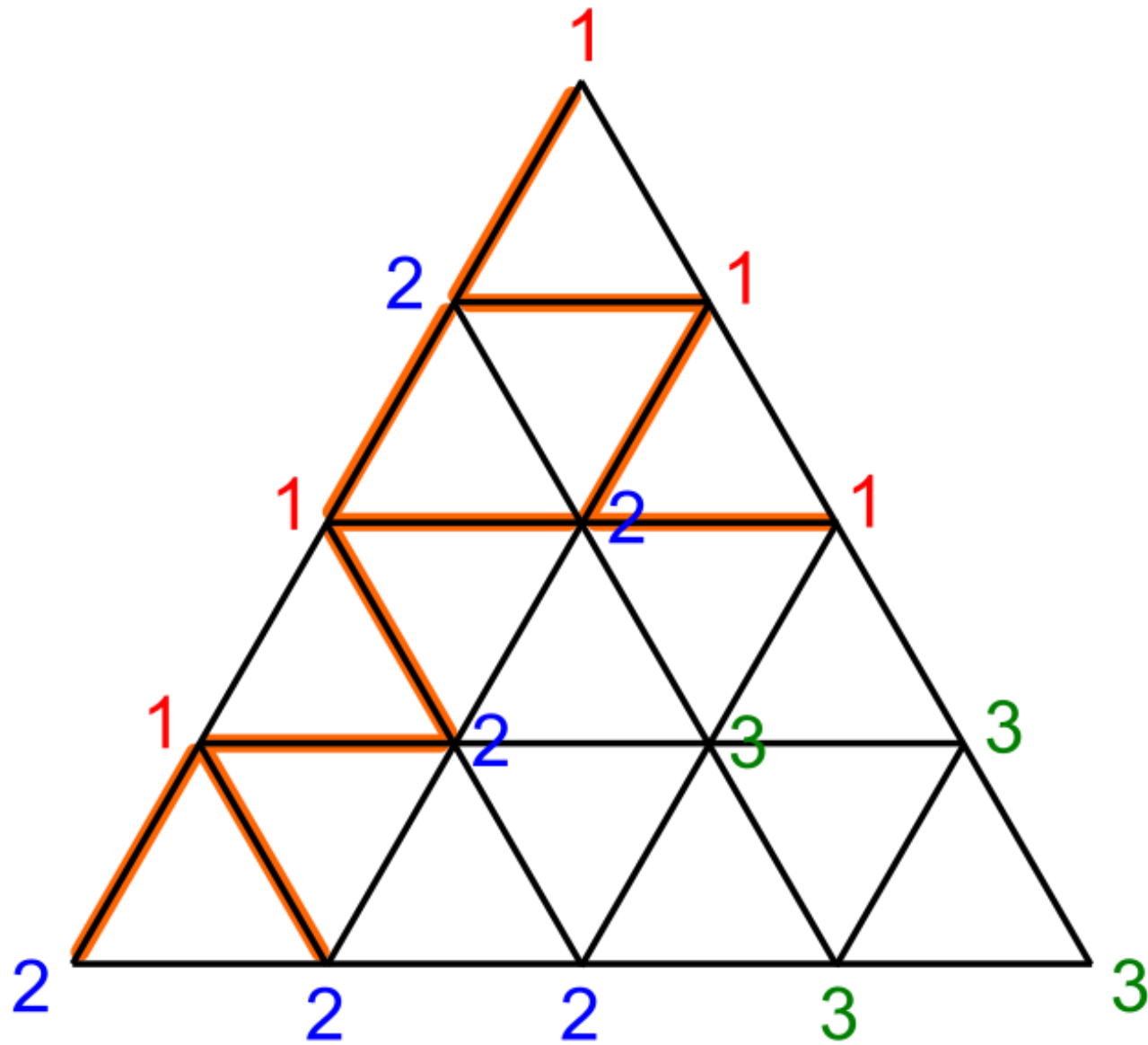

Proof Sketch of Sperner's Lemma

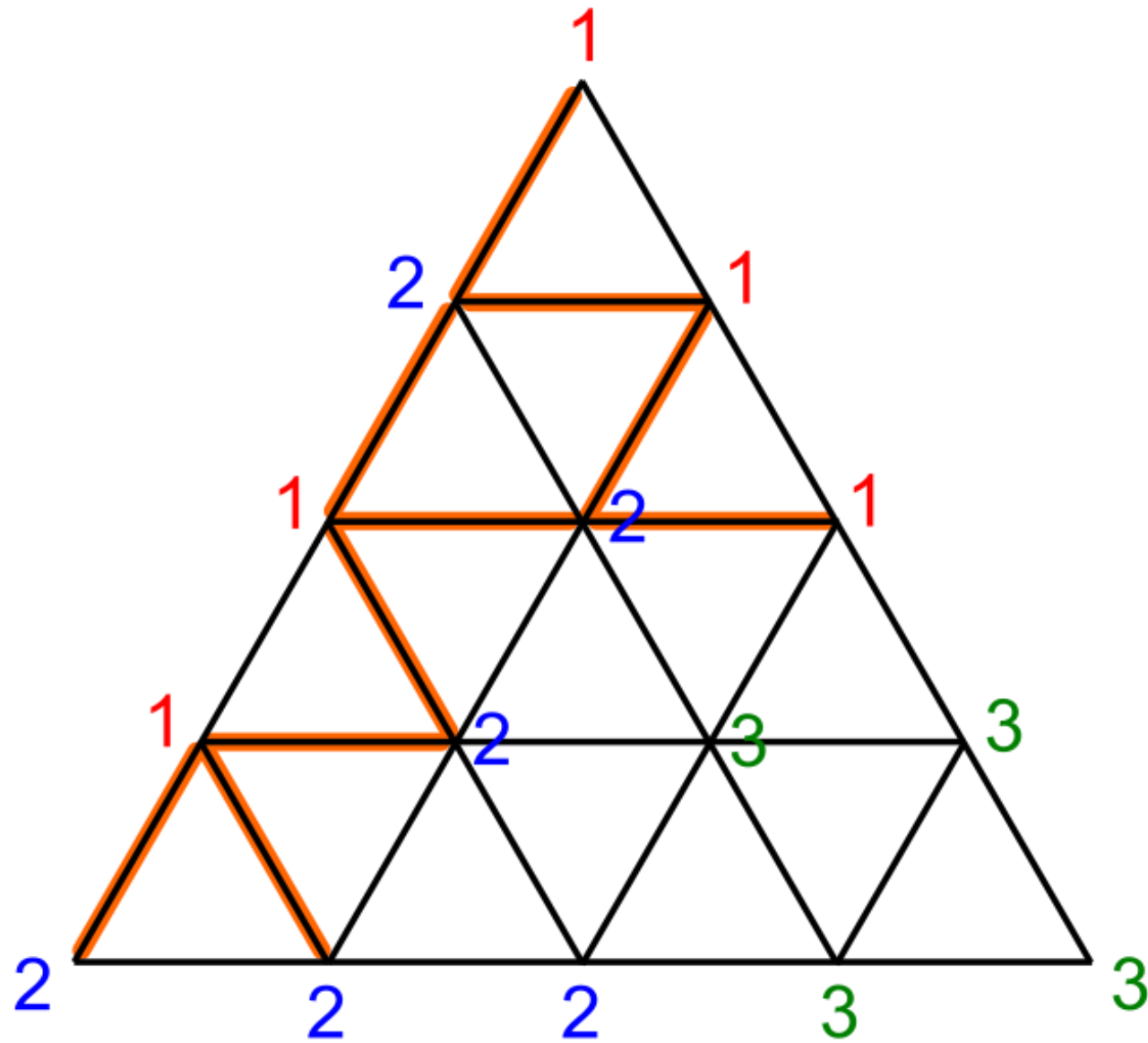

Call any 1—2 edge a "door".

Call any elementary triangle a "room".

Proof Sketch of Sperner's Lemma

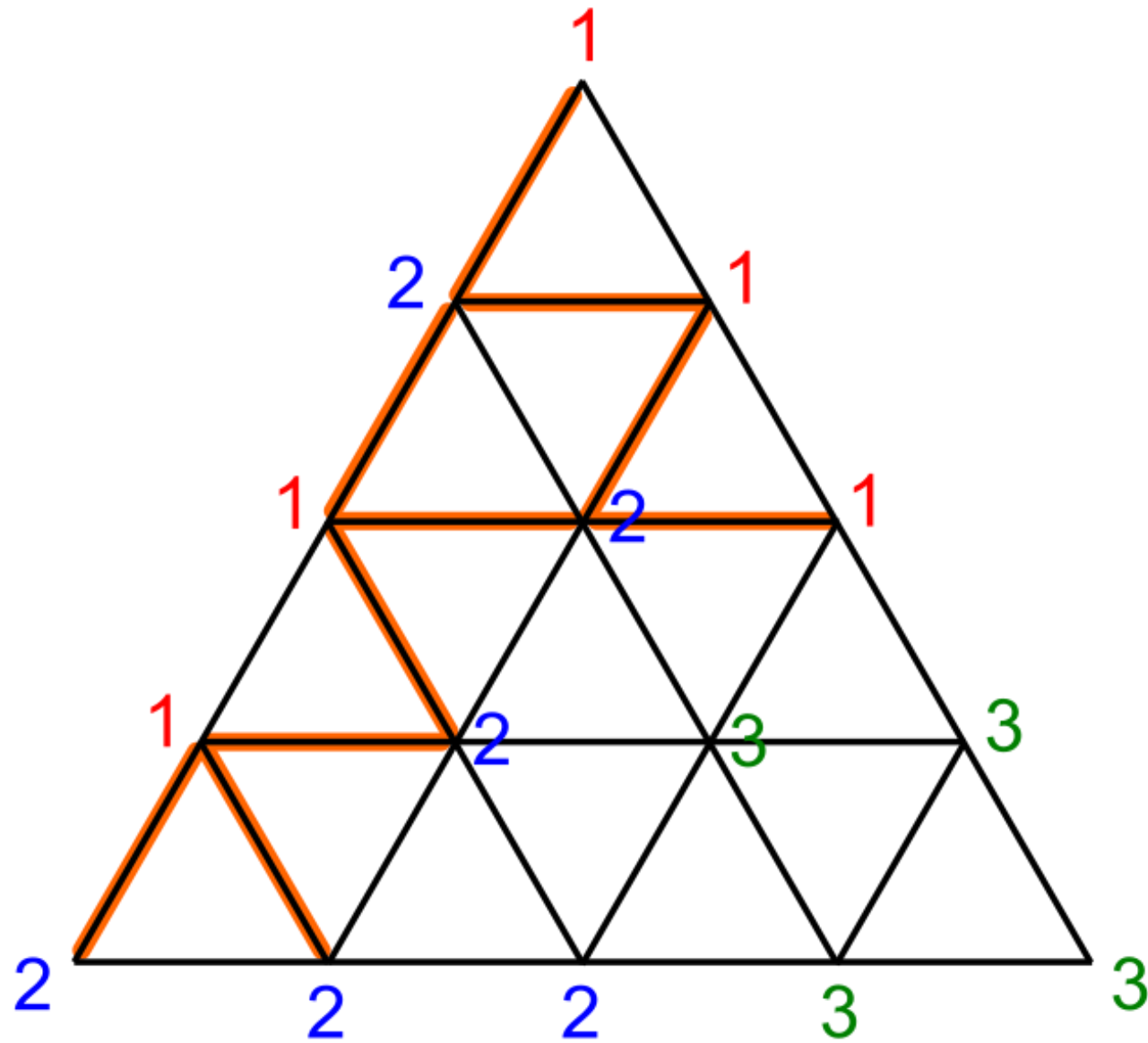

Call any 1—2 edge a "door".

Call any elementary triangle a "room".

Observe:

- No. of doors on the boundary is odd.

Proof Sketch of Sperner's Lemma

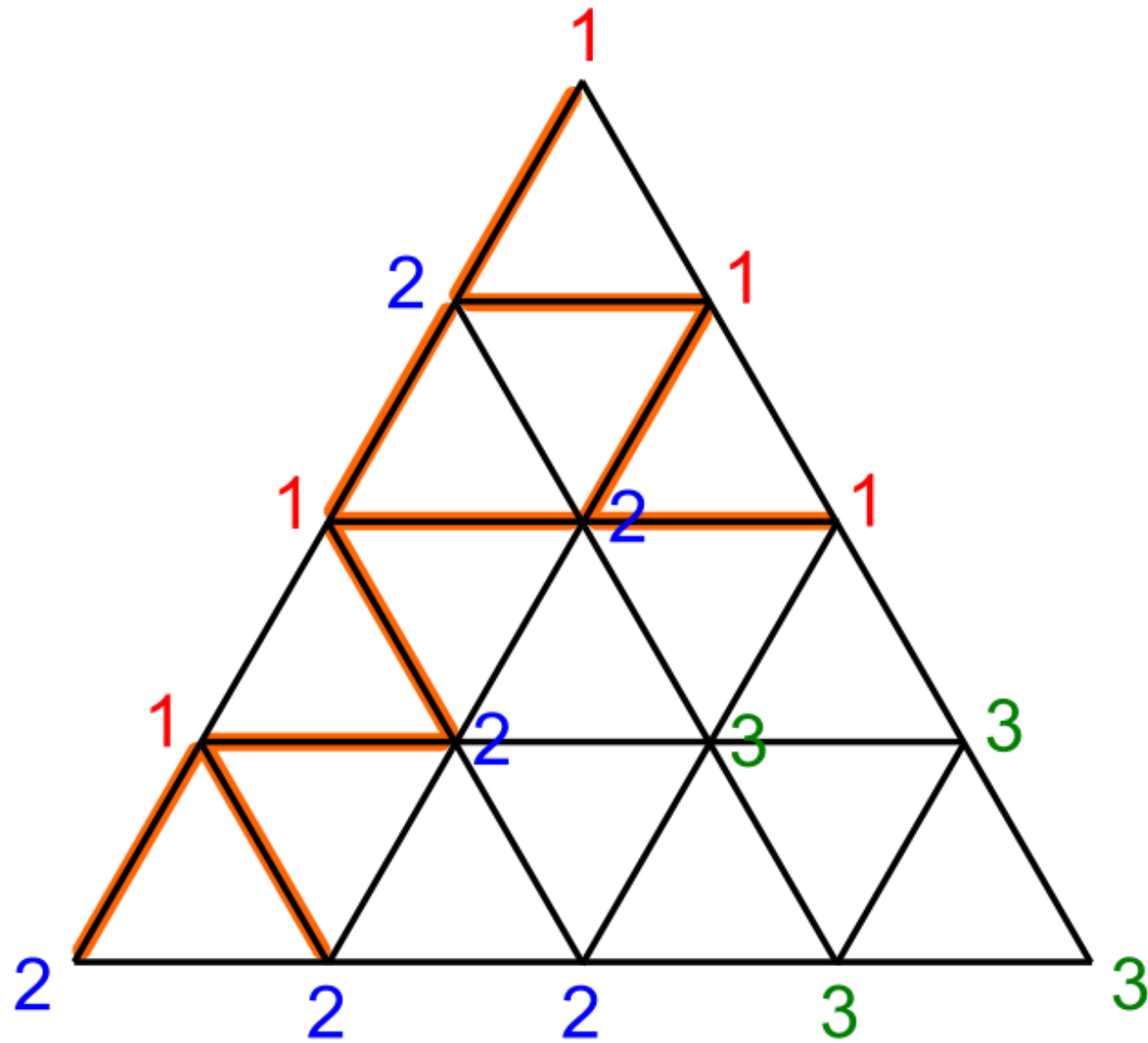

Call any 1—2 edge a "door".

Call any elementary triangle a "room".

Observe:

- No. of doors on the boundary is odd.
- A room can have zero, one, or two doors.

Proof Sketch of Sperner's Lemma

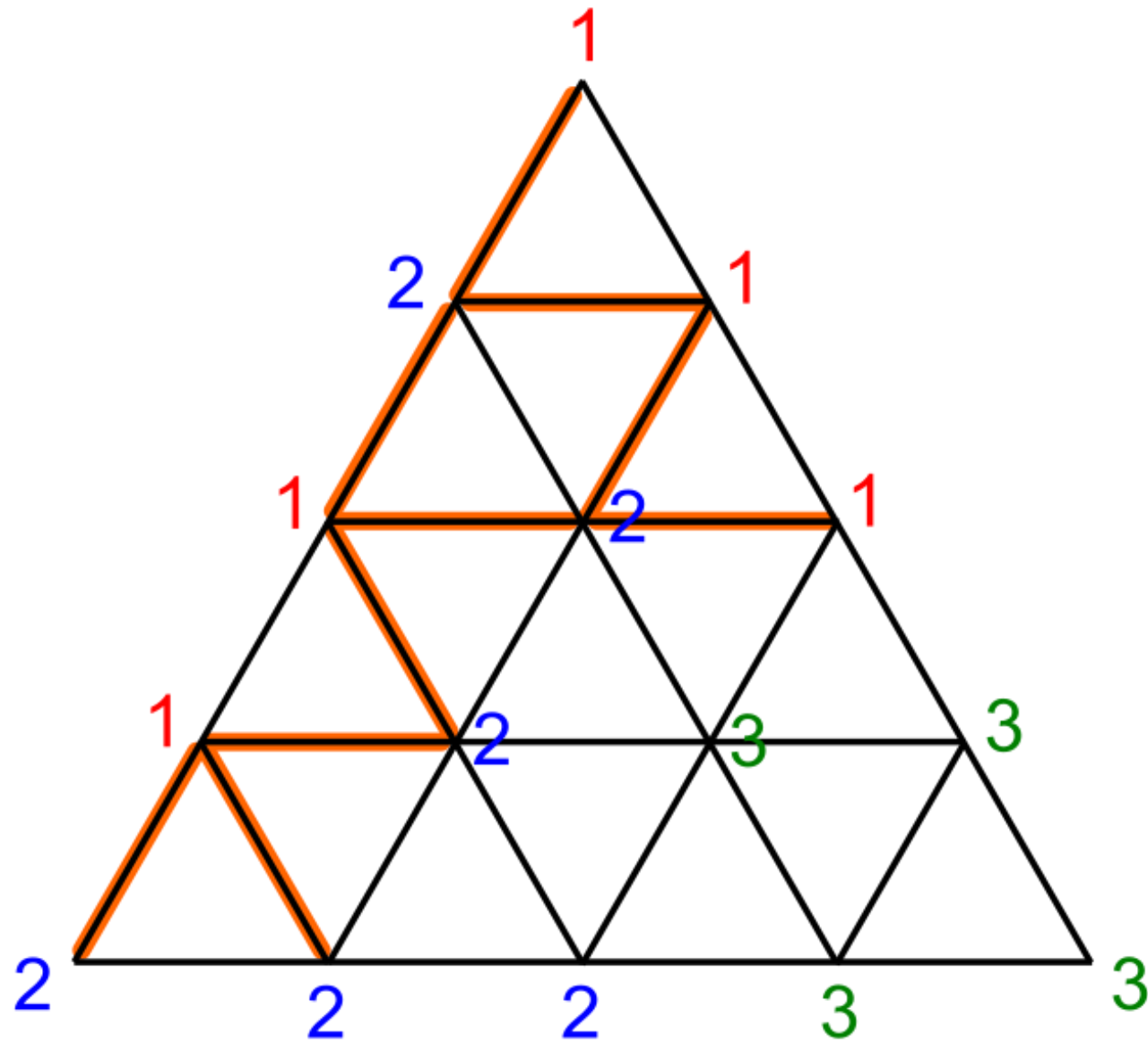

Call any 1—2 edge a "door".

Call any elementary triangle a "room".

Observe:

- No. of doors on the boundary is odd.
- A room can have zero, one, or two doors.

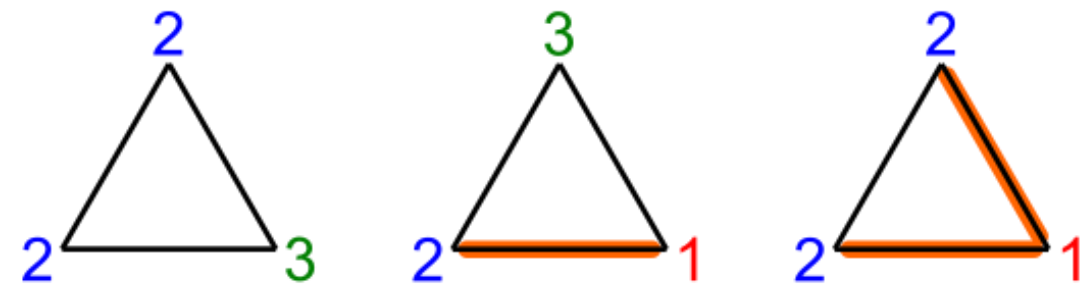

Proof Sketch of Sperner's Lemma

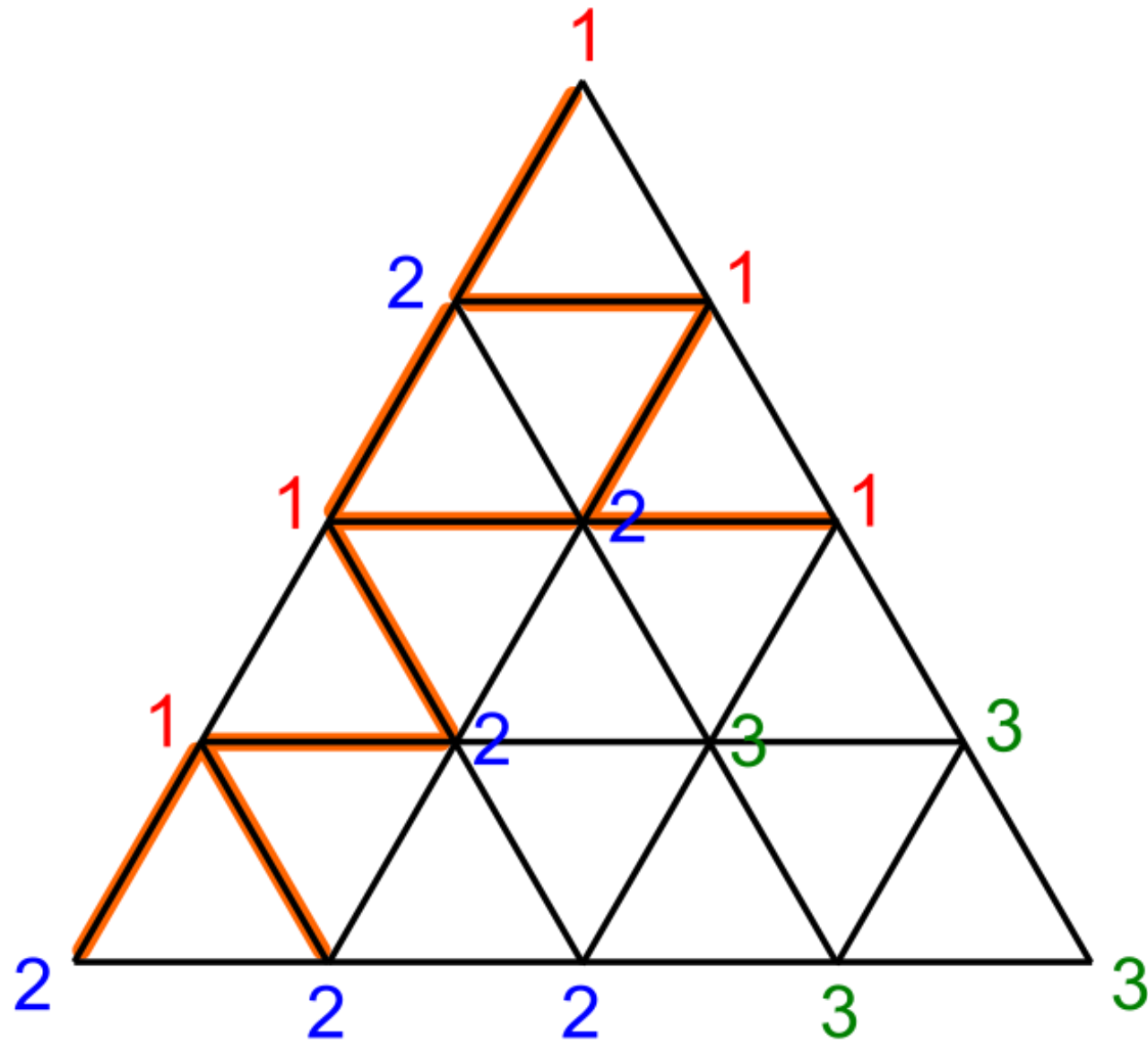

Call any 1—2 edge a "door".

Call any elementary triangle a "room".

Observe:

- No. of doors on the boundary is odd.
- A room can have zero, one, or two doors.

Proof Sketch of Sperner's Lemma

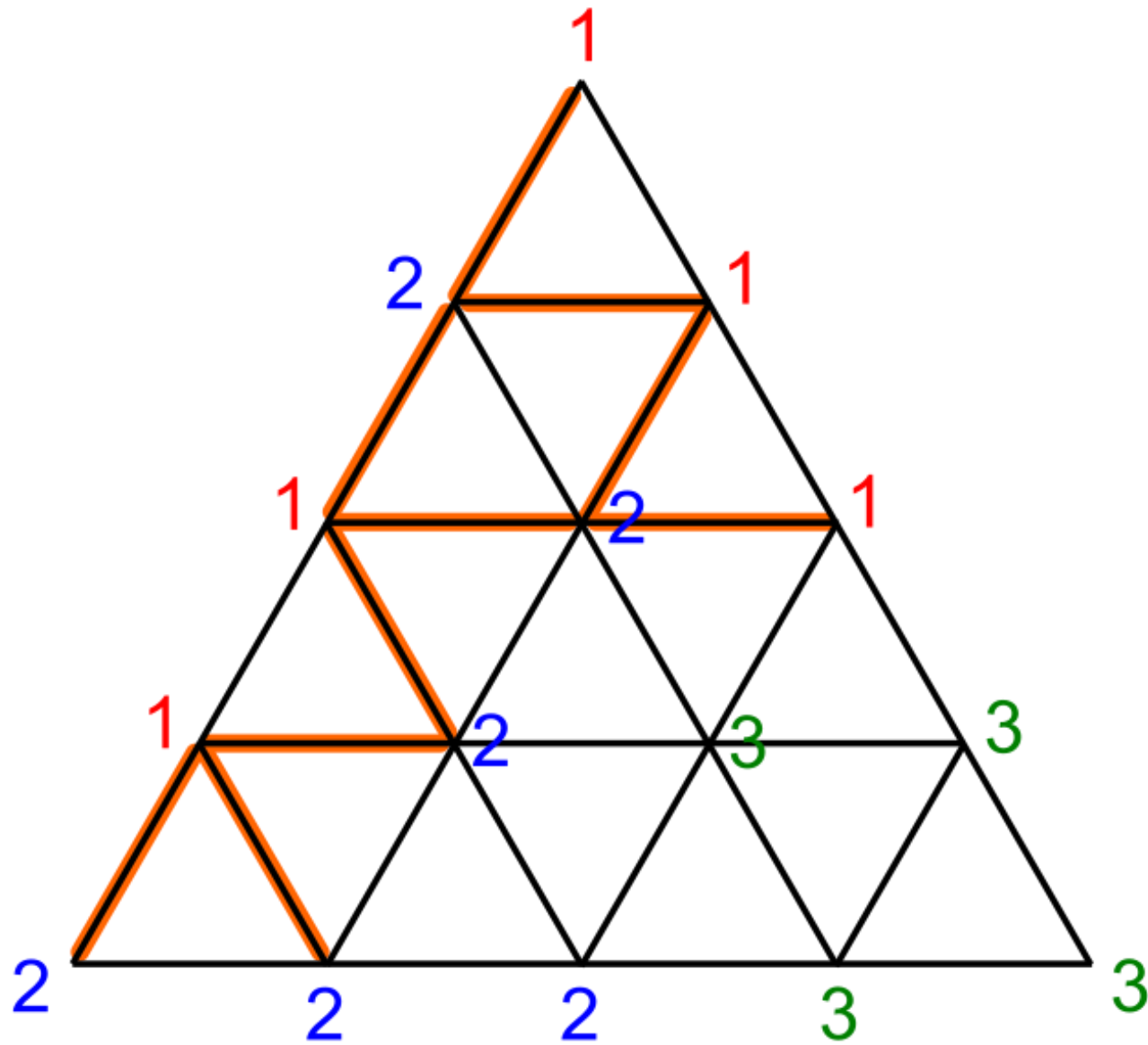

Call any 1—2 edge a "door".

Call any elementary triangle a "room".

Observe:

- No. of doors on the boundary is odd.
- A room can have zero, one, or two doors.

Room with one door \Leftrightarrow
Fully-labeled elementary triangle

Proof Sketch of Sperner's Lemma

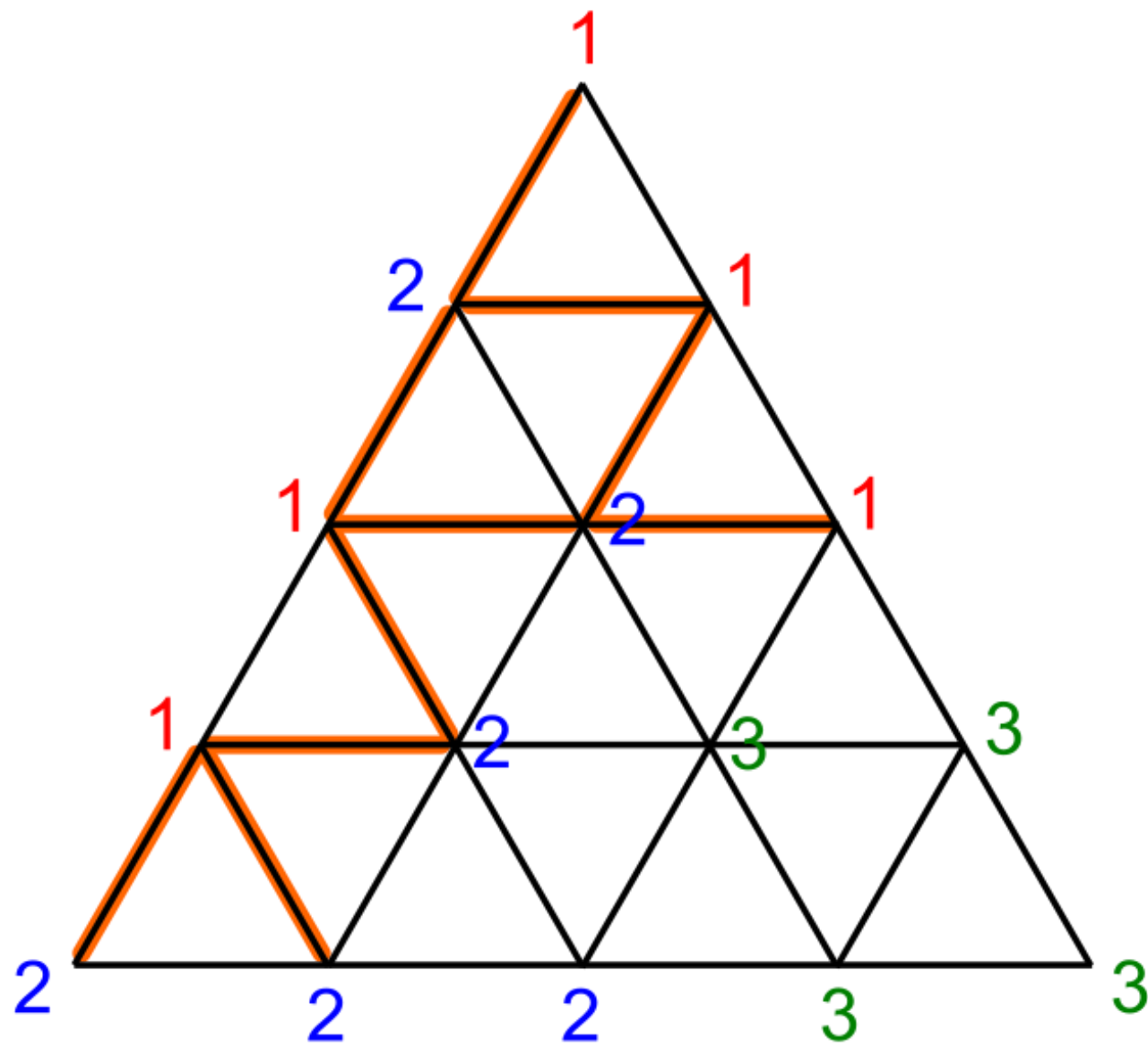

Call any 1—2 edge a "door".

Call any elementary triangle a "room".

Proof Sketch of Sperner's Lemma

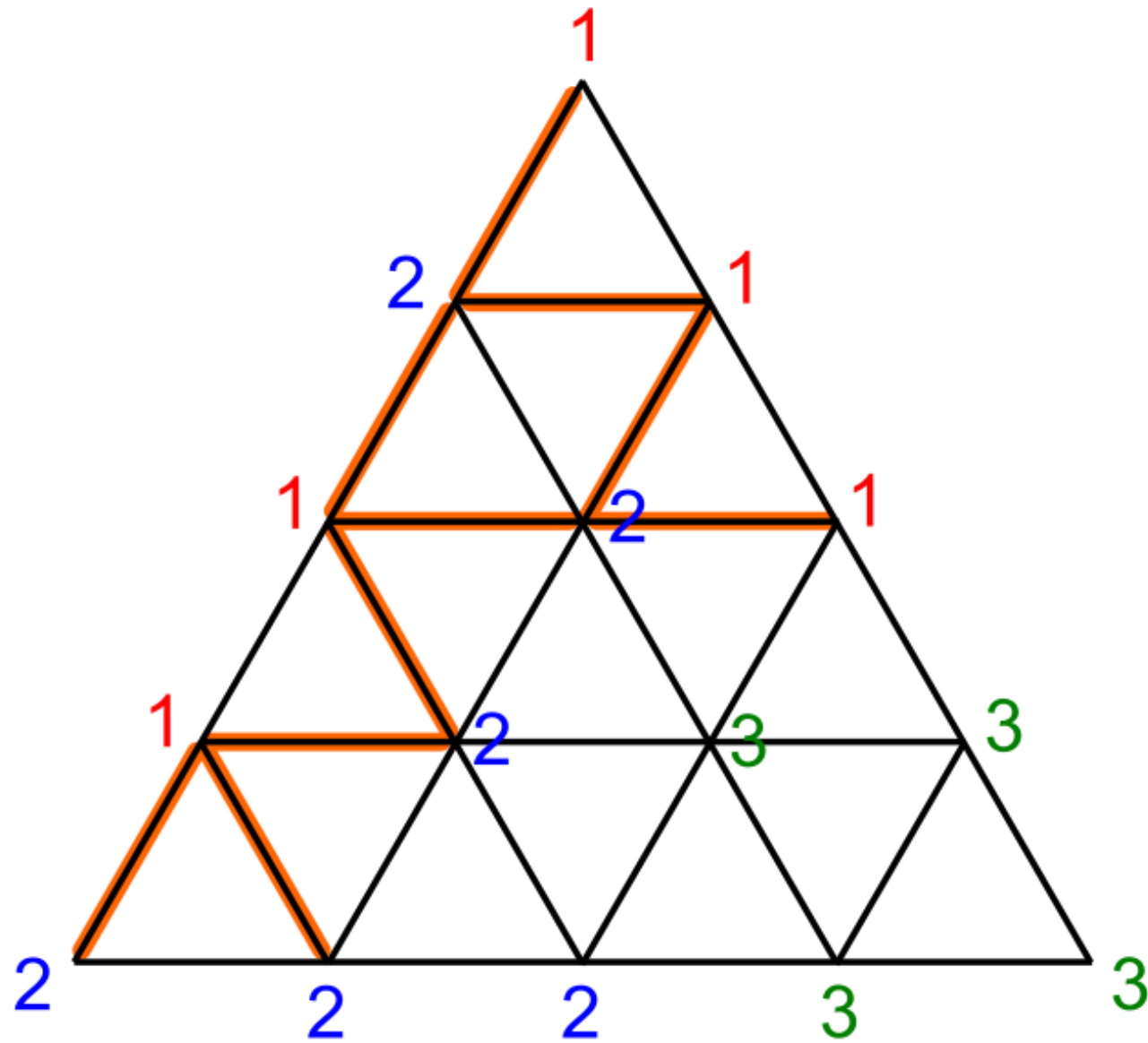

Call any 1—2 edge a "door".

Call any elementary triangle a "room".

Start walking!

Proof Sketch of Sperner's Lemma

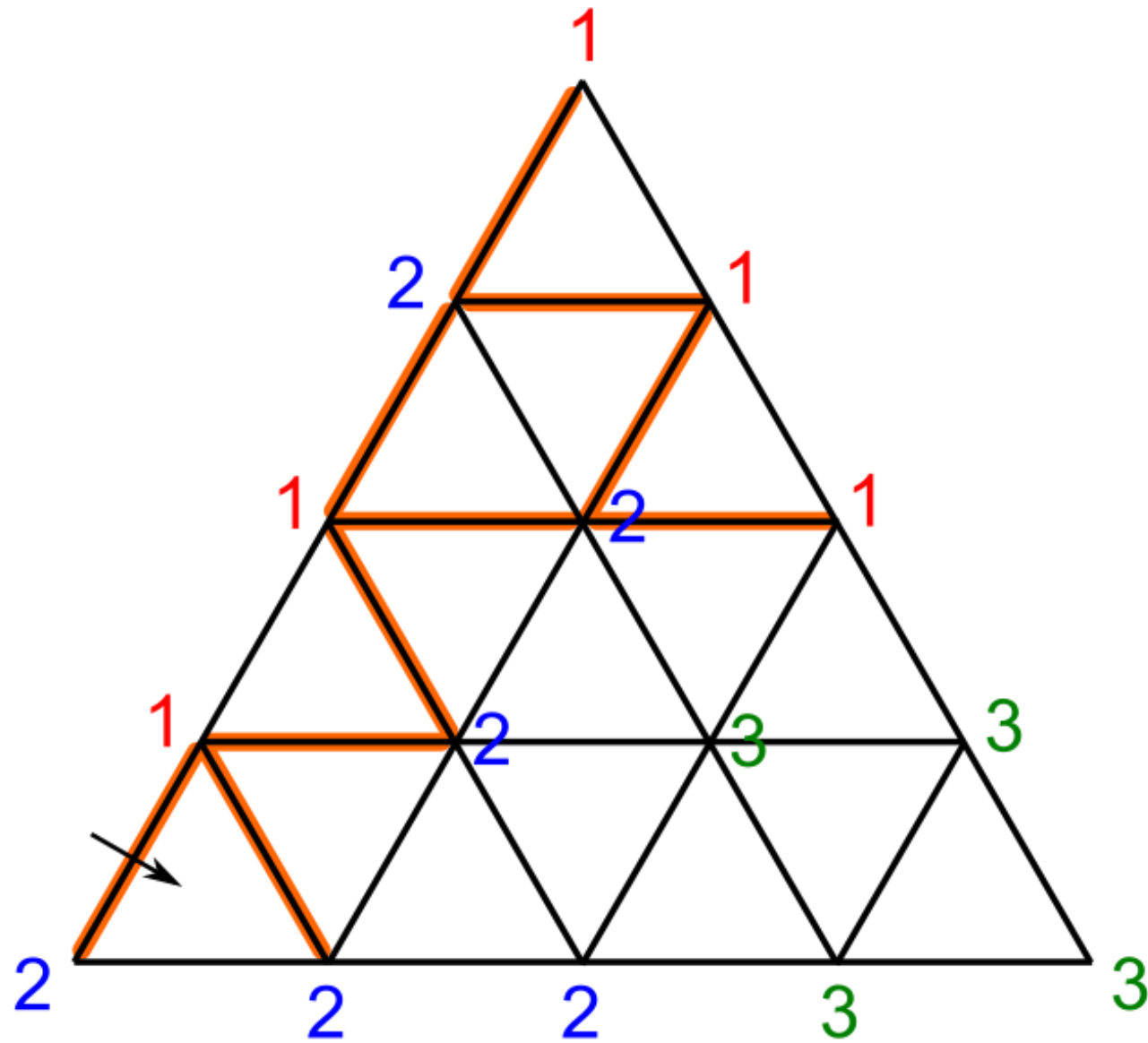

Call any 1—2 edge a "door".

Call any elementary triangle a "room".

Start walking!

Proof Sketch of Sperner's Lemma

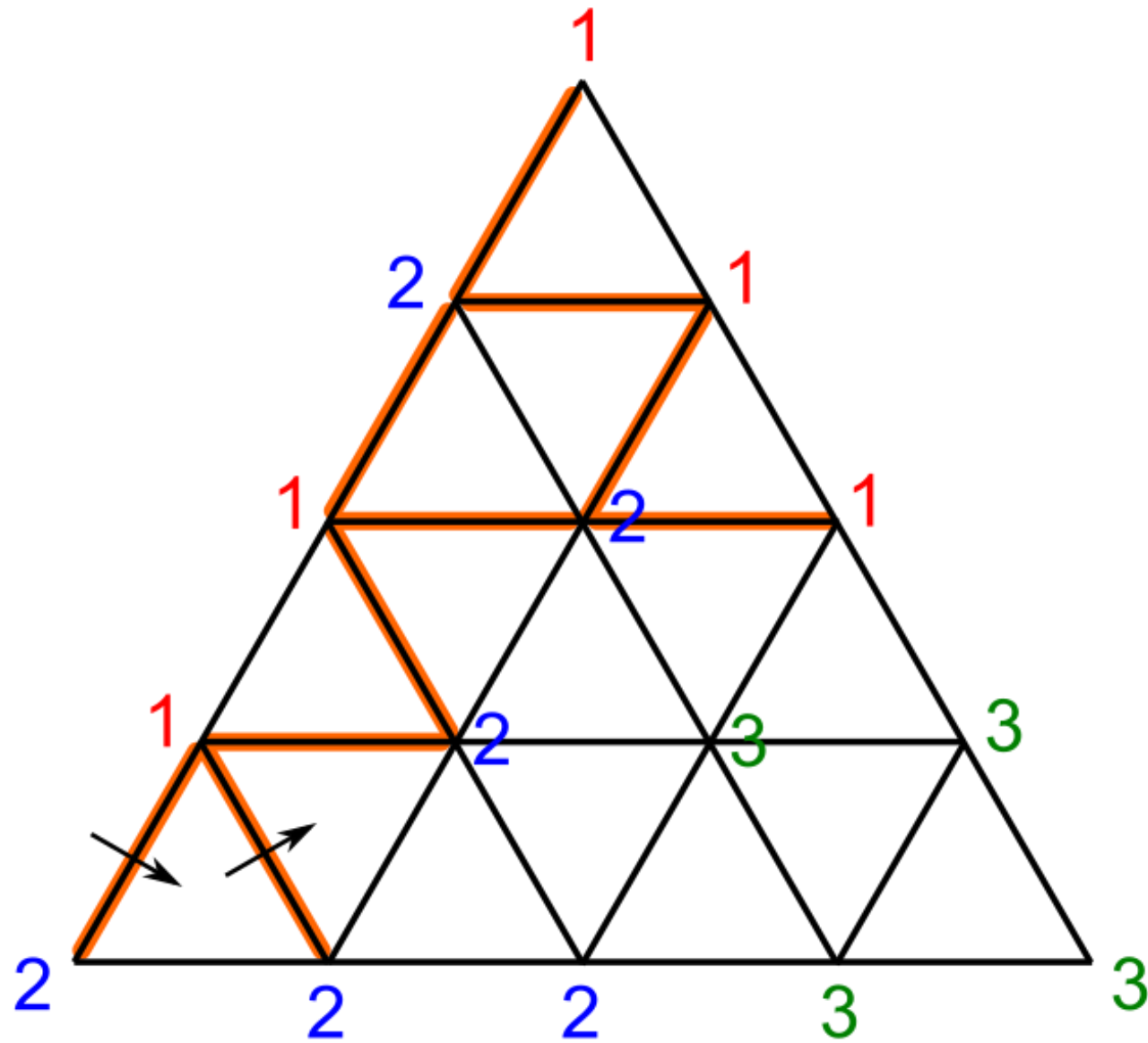

Call any 1—2 edge a "door".

Call any elementary triangle a "room".

Start walking!

Proof Sketch of Sperner's Lemma

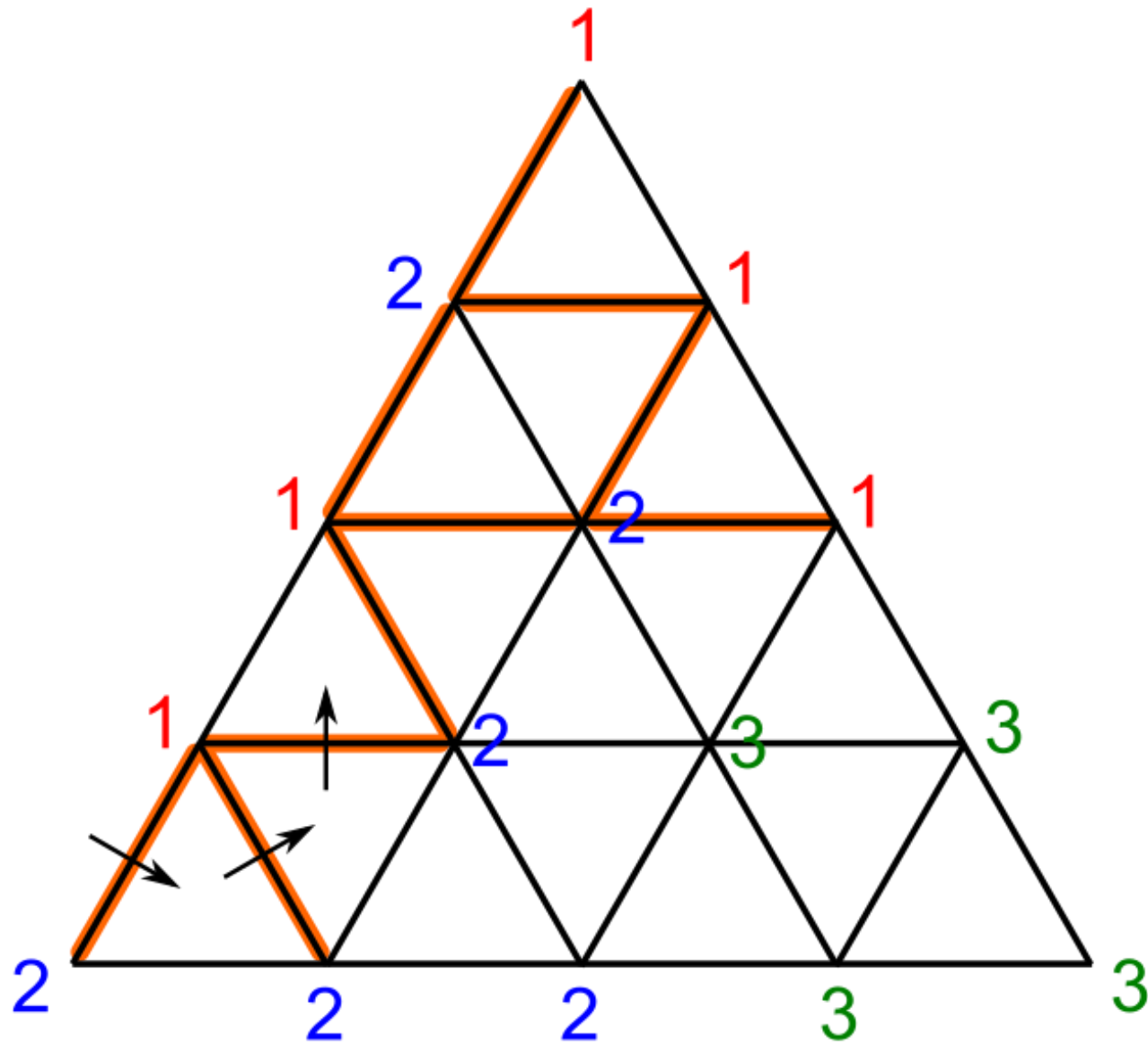

Call any 1—2 edge a "door".

Call any elementary triangle a "room".

Start walking!

Proof Sketch of Sperner's Lemma

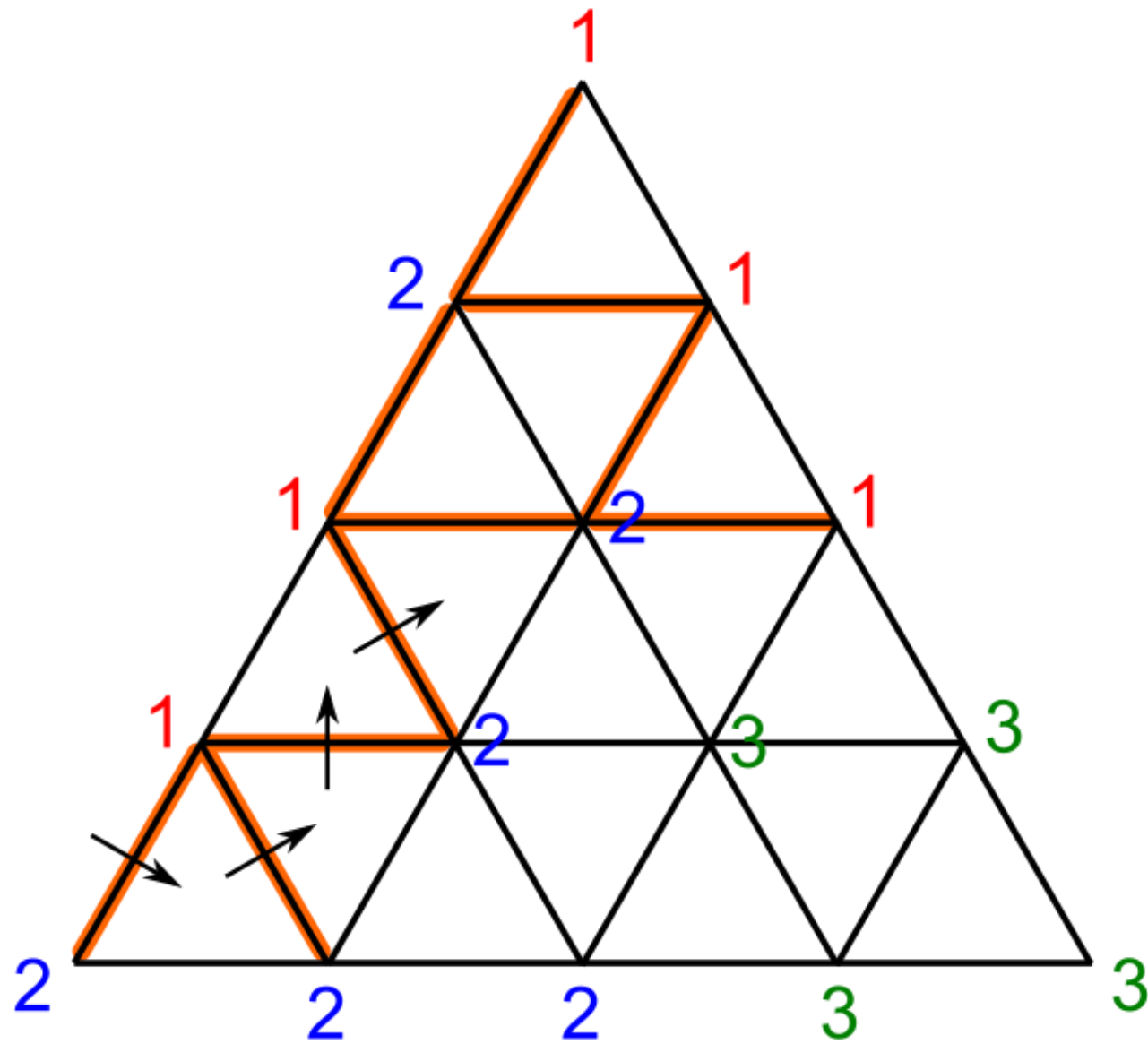

Call any 1—2 edge a "door".

Call any elementary triangle a "room".

Start walking!

Proof Sketch of Sperner's Lemma

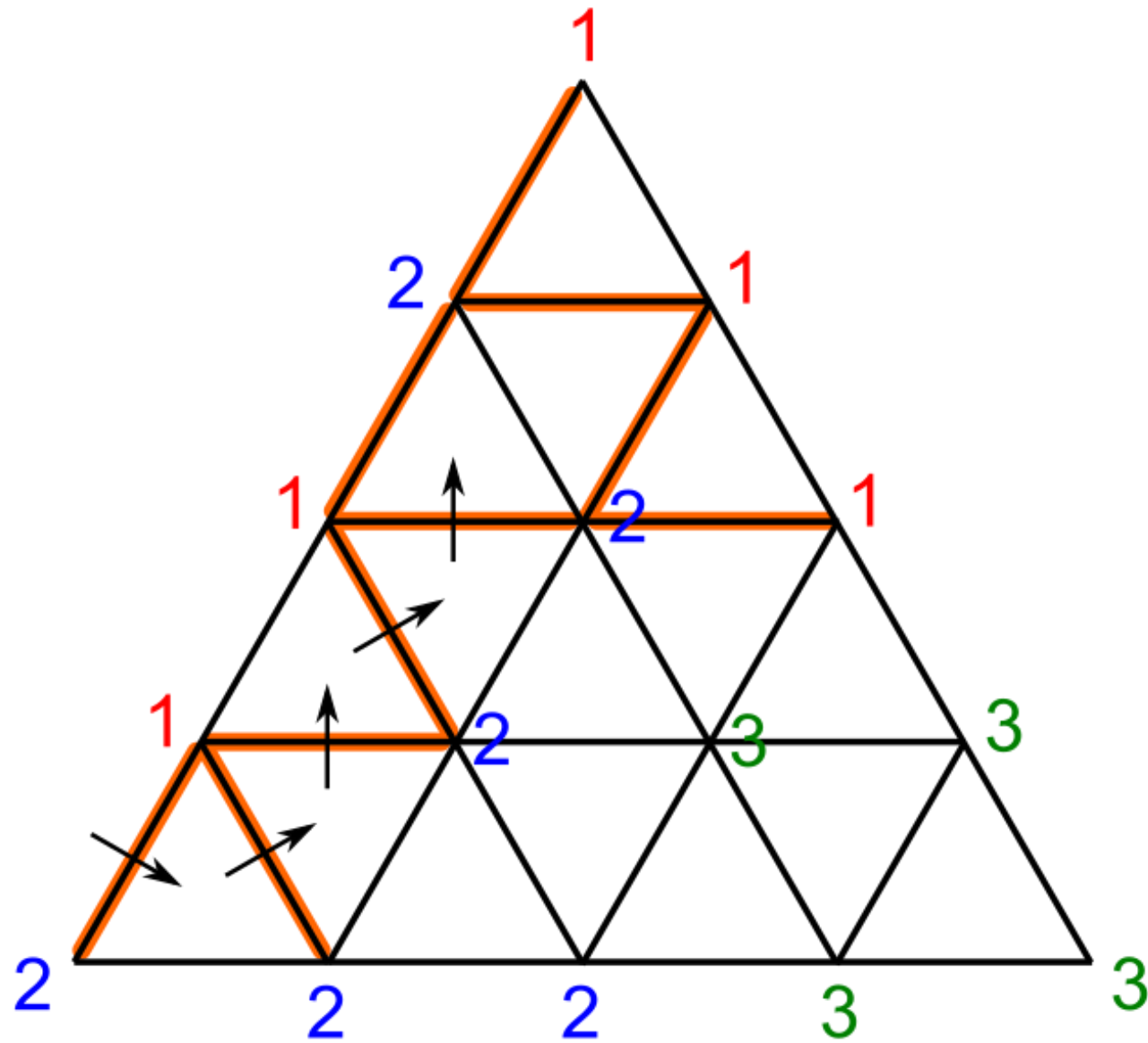

Call any 1—2 edge a "door".

Call any elementary triangle a "room".

Start walking!

Proof Sketch of Sperner's Lemma

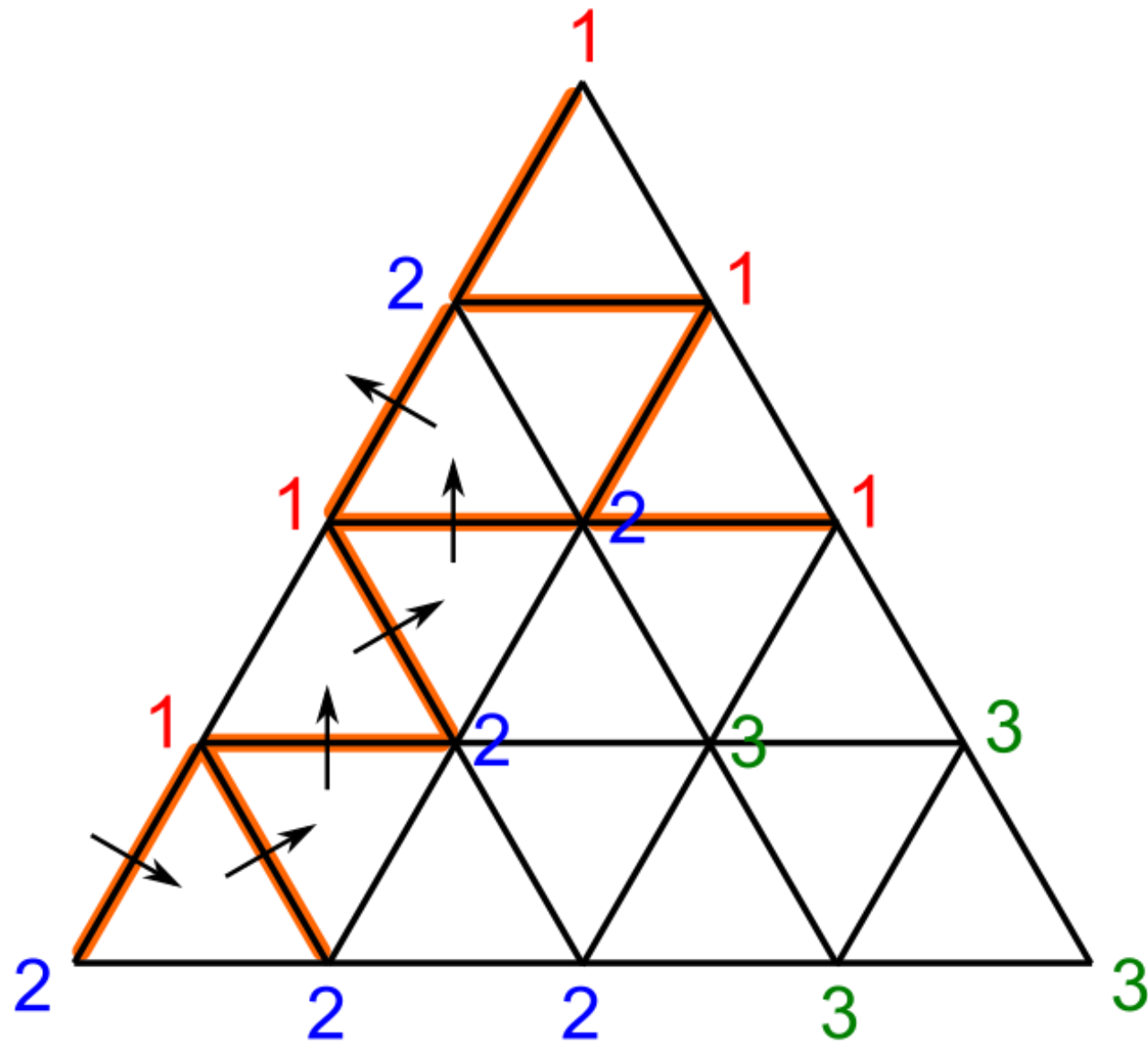

Call any 1—2 edge a "door".

Call any elementary triangle a "room".

Start walking!

Proof Sketch of Sperner's Lemma

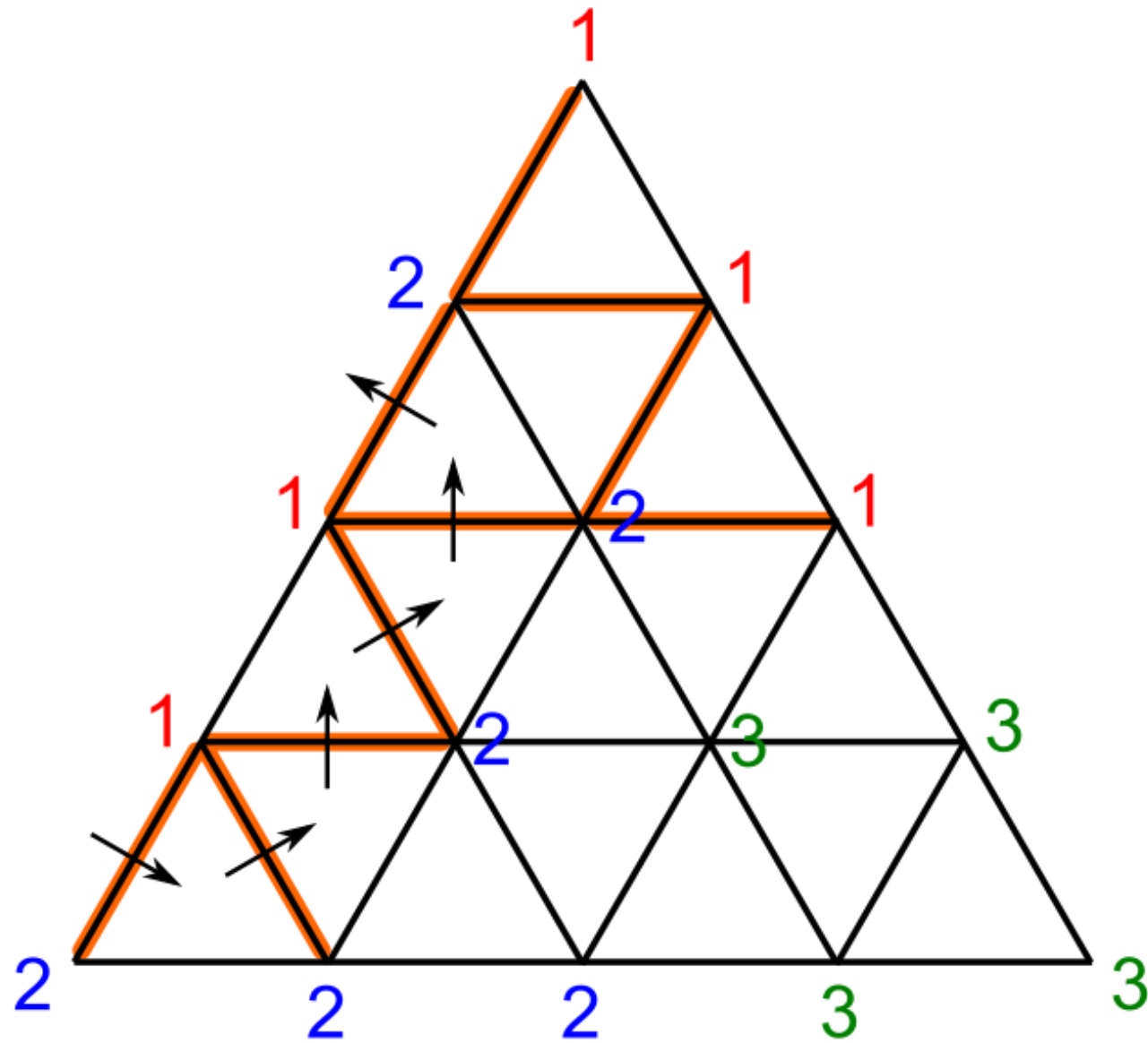

Call any 1—2 edge a "door".

Call any elementary triangle a "room".

Start walking!

- If thrown out, take another door.

Proof Sketch of Sperner's Lemma

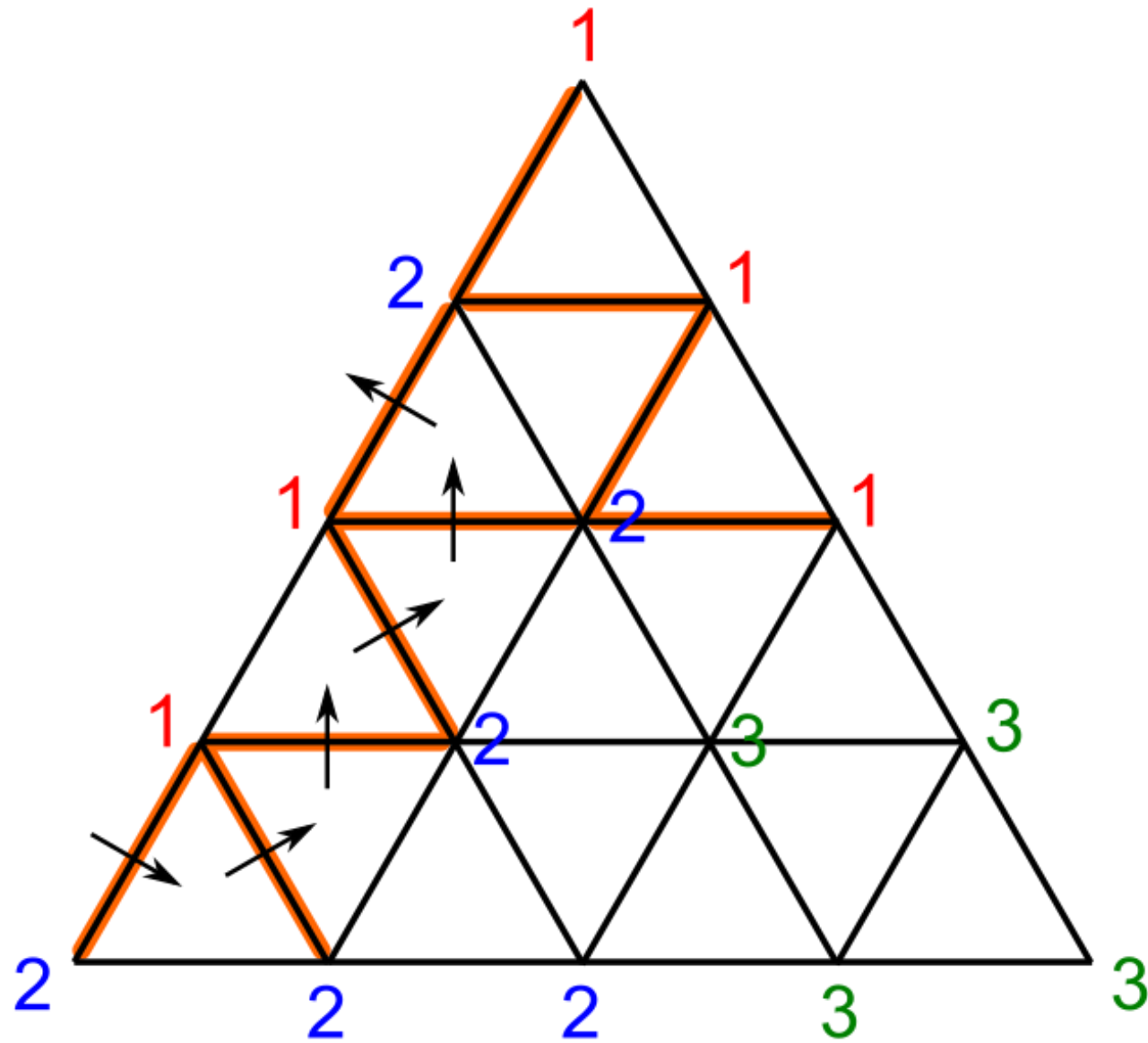

Call any 1—2 edge a "door".

Call any elementary triangle a "room".

Start walking!

- If thrown out, take another door.
- Some path must end up in a room with exactly one door.

Proof Sketch of Sperner's Lemma

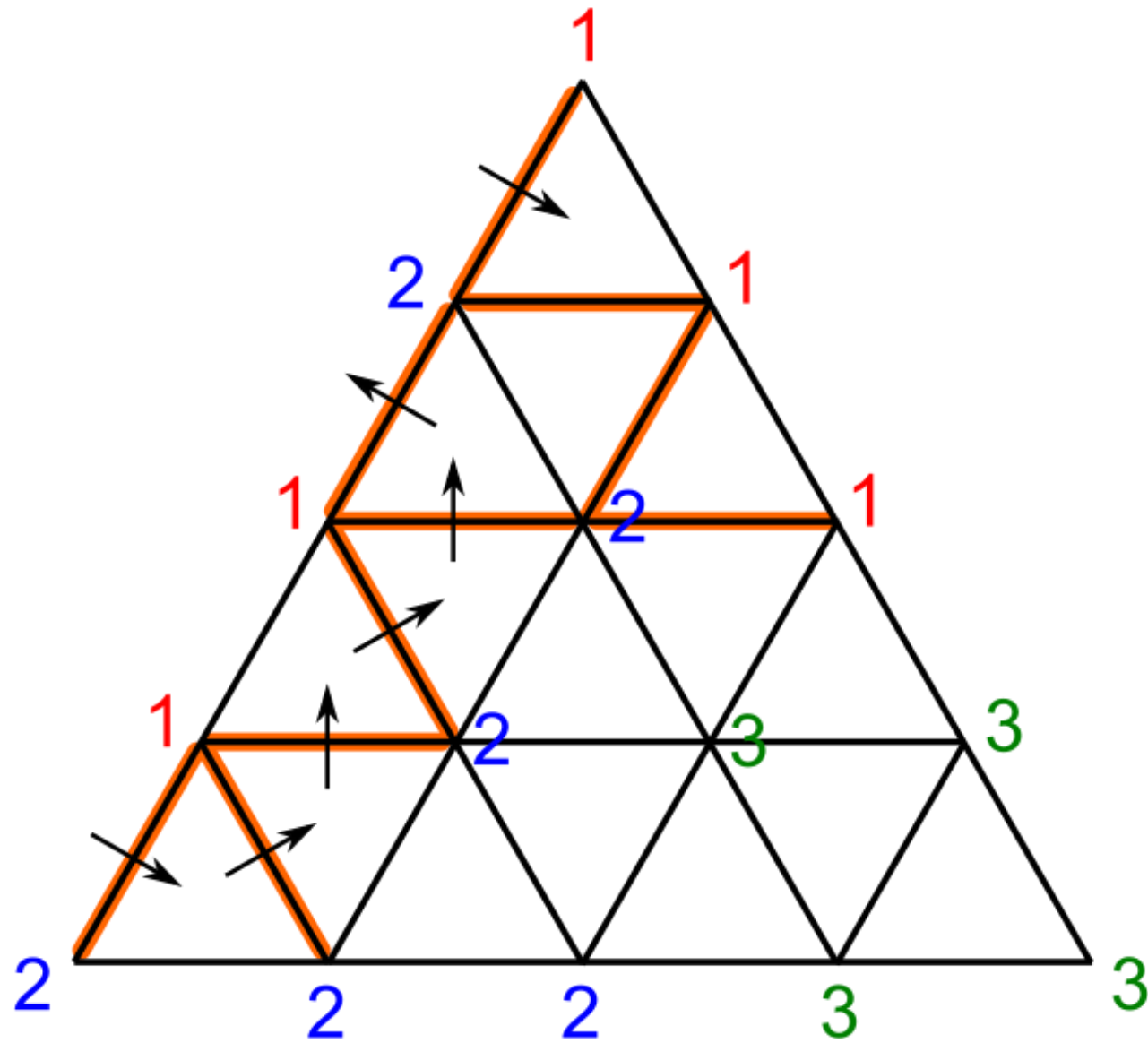

Call any 1—2 edge a "door".

Call any elementary triangle a "room".

Start walking!

- If thrown out, take another door.
- Some path must end up in a room with exactly one door.

Proof Sketch of Sperner's Lemma

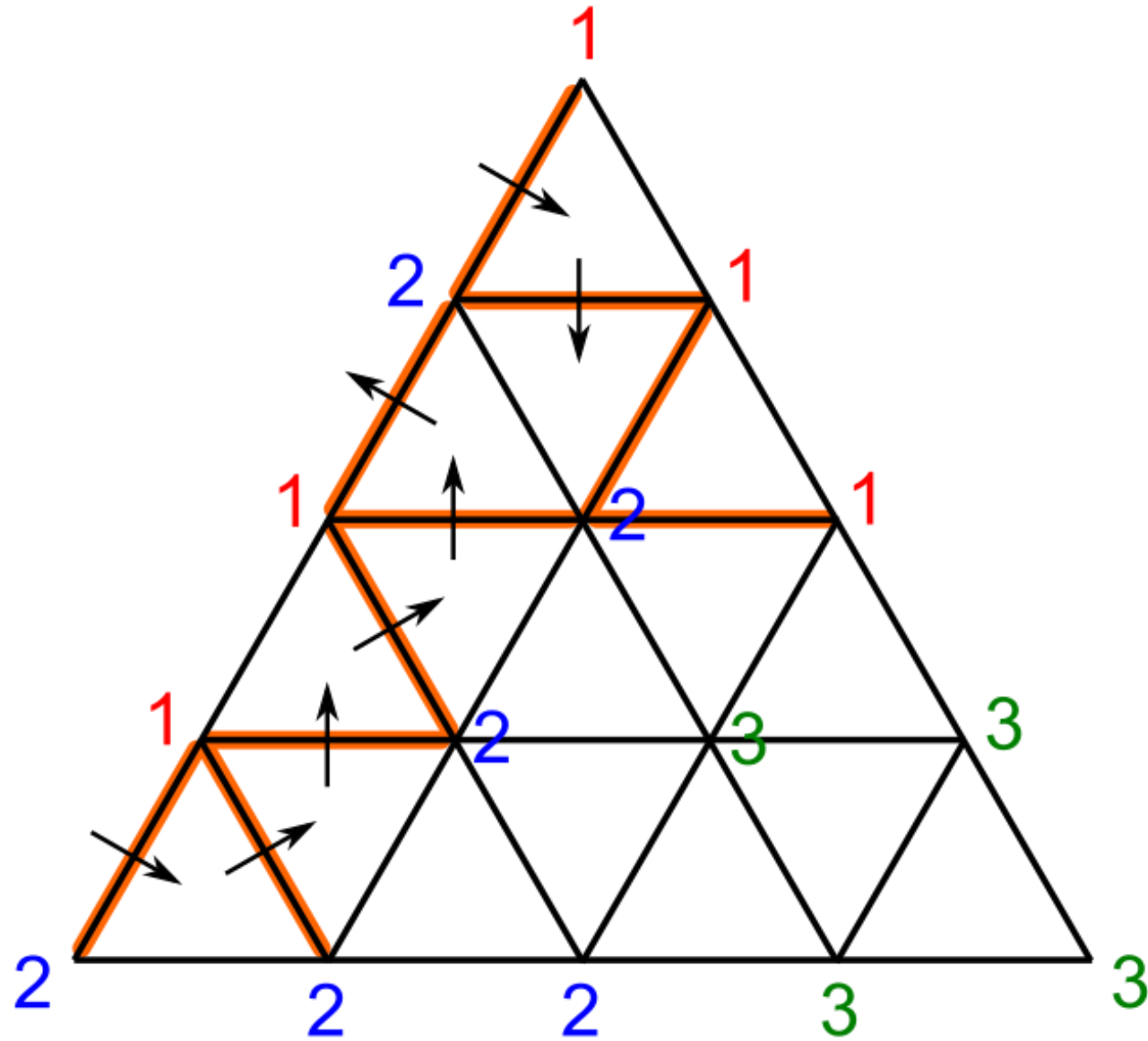

Call any 1—2 edge a "door".

Call any elementary triangle a "room".

Start walking!

- If thrown out, take another door.
- Some path must end up in a room with exactly one door.

Proof Sketch of Sperner's Lemma

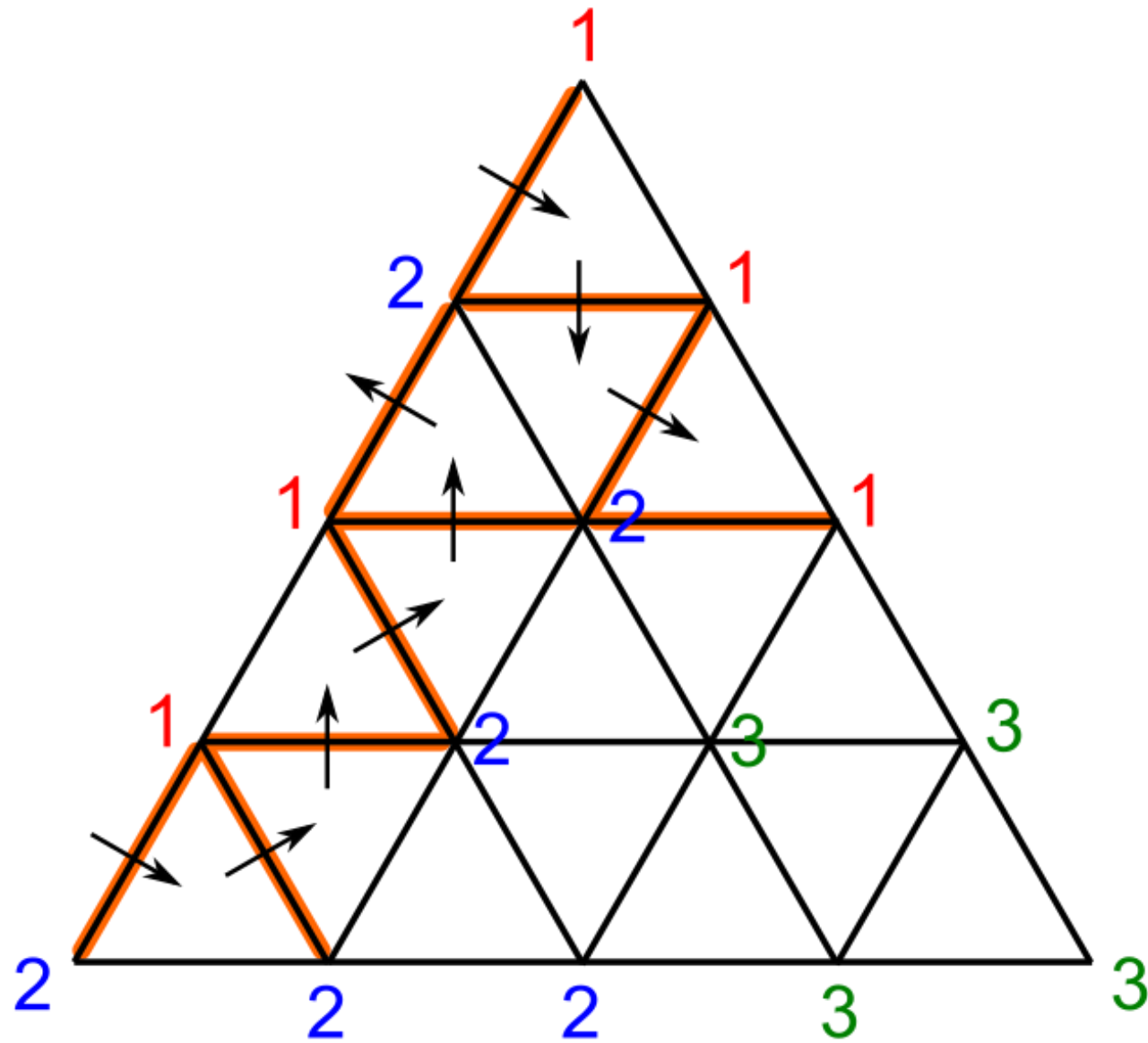

Call any 1—2 edge a "door".

Call any elementary triangle a "room".

Start walking!

- If thrown out, take another door.
- Some path must end up in a room with exactly one door.

Proof Sketch of Sperner's Lemma

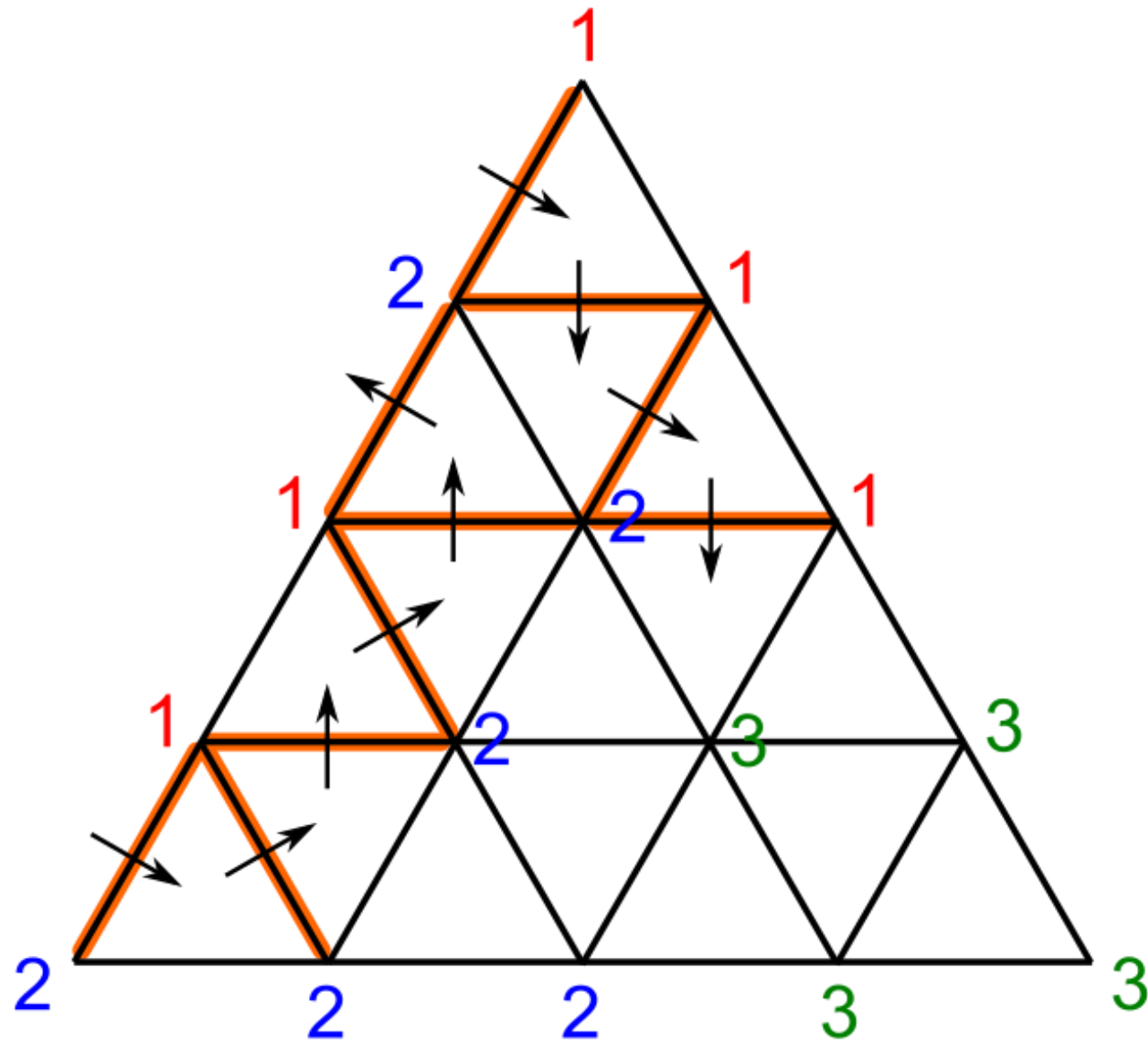

Call any 1—2 edge a "door".

Call any elementary triangle a "room".

Start walking!

- If thrown out, take another door.
- Some path must end up in a room with exactly one door.

Proof Sketch of Sperner's Lemma

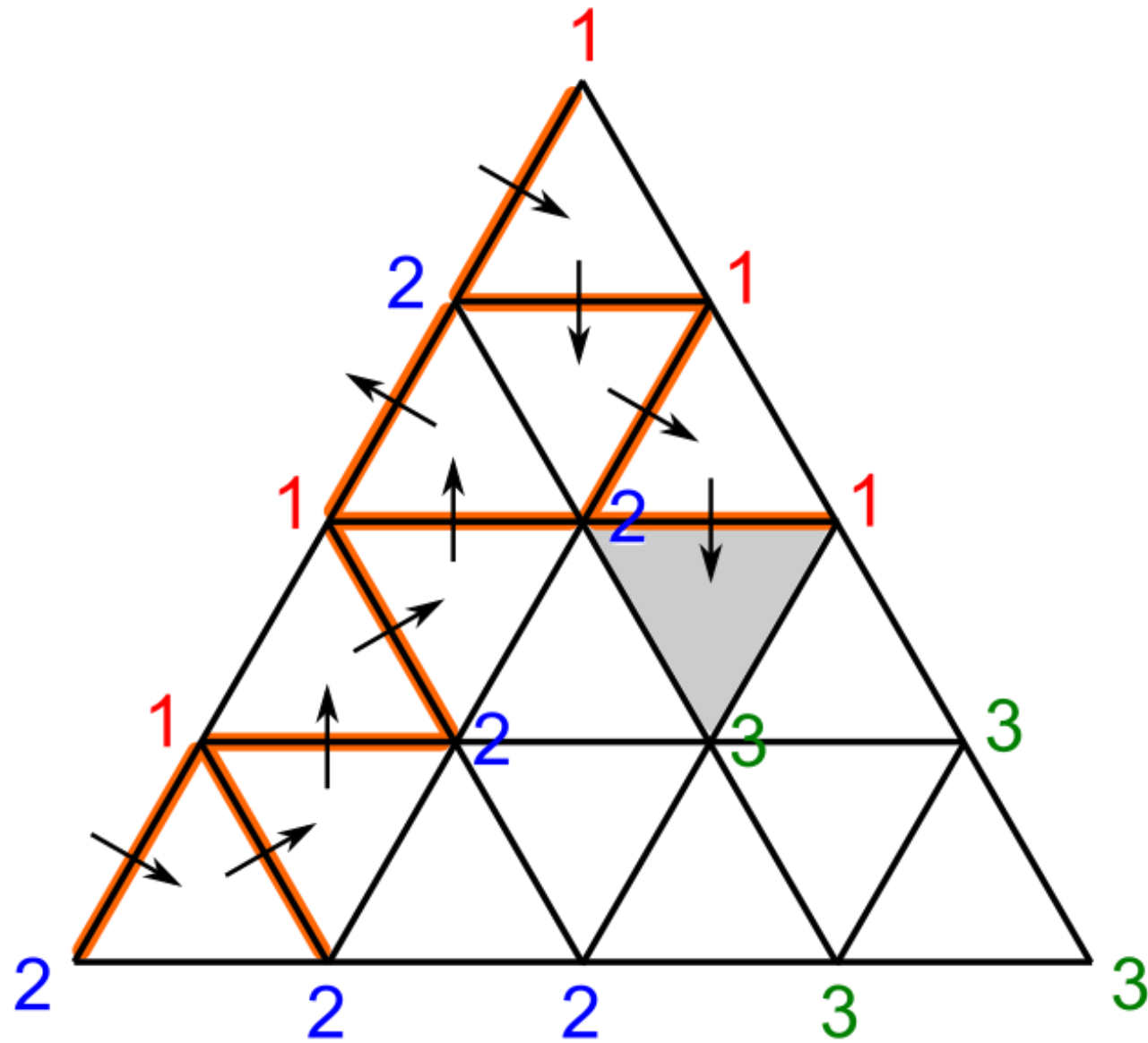

Call any 1—2 edge a "door".

Call any elementary triangle a "room".

Start walking!

- If thrown out, take another door.
- Some path must end up in a room with exactly one door.

Proof Sketch of Sperner's Lemma

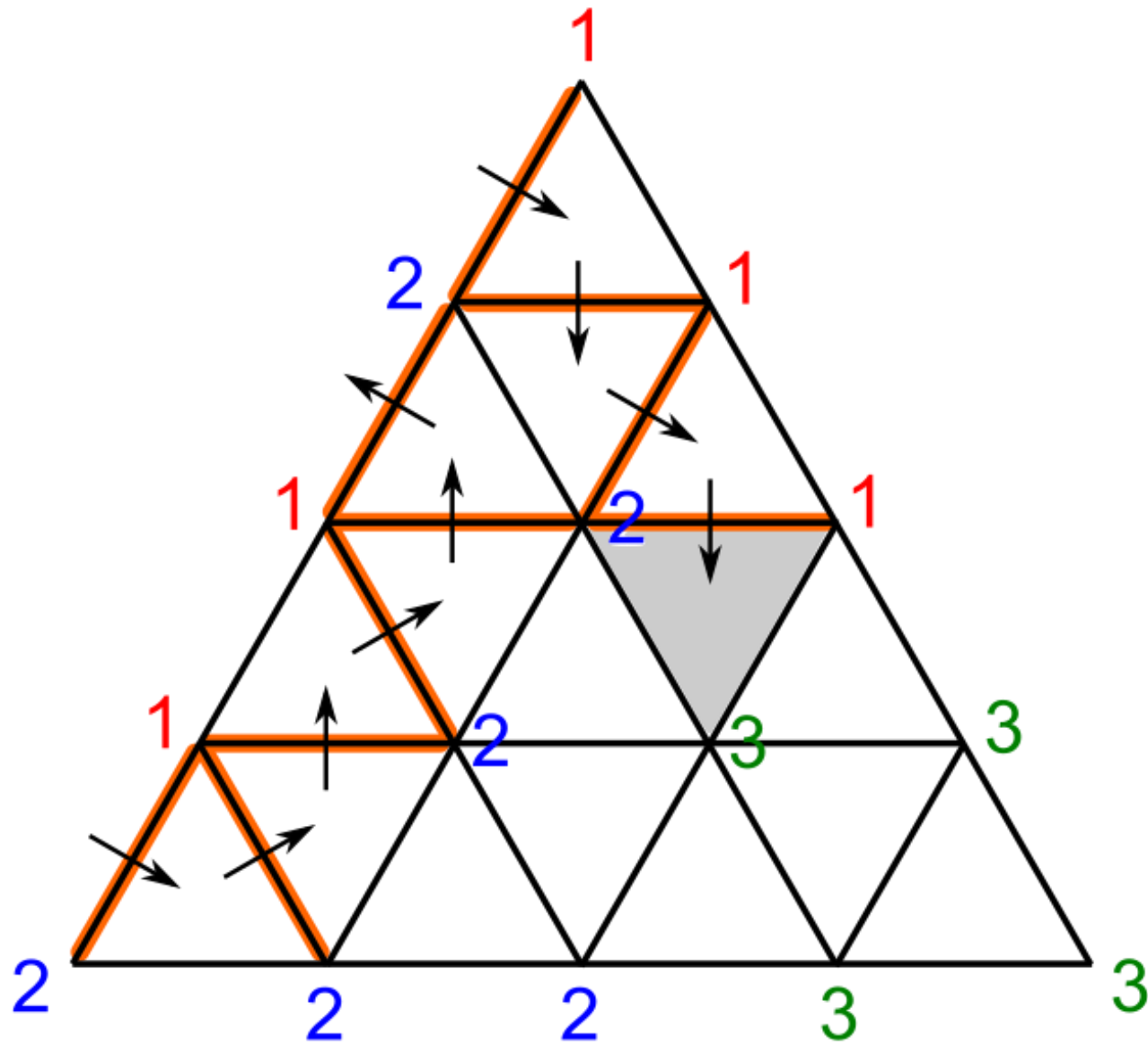

Call any 1—2 edge a "door".

Call any elementary triangle a "room".

Start walking!

- If thrown out, take another door.
- Some path must end up in a room with exactly one door.

Why can't such a walk cycle?

Proof Sketch of Sperner's Lemma

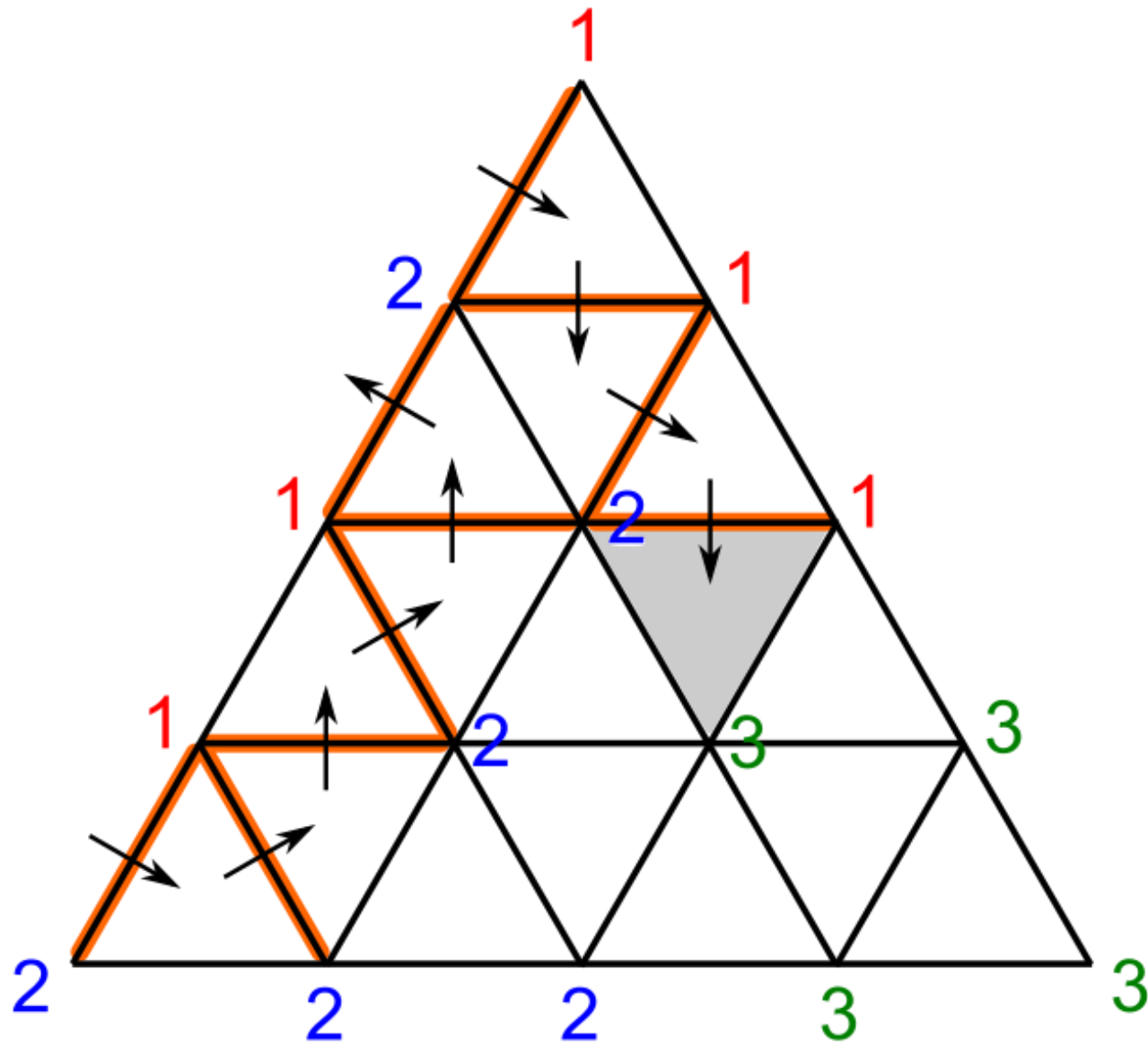

Call any 1—2 edge a "door".

Call any elementary triangle a "room".

Start walking!

- If thrown out, take another door.
- Some path must end up in a room with exactly one door.

Why can't such a walk cycle? Exercise.

Proof Sketch of Sperner's Lemma

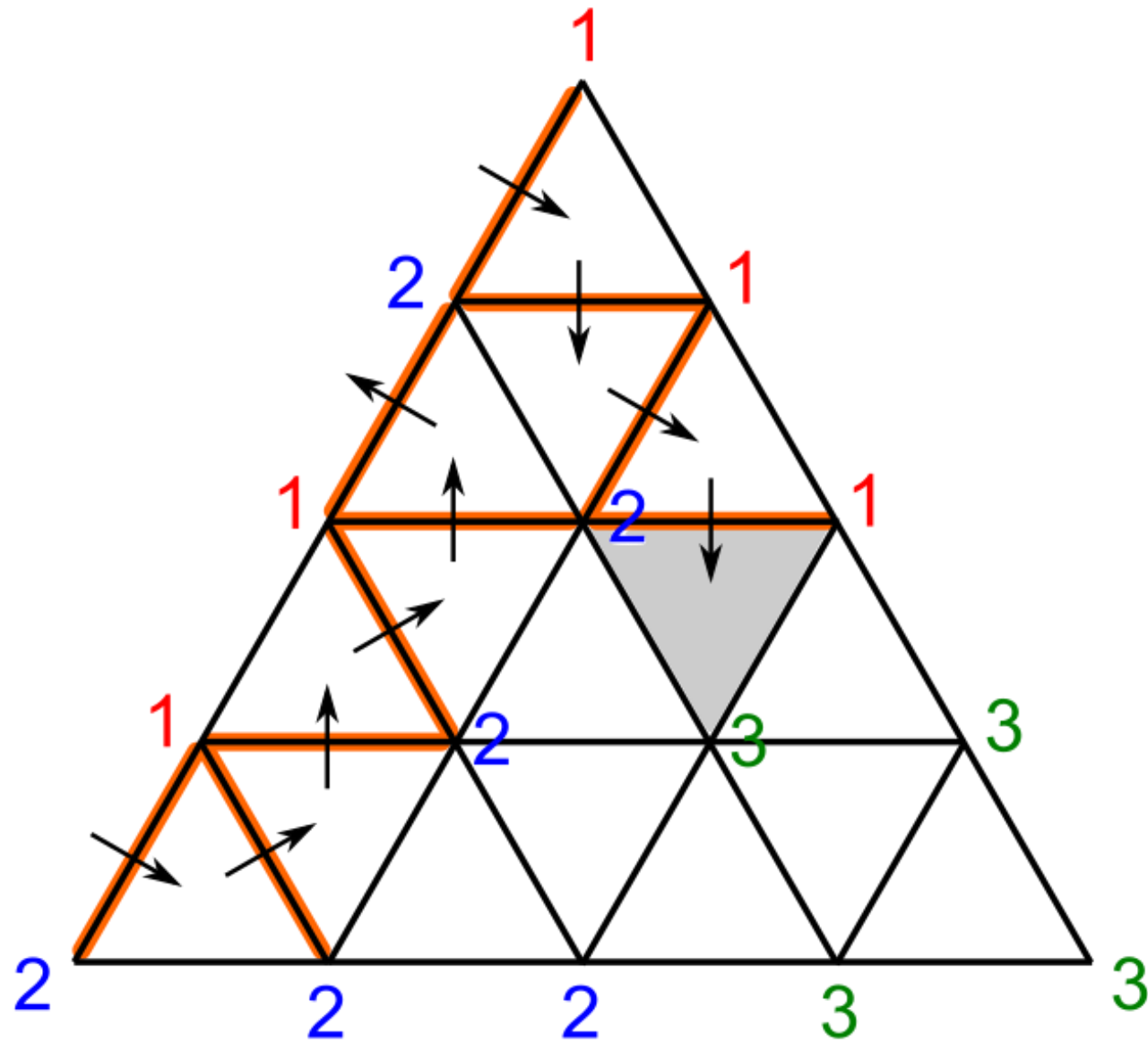

Call any 1—2 edge a "door".

Call any elementary triangle a "room".

Start walking!

- If thrown out, take another door.
- Some path must end up in a room with exactly one door.

Why can't such a walk cycle? Exercise.



Rental Harmony via Sperner's Lemma

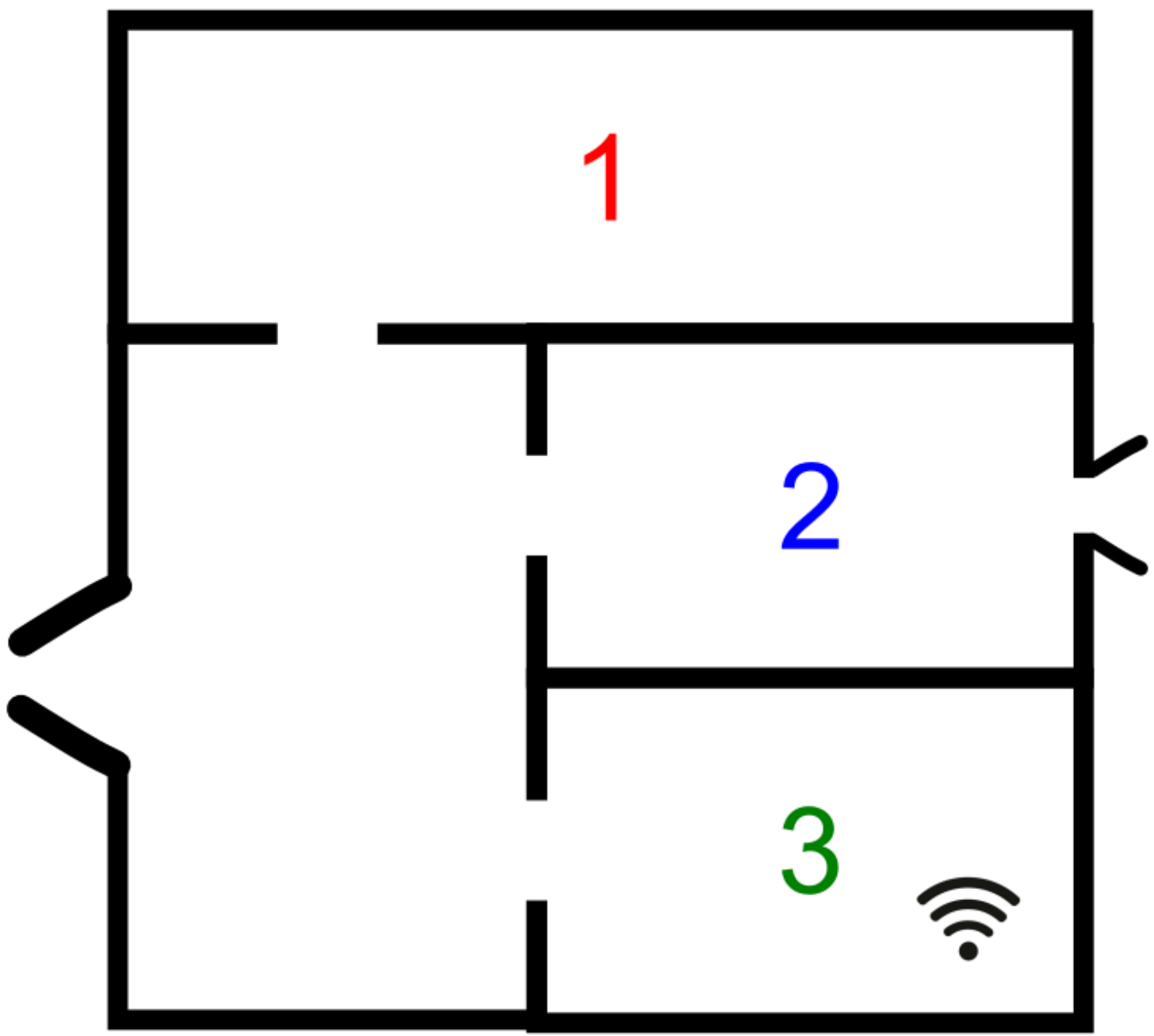

1

2

3

Rent
=
1000

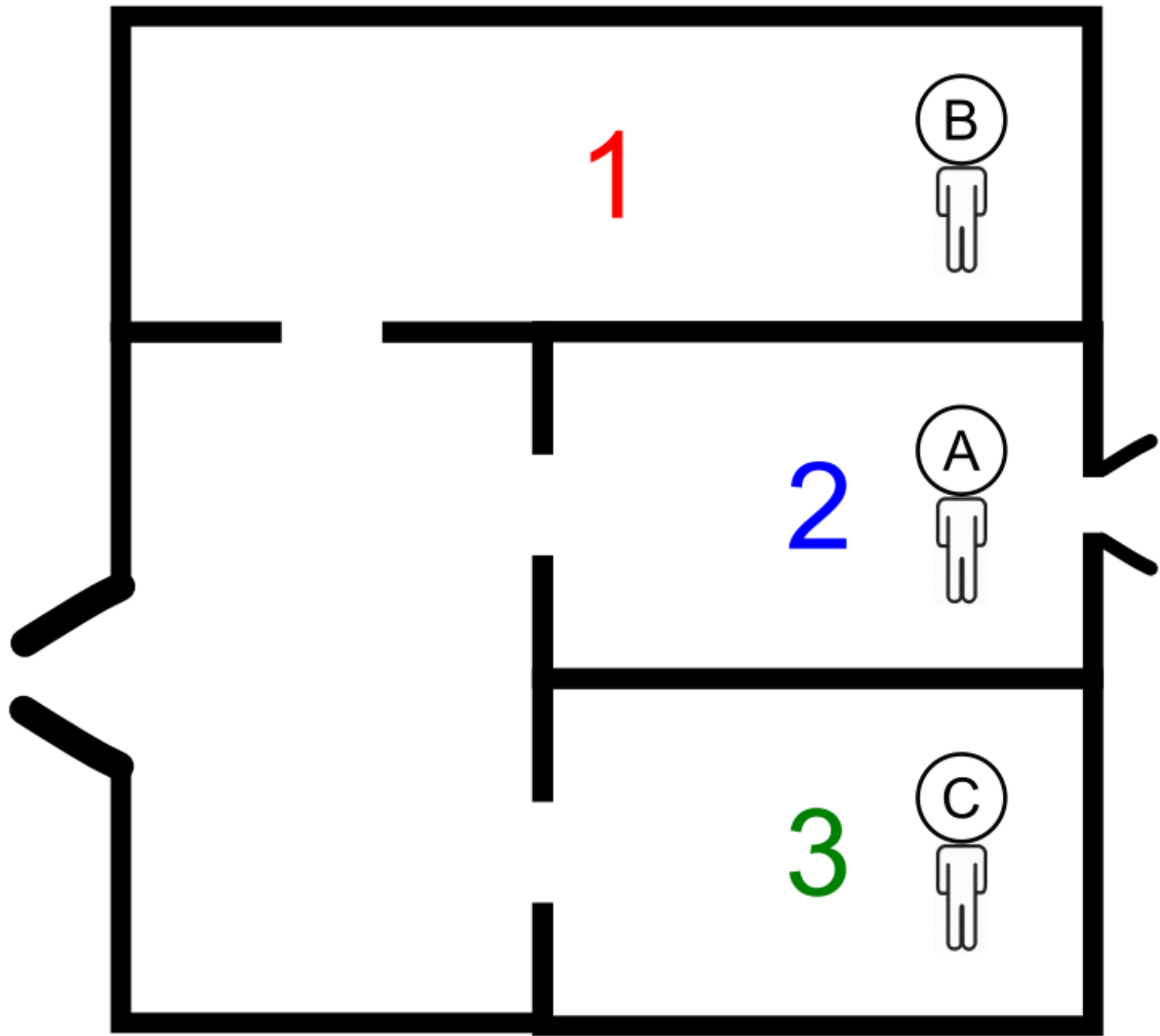

Rent
=
1000

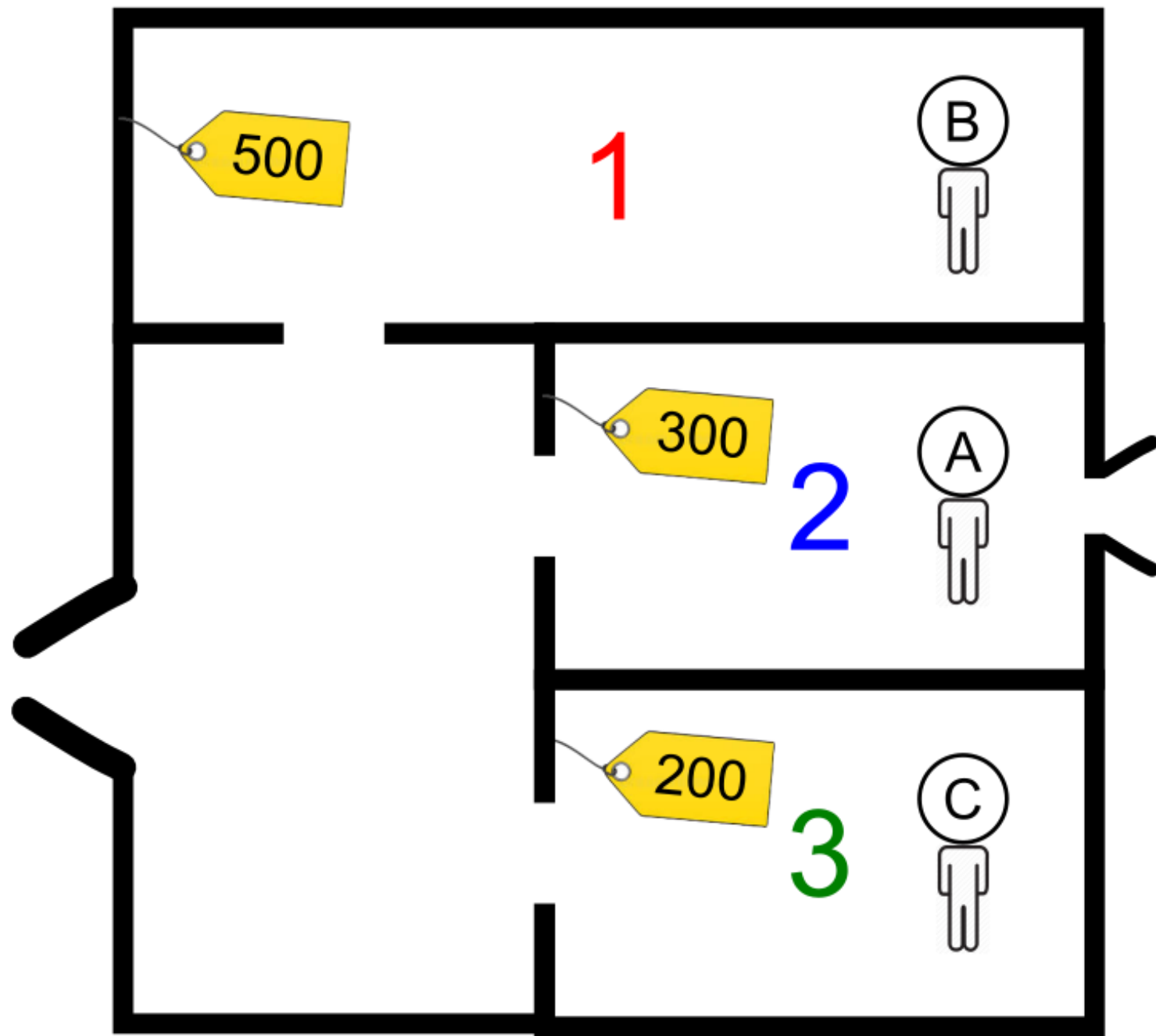

Rent
=
1000

Envy-free rent division

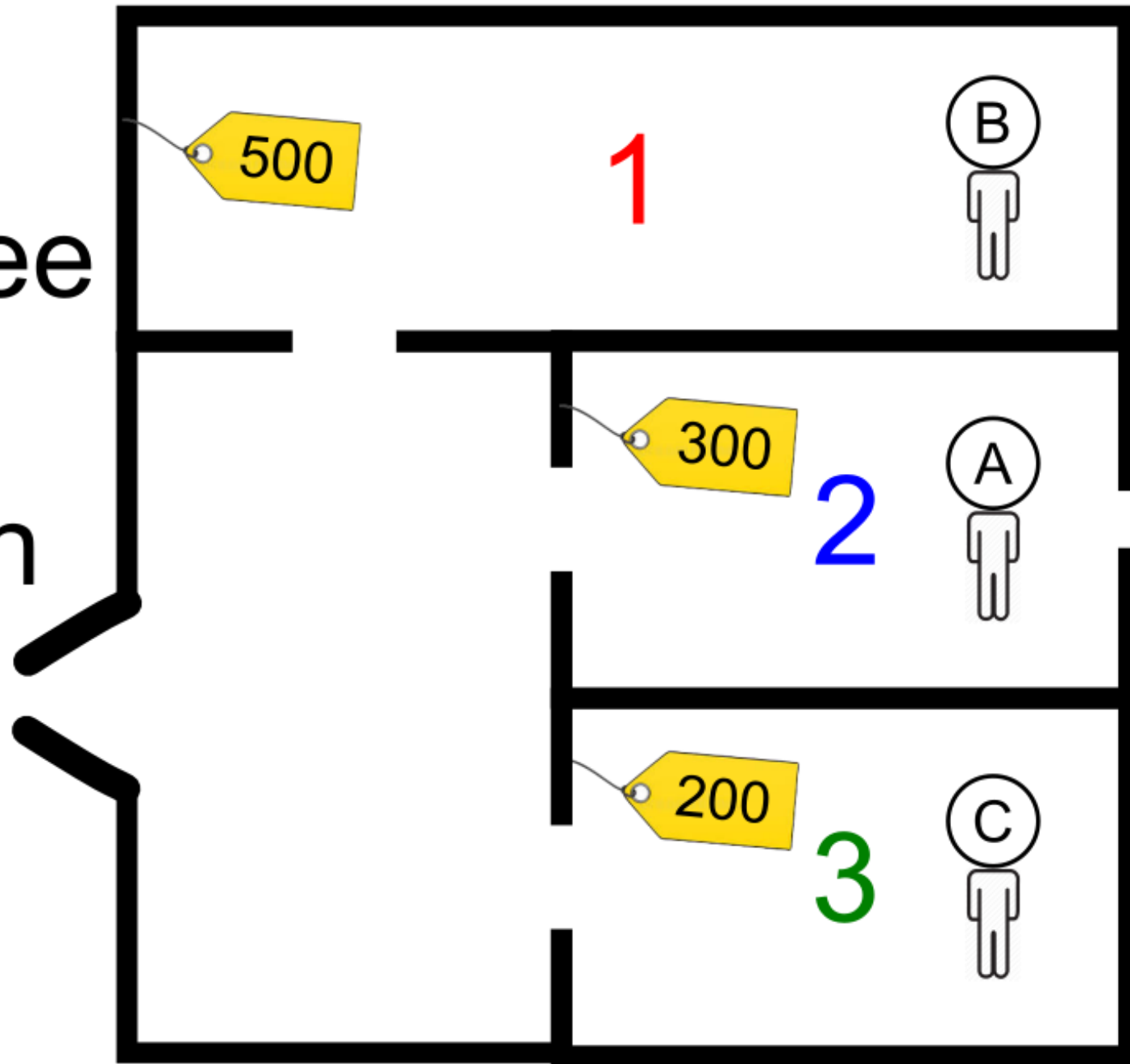

I like Room 1 for Rs. 500 over Room 2 for Rs. 300 and Room 3 for Rs. 200.

I like Room 2 for Rs. 300 over Room 1 for Rs. 500 and Room 3 for Rs. 200.

I like Room 3 for Rs. 200 over Room 1 for Rs. 500 and Room 2 for Rs. 200.

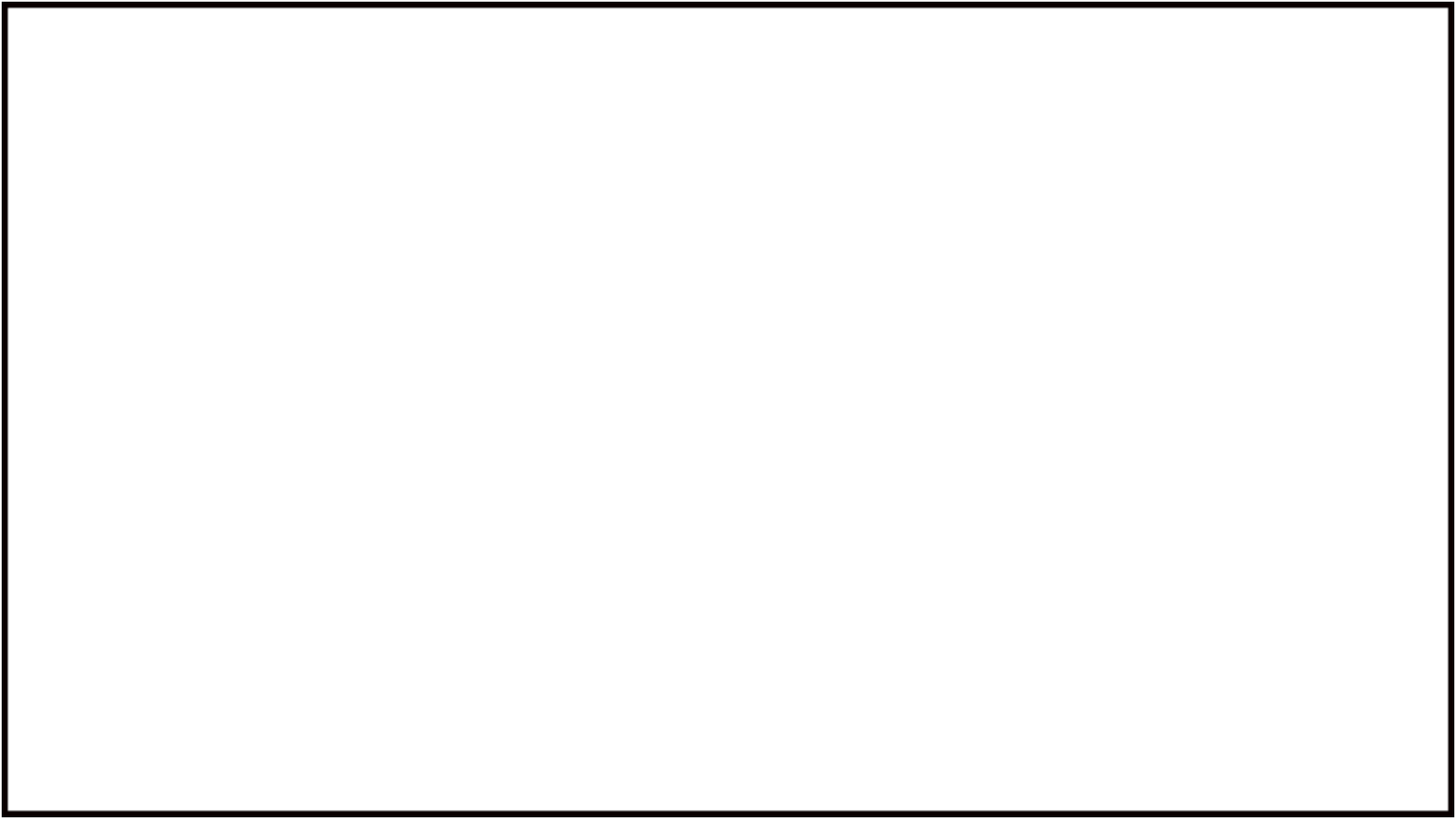

Ownership labeling

Preference labeling

Ownership labeling

Preference labeling

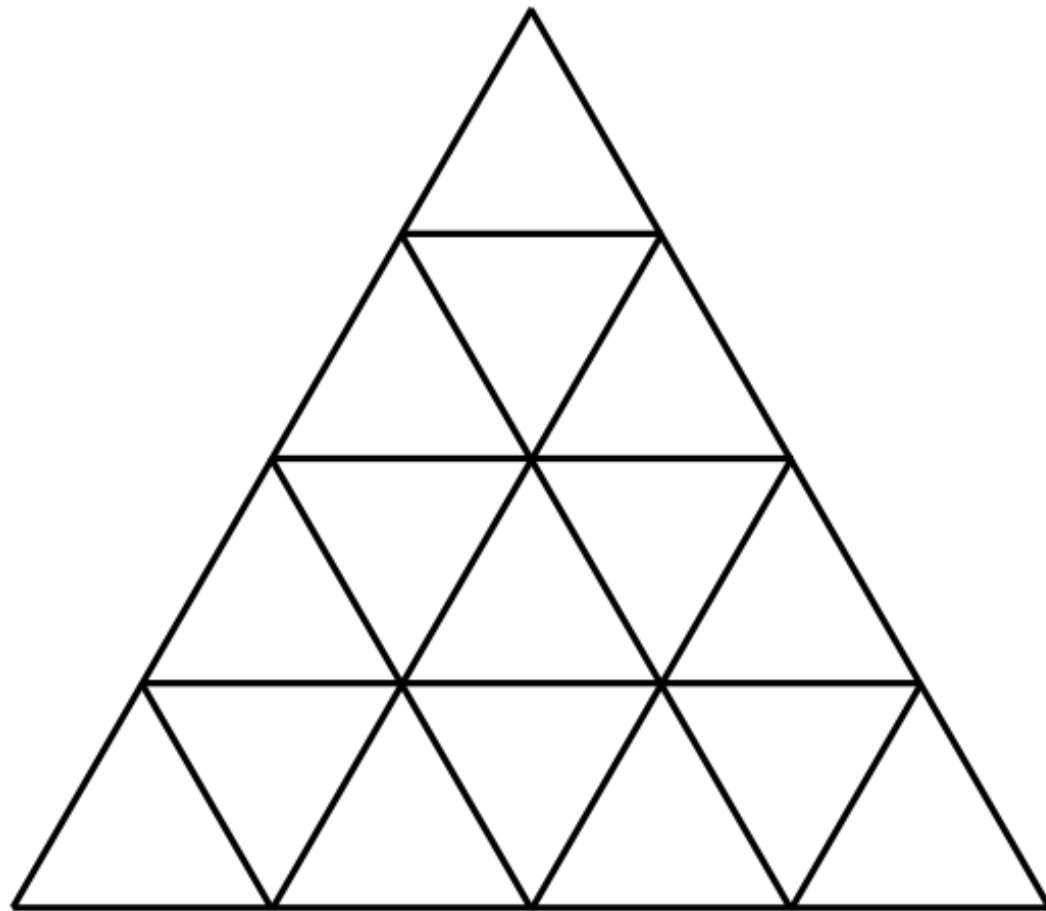

Ownership labeling

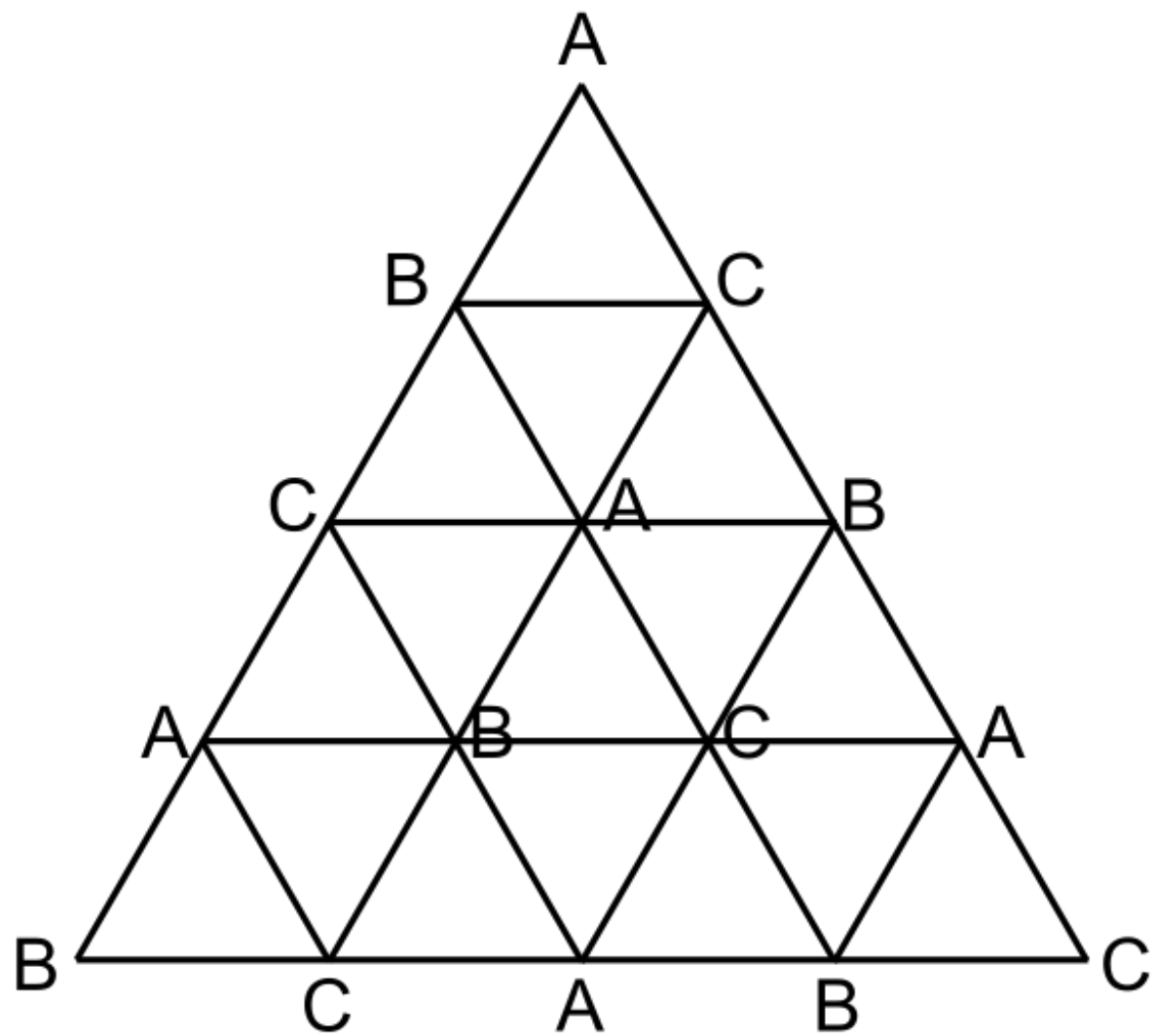

Preference labeling

Ownership labeling

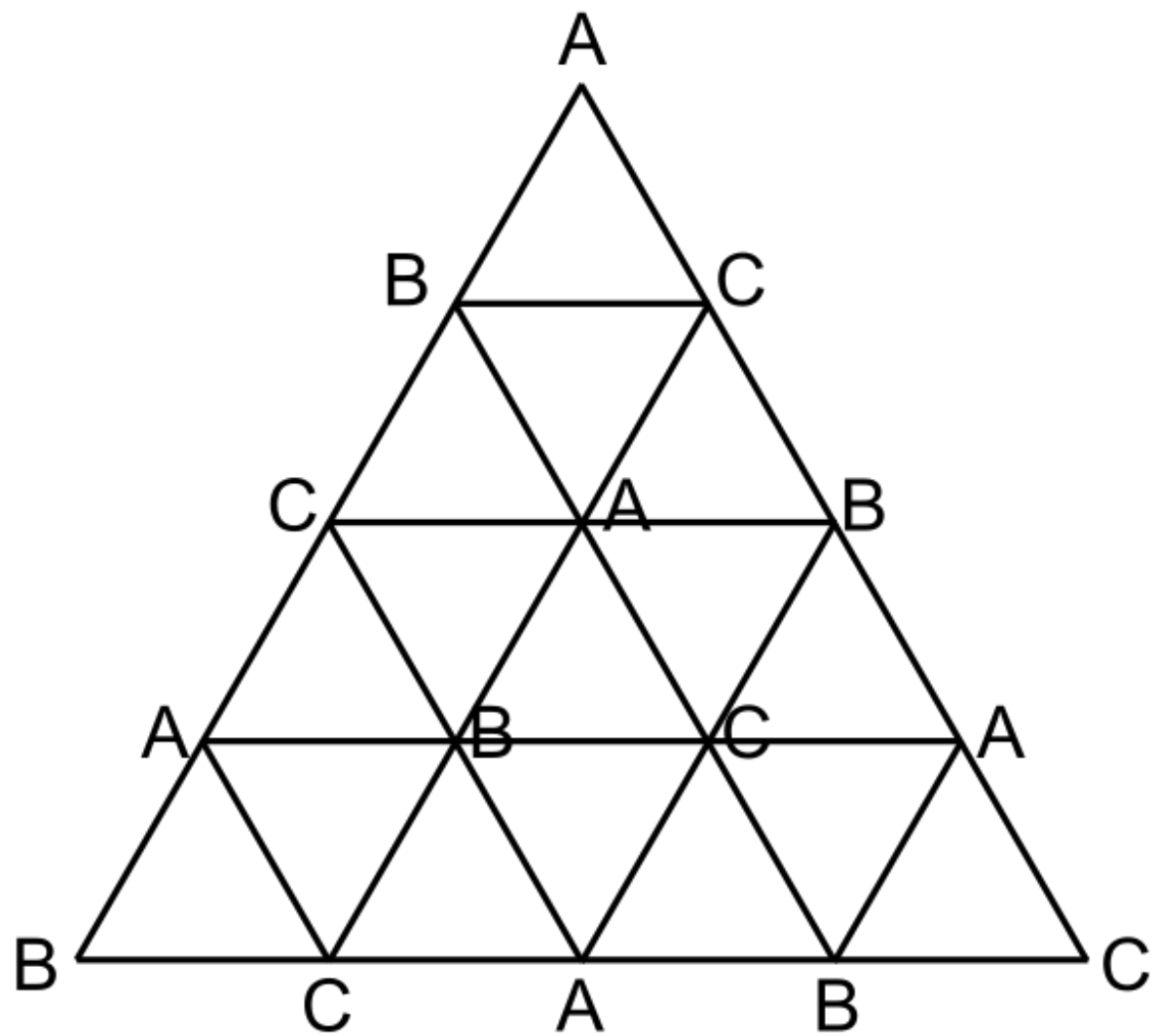

Preference labeling

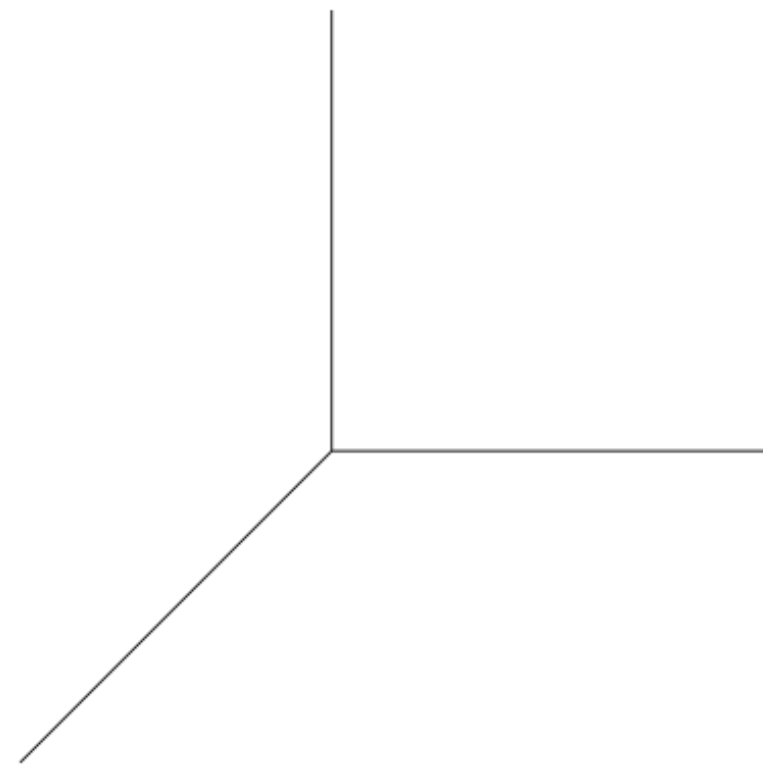

Ownership labeling

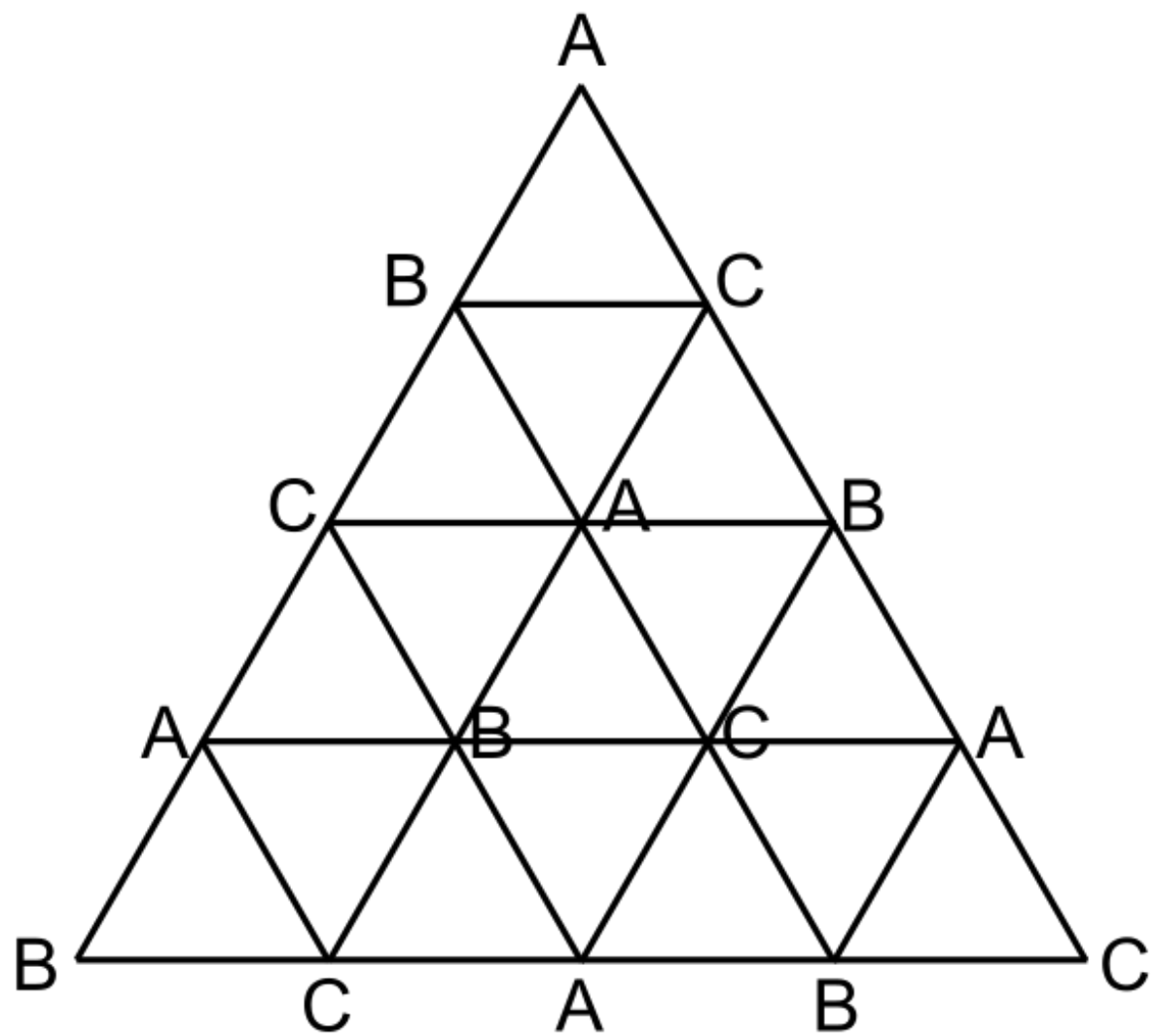

Preference labeling

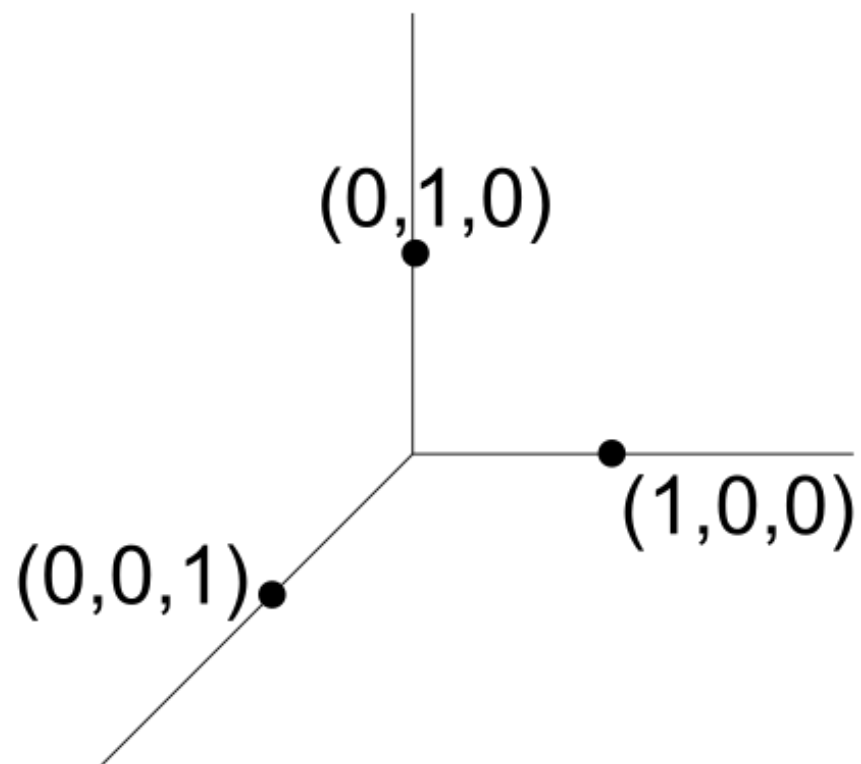

Ownership labeling

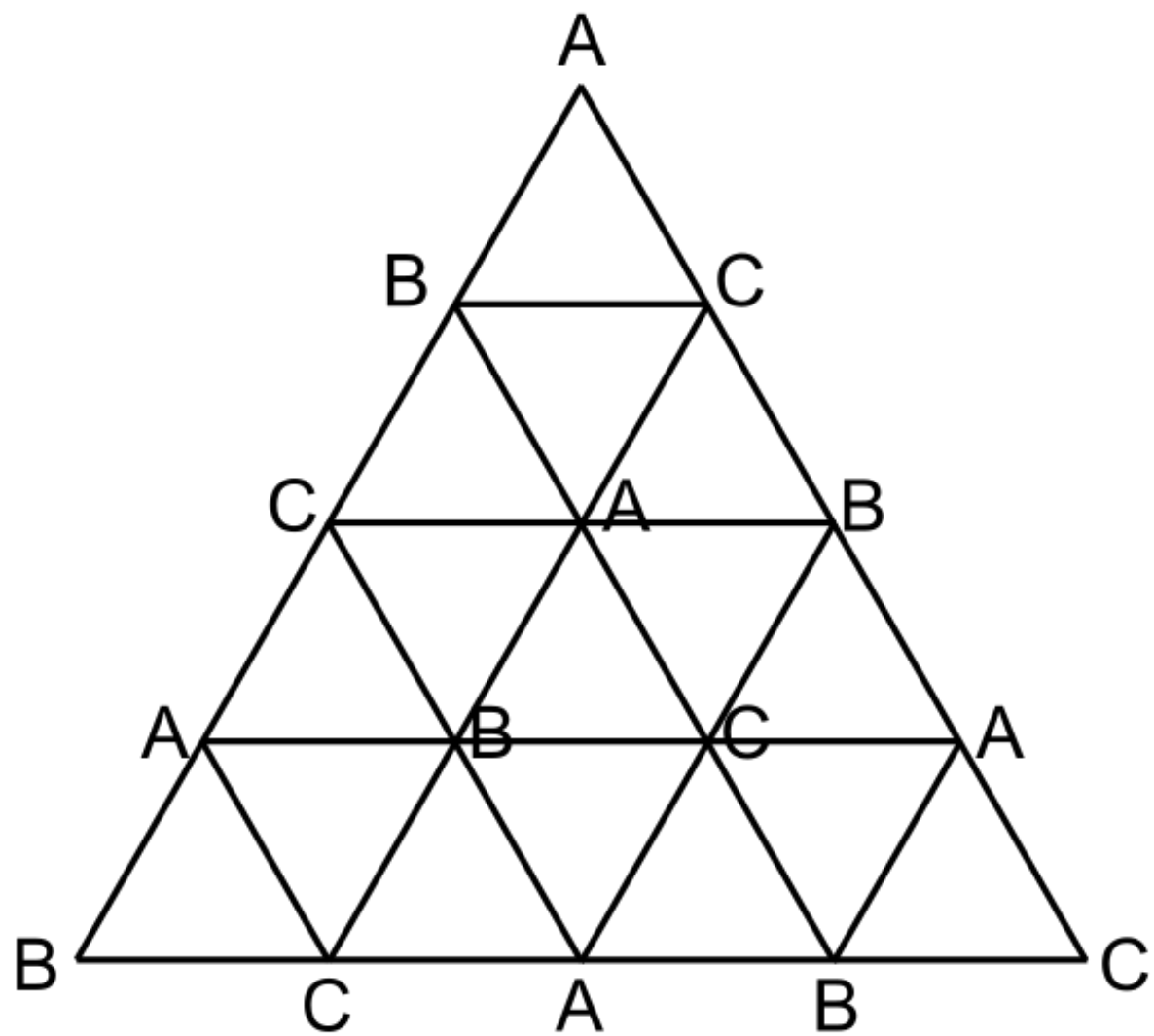

Preference labeling

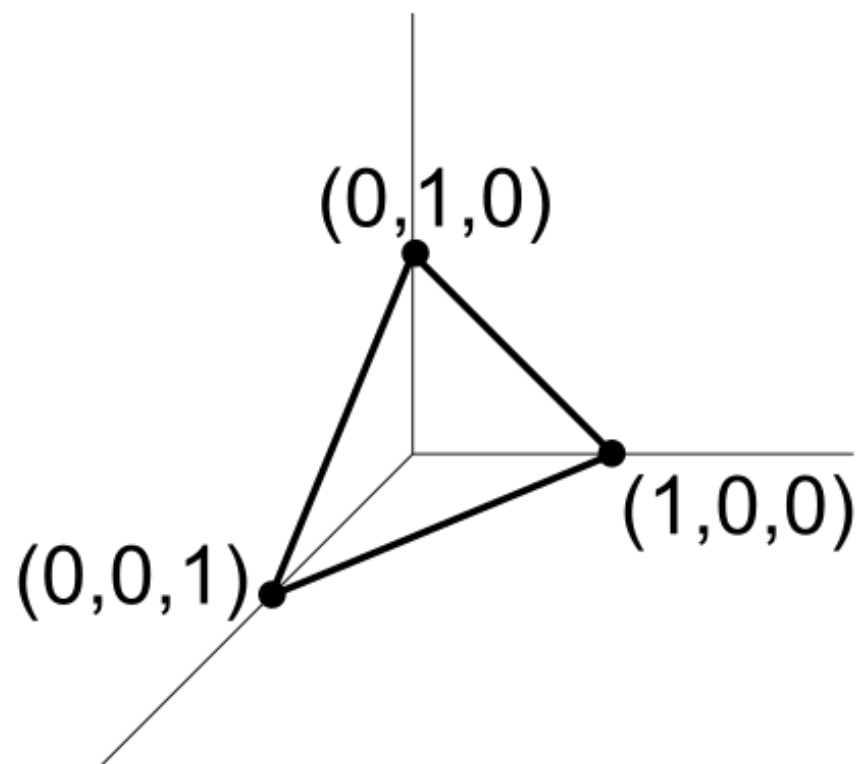

Ownership labeling

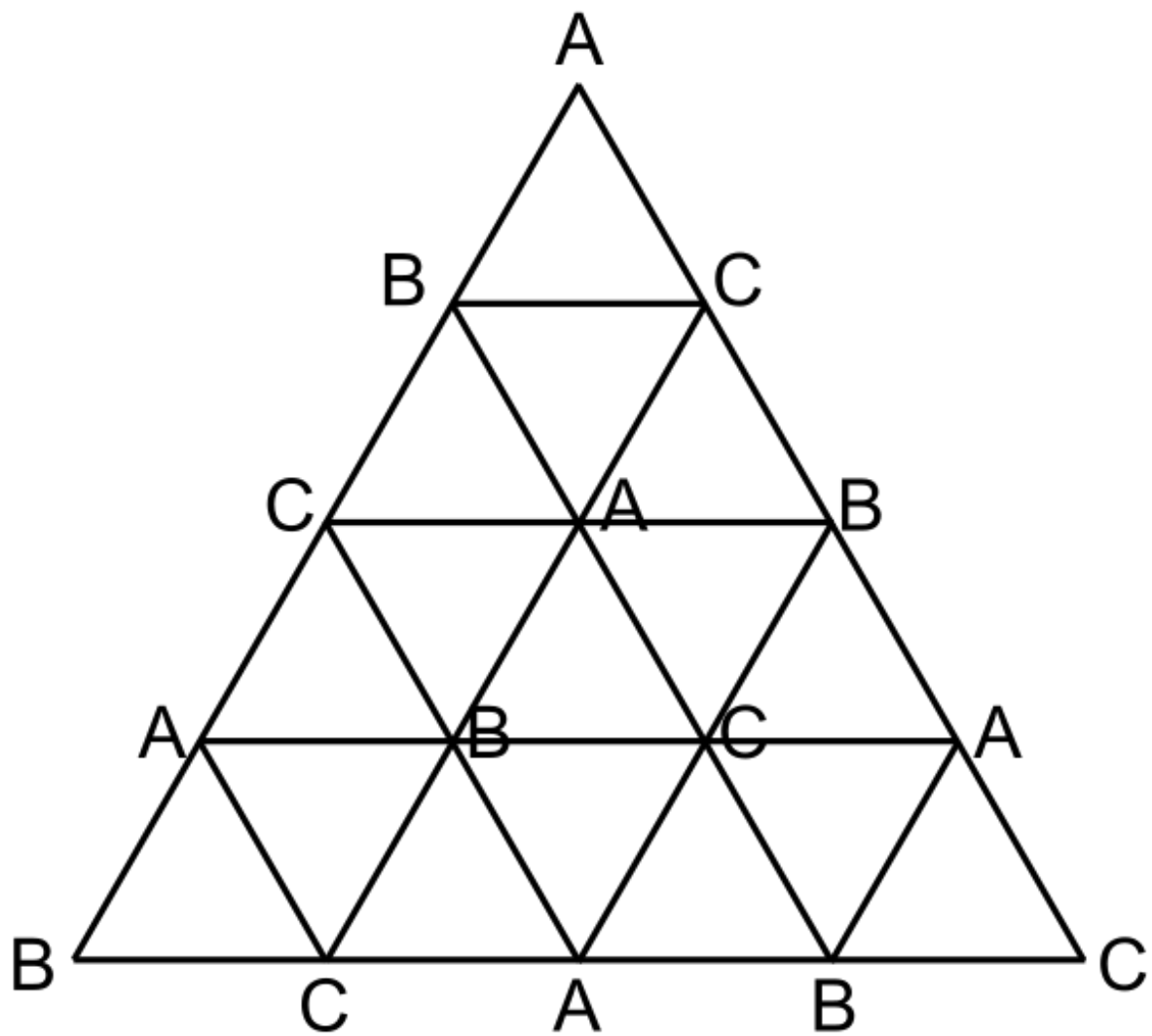

Preference labeling

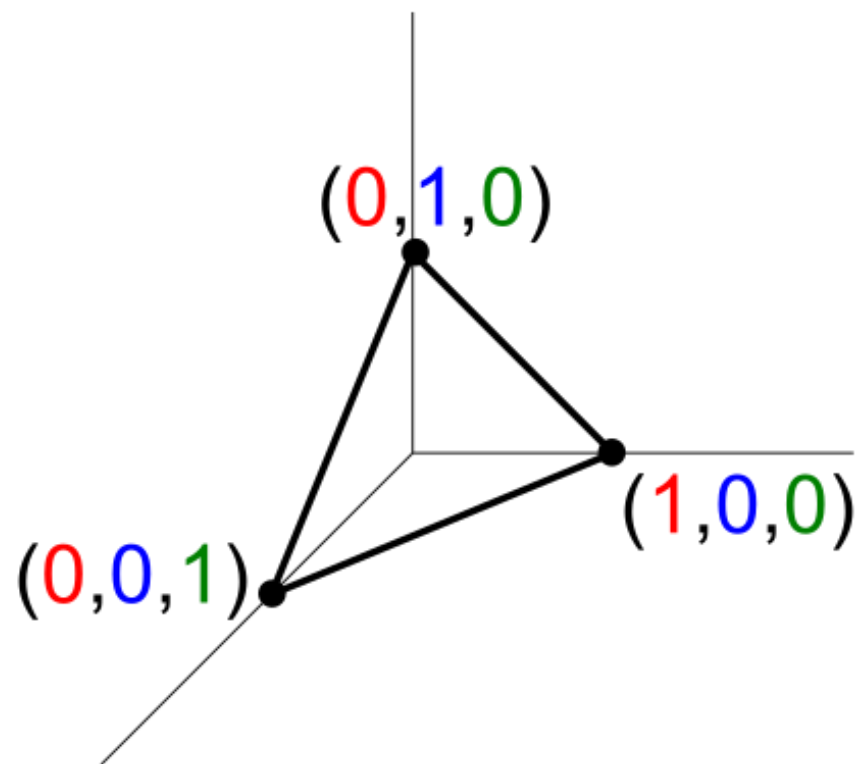

Ownership labeling

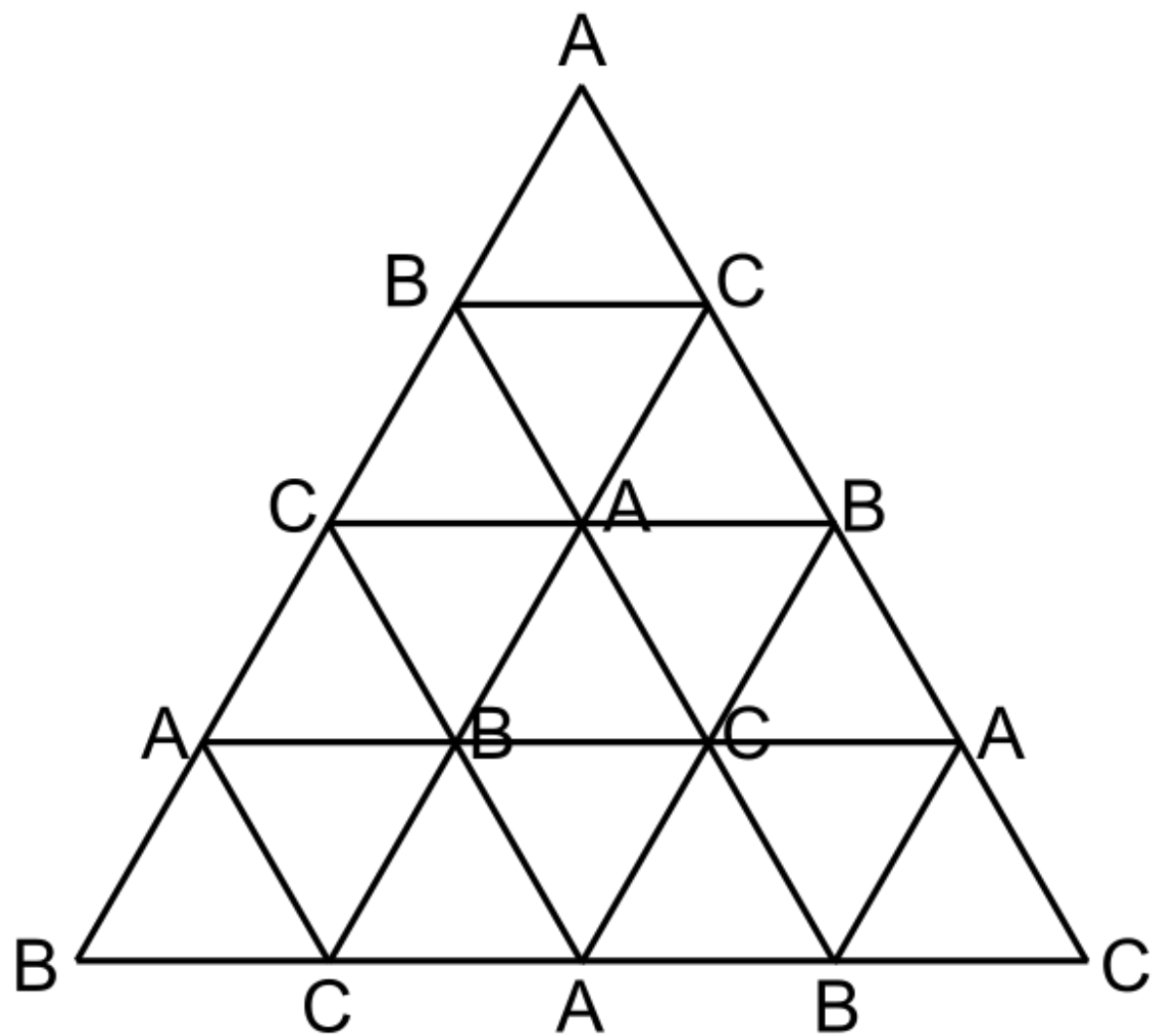

Preference labeling

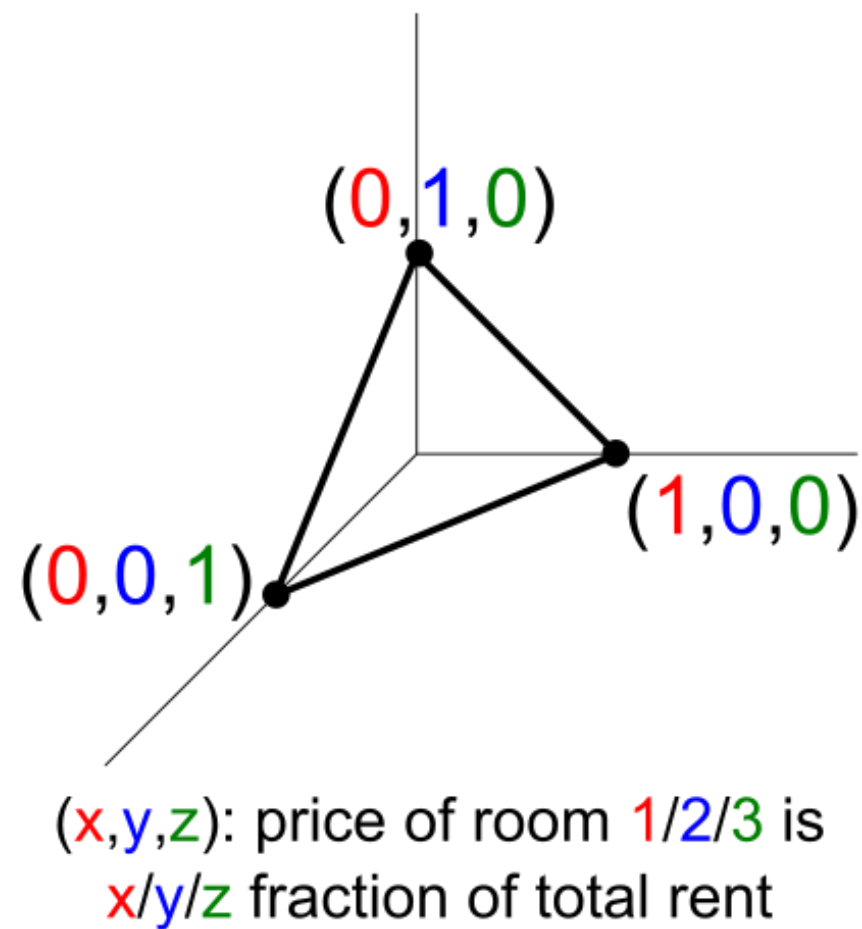

Ownership labeling

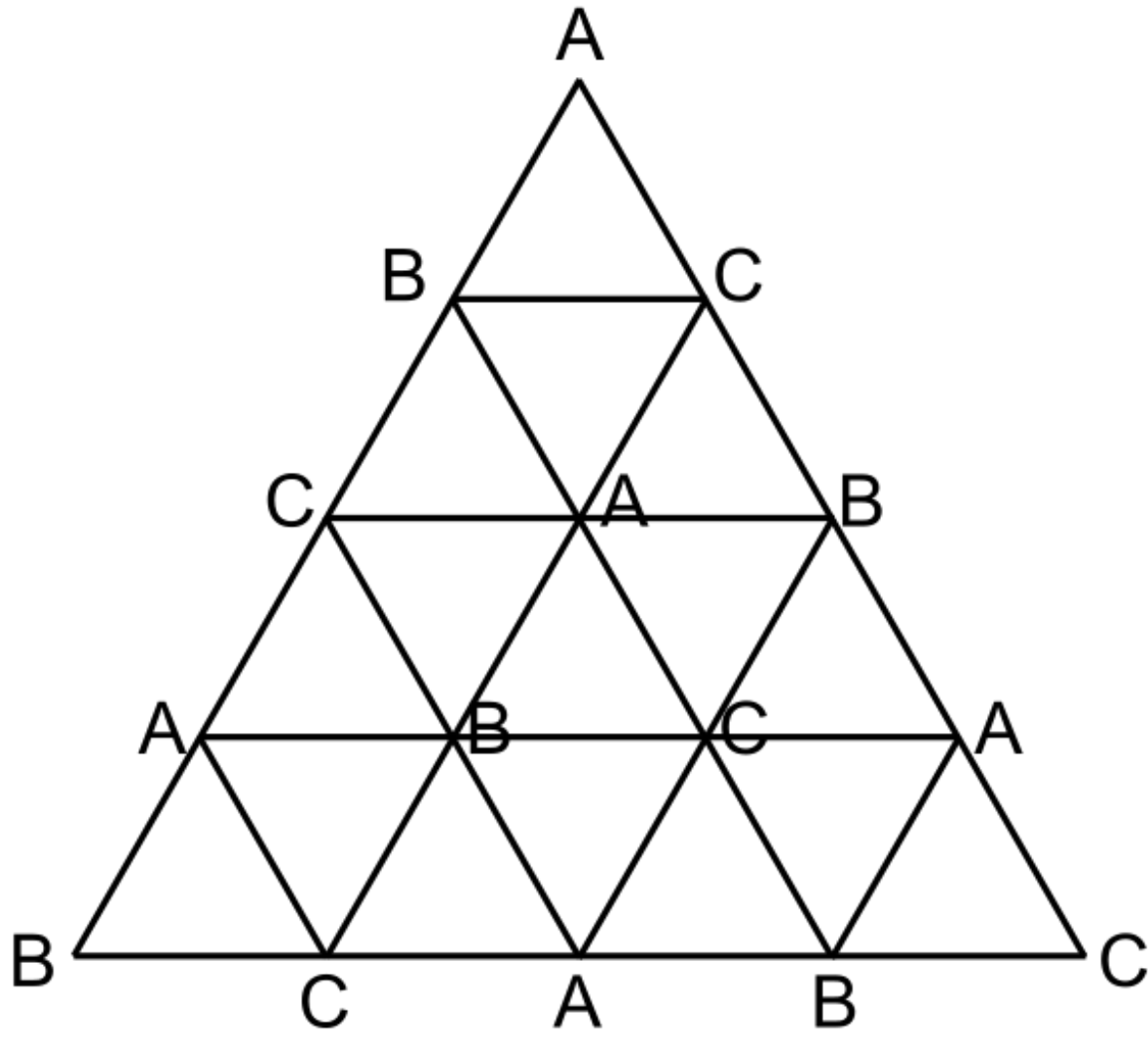

Preference labeling

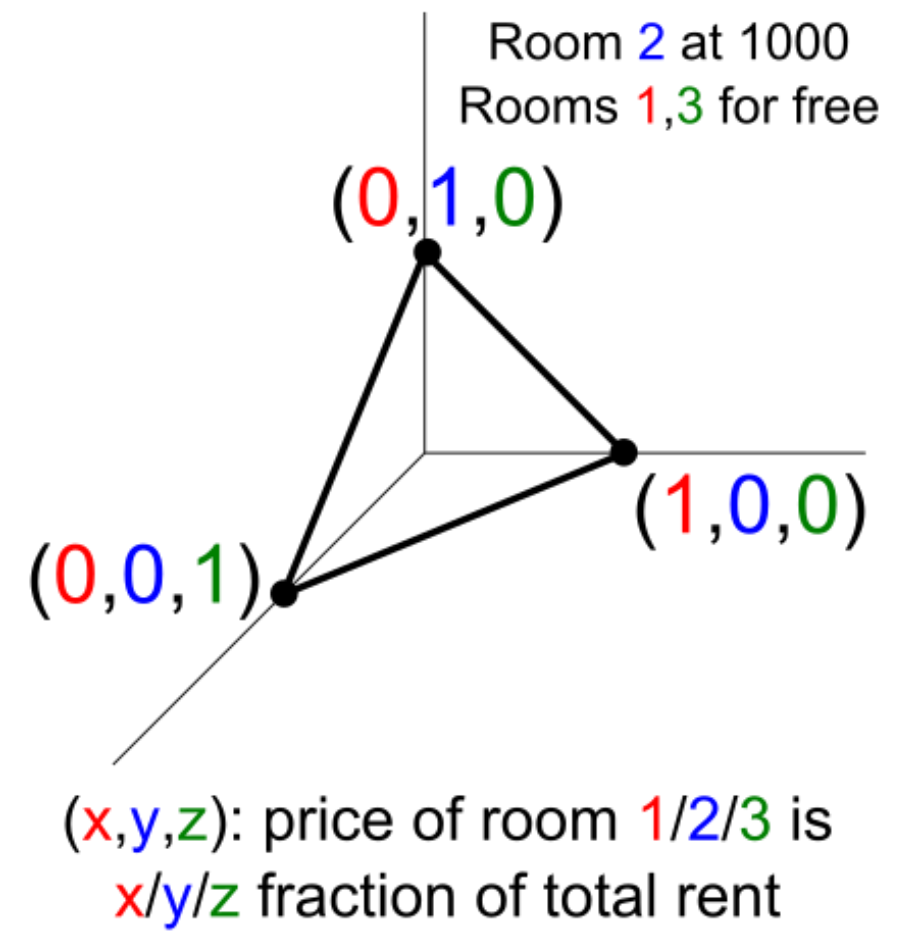

Ownership labeling

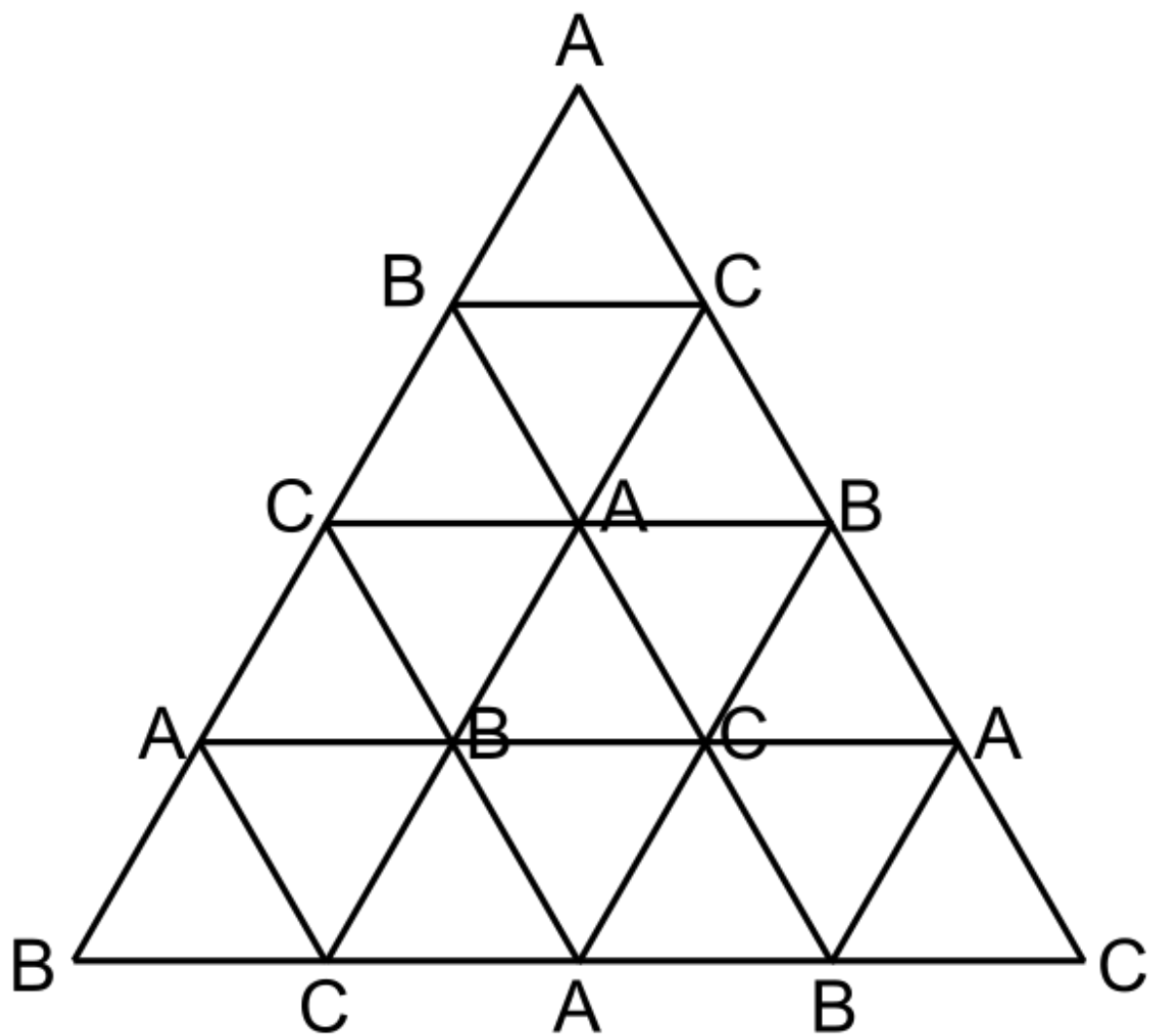

Preference labeling

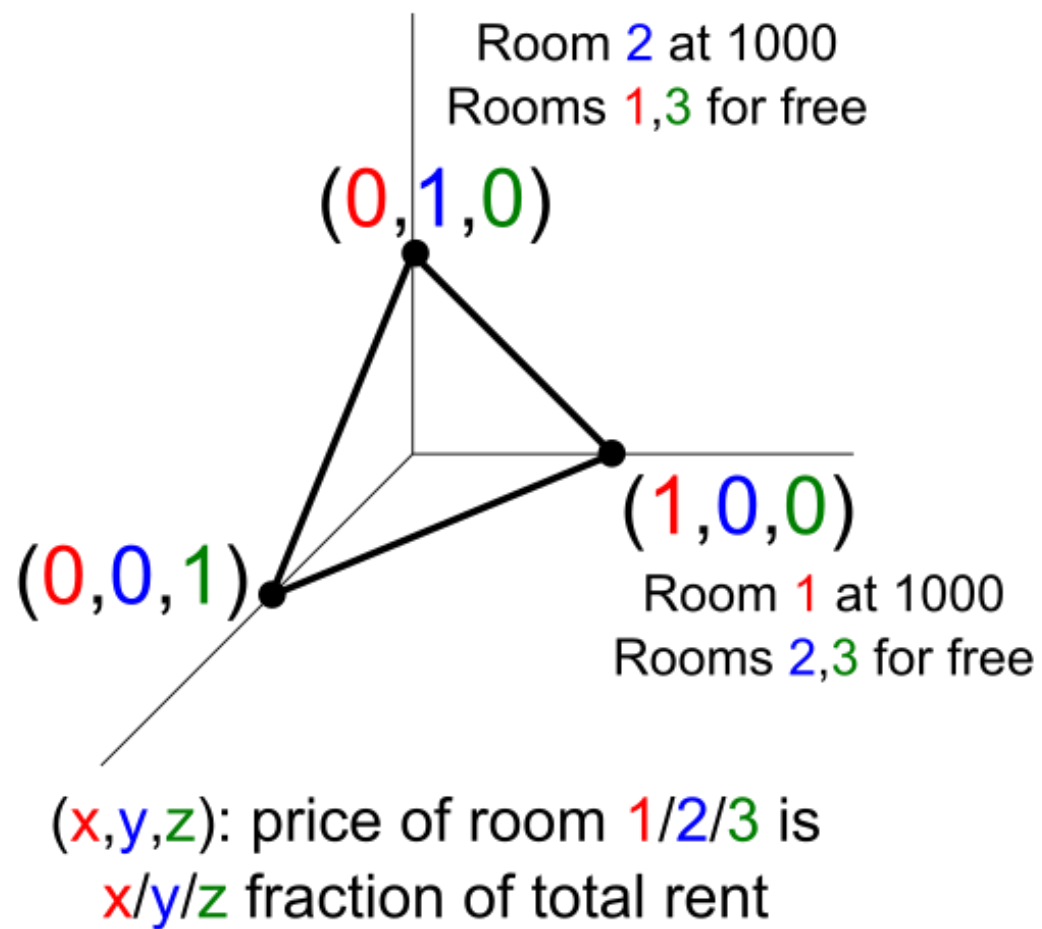

Ownership labeling

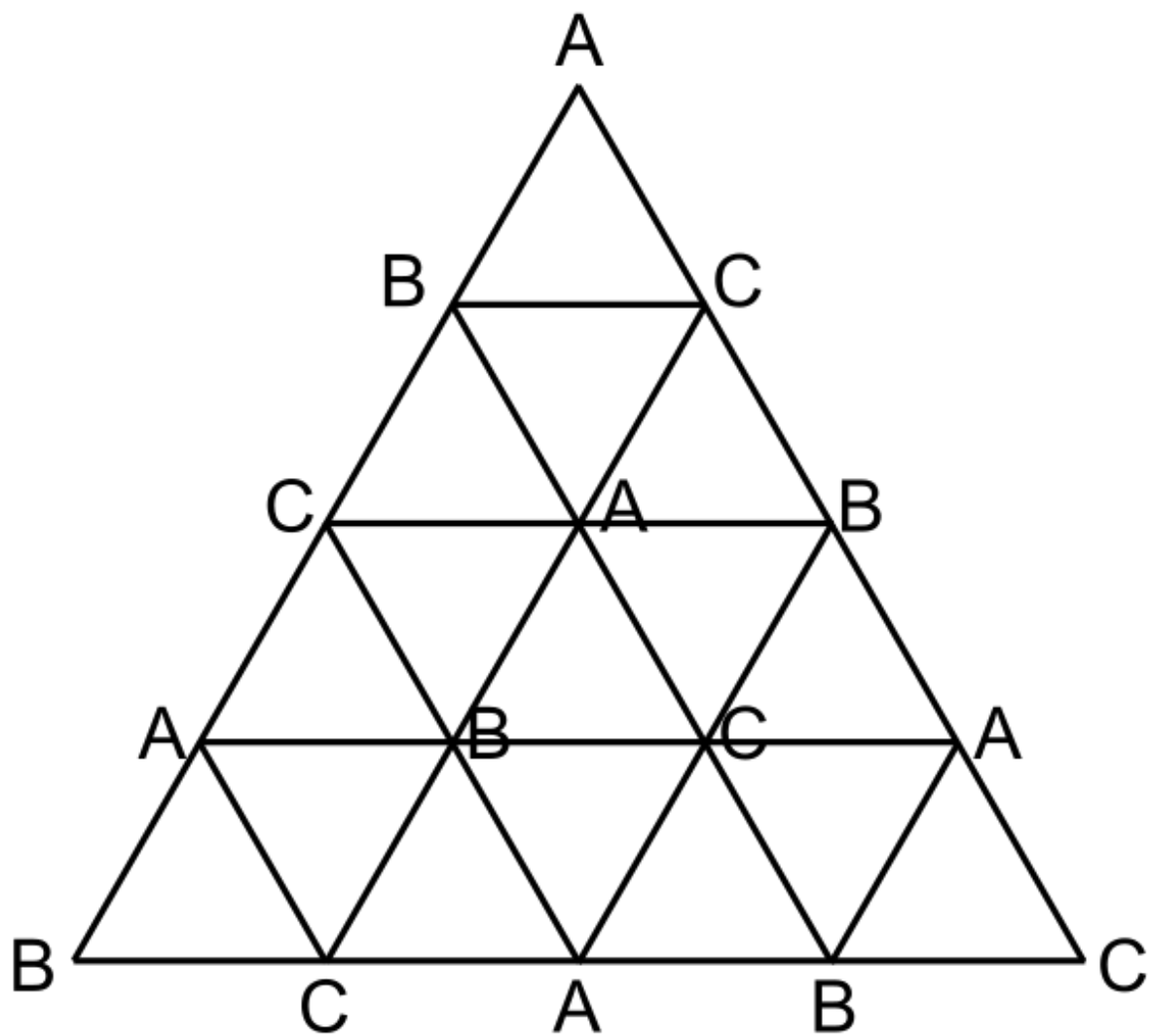

Preference labeling

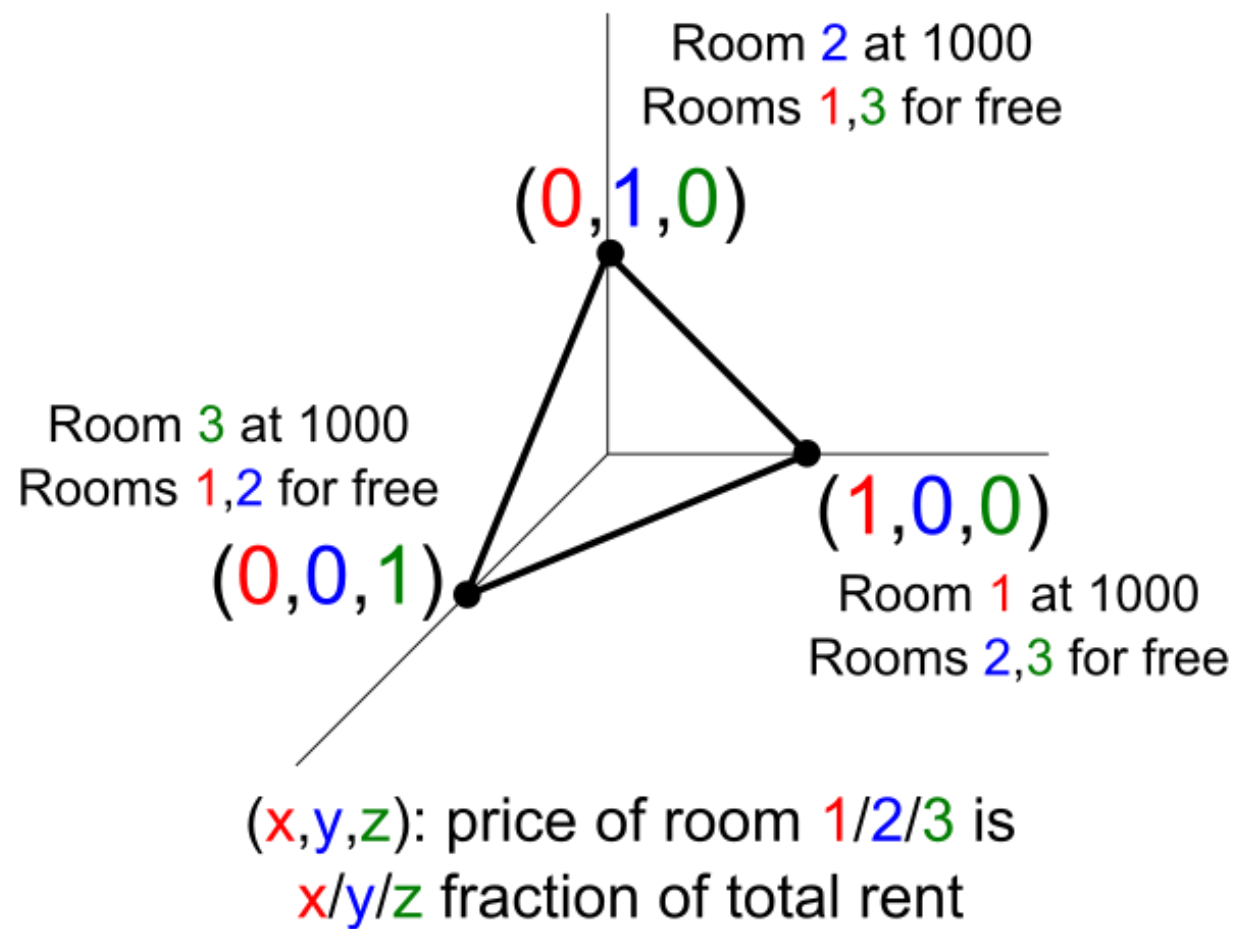

Ownership labeling

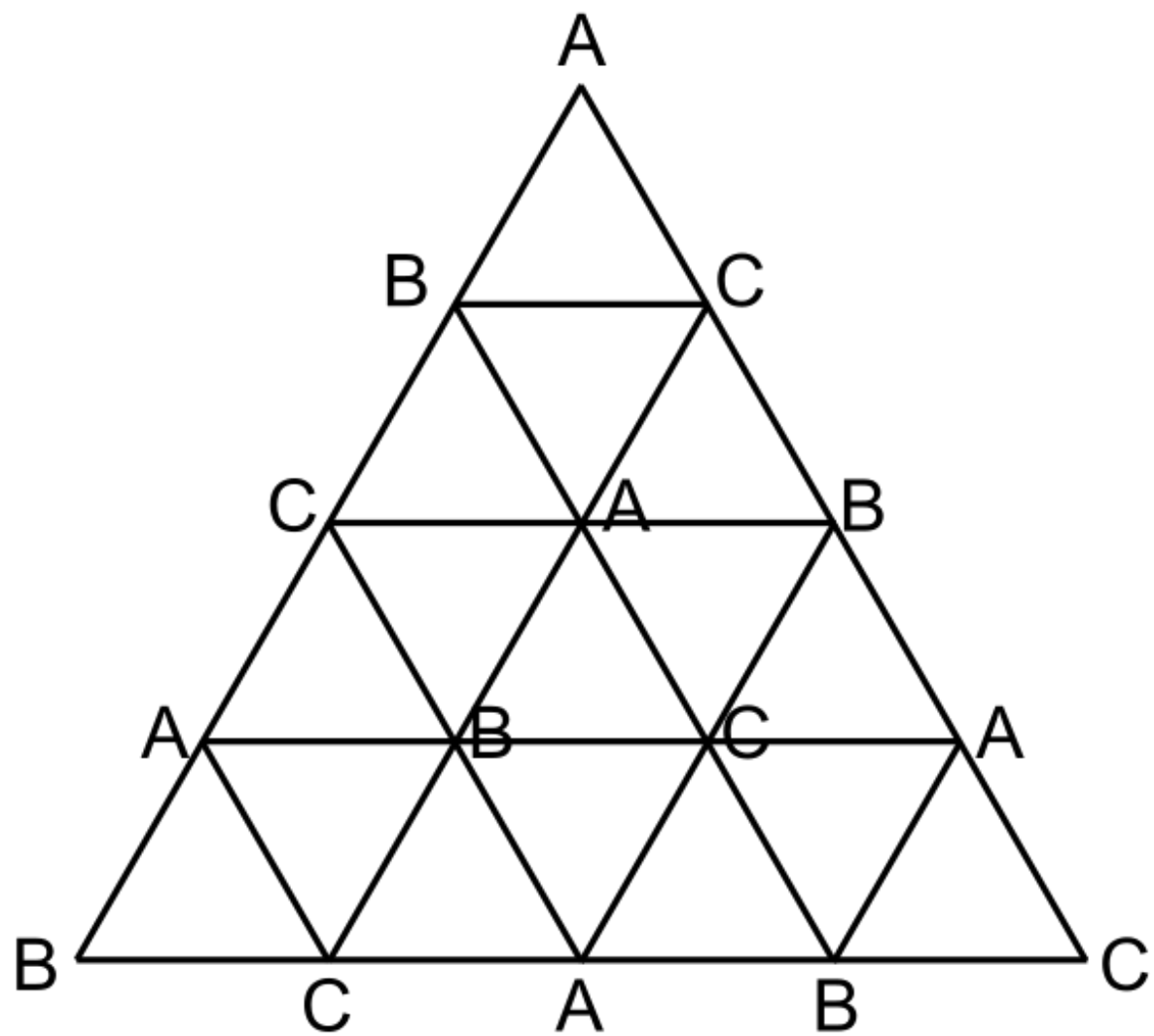

Preference labeling

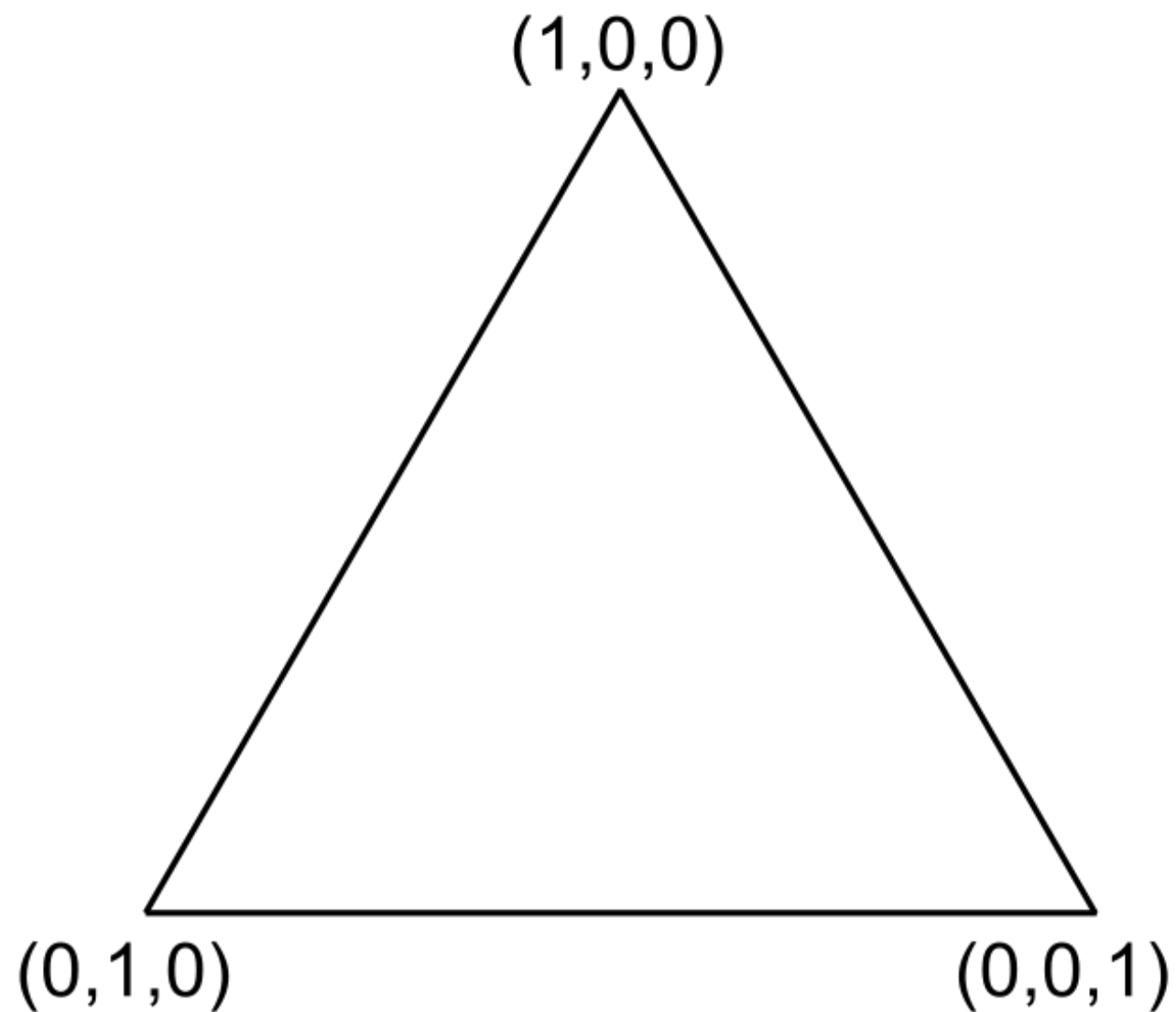

Ownership labeling

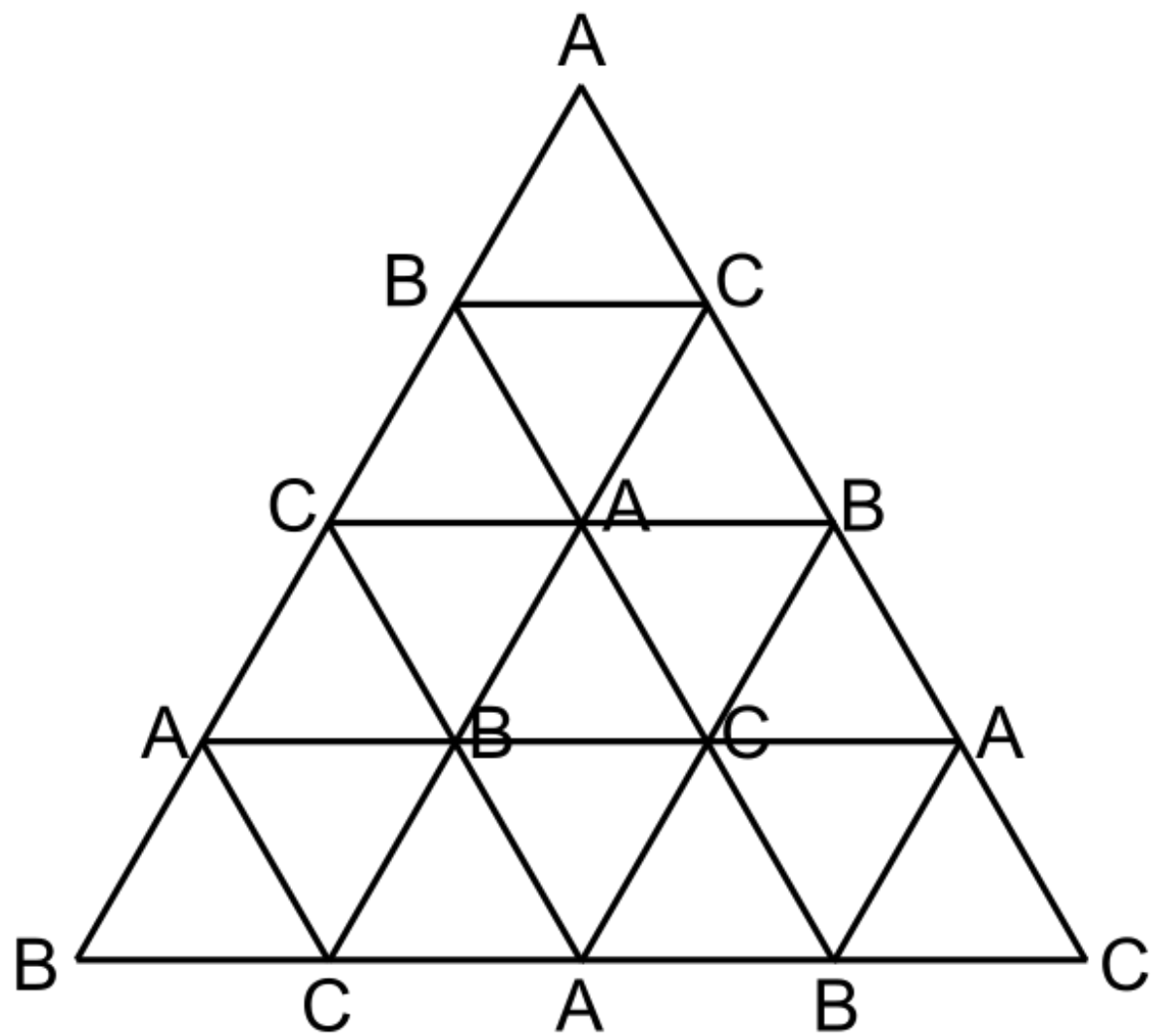

Preference labeling

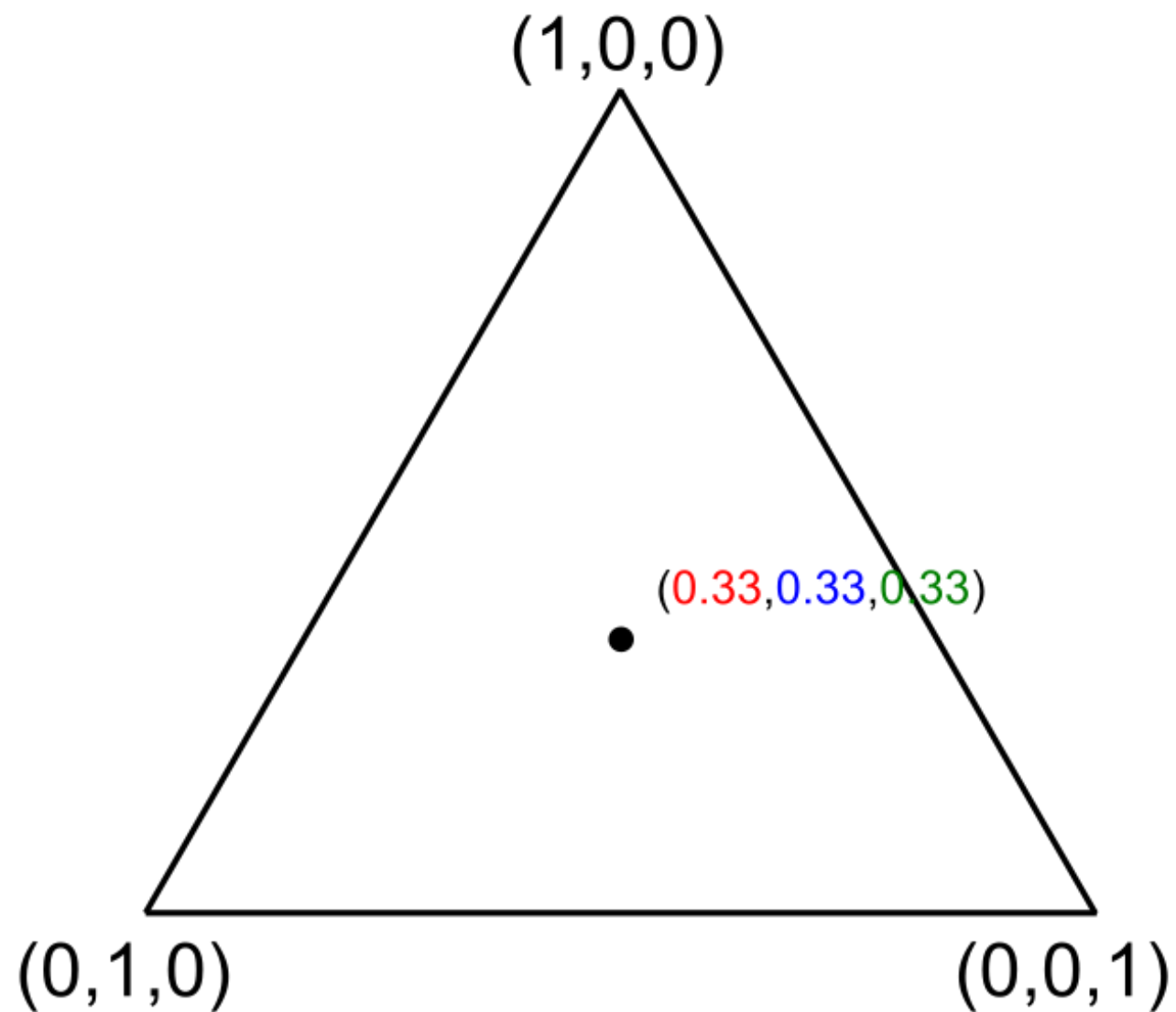

Ownership labeling

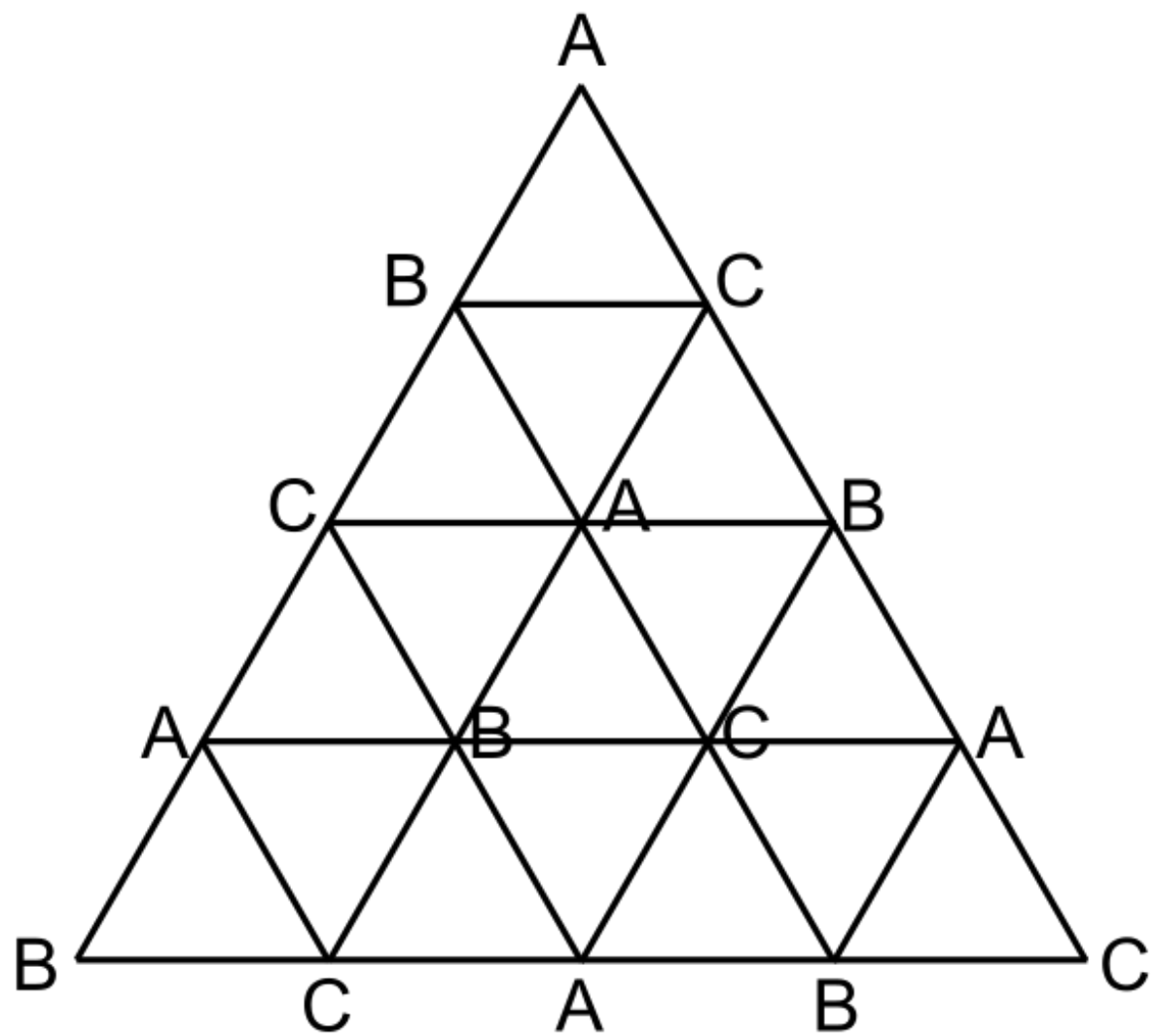

Preference labeling

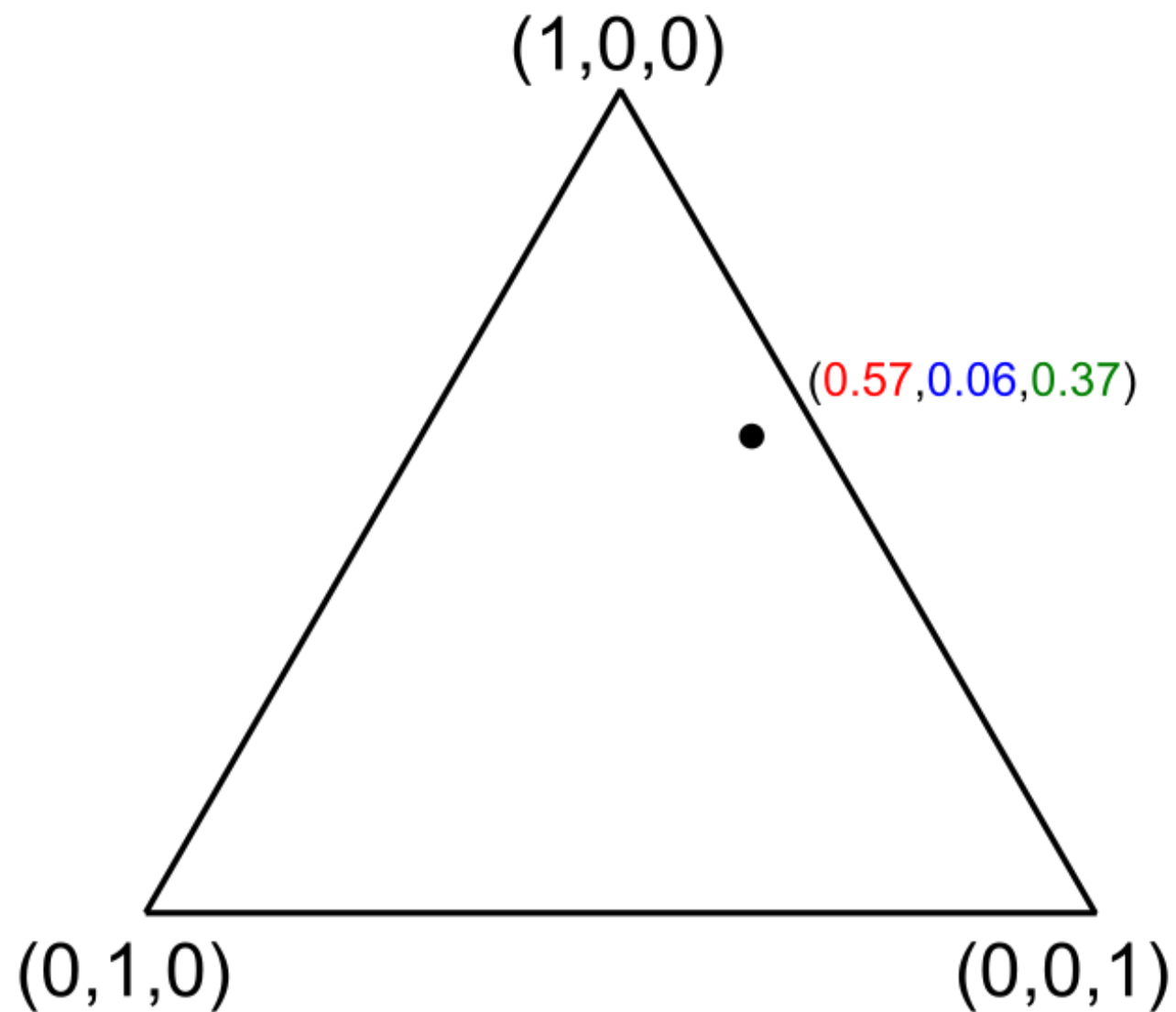

Ownership labeling

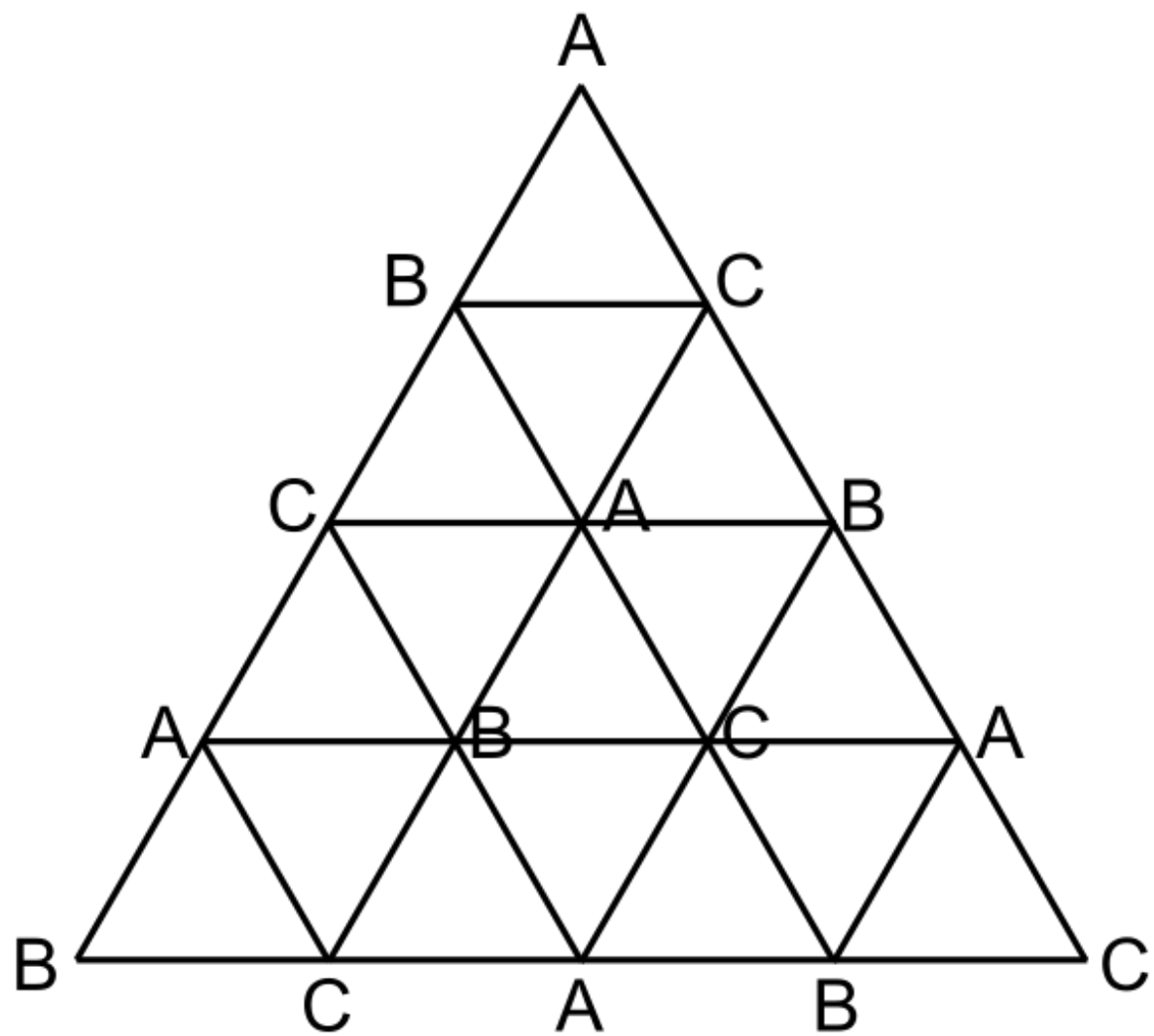

Preference labeling

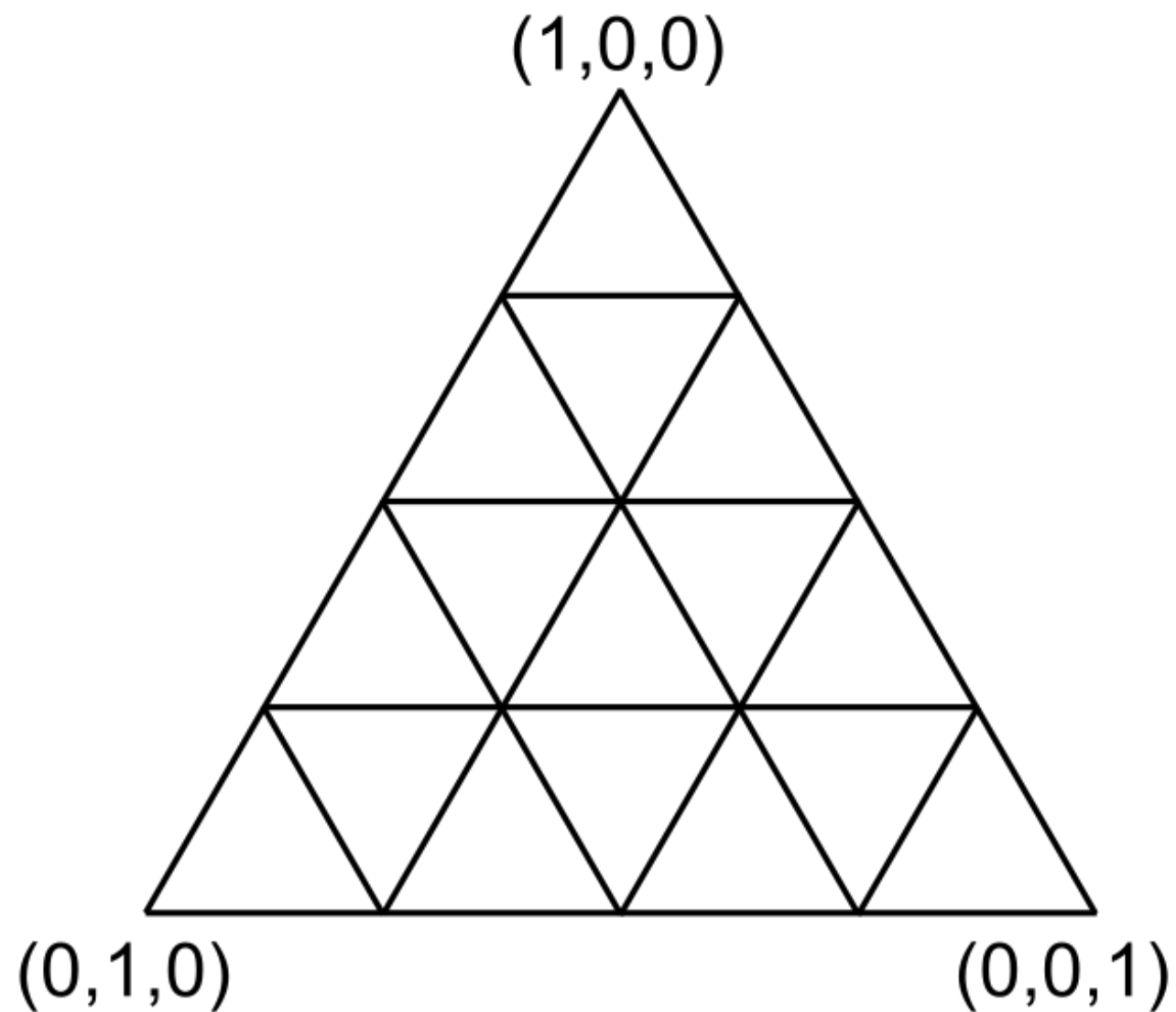

For each vertex in the ownership triangle, ask the owner its favorite room at the pricing given in the preference triangle.

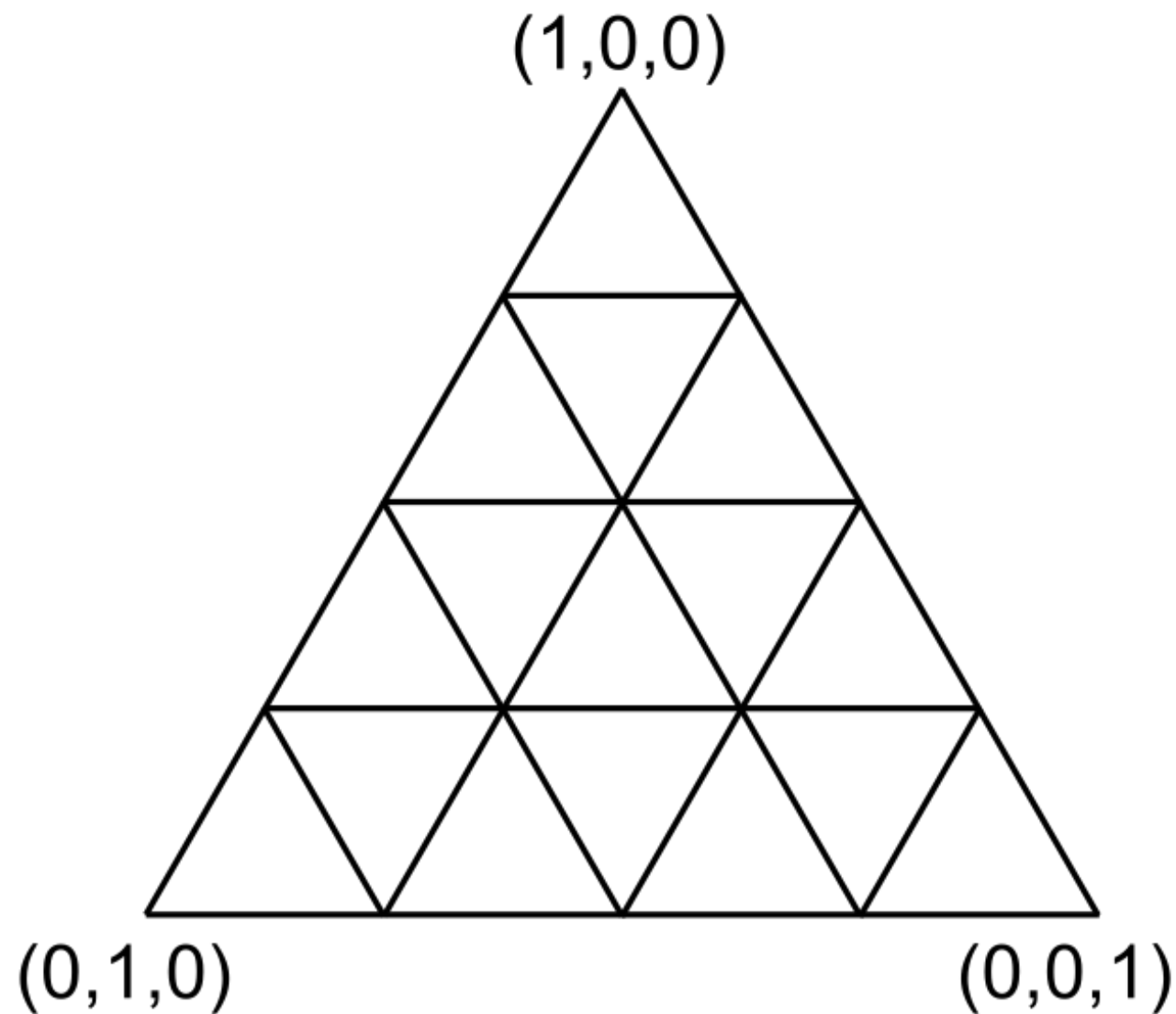
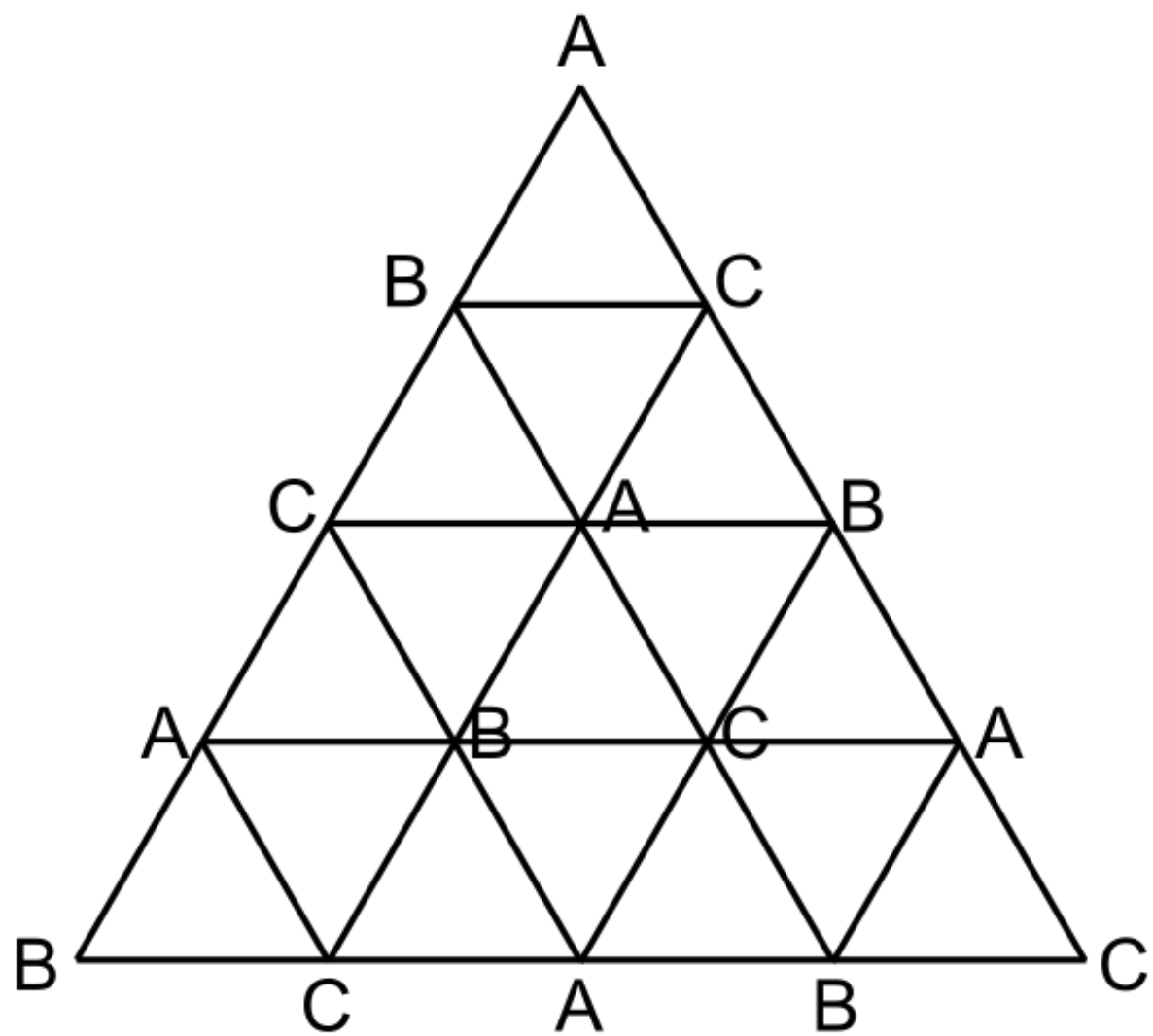

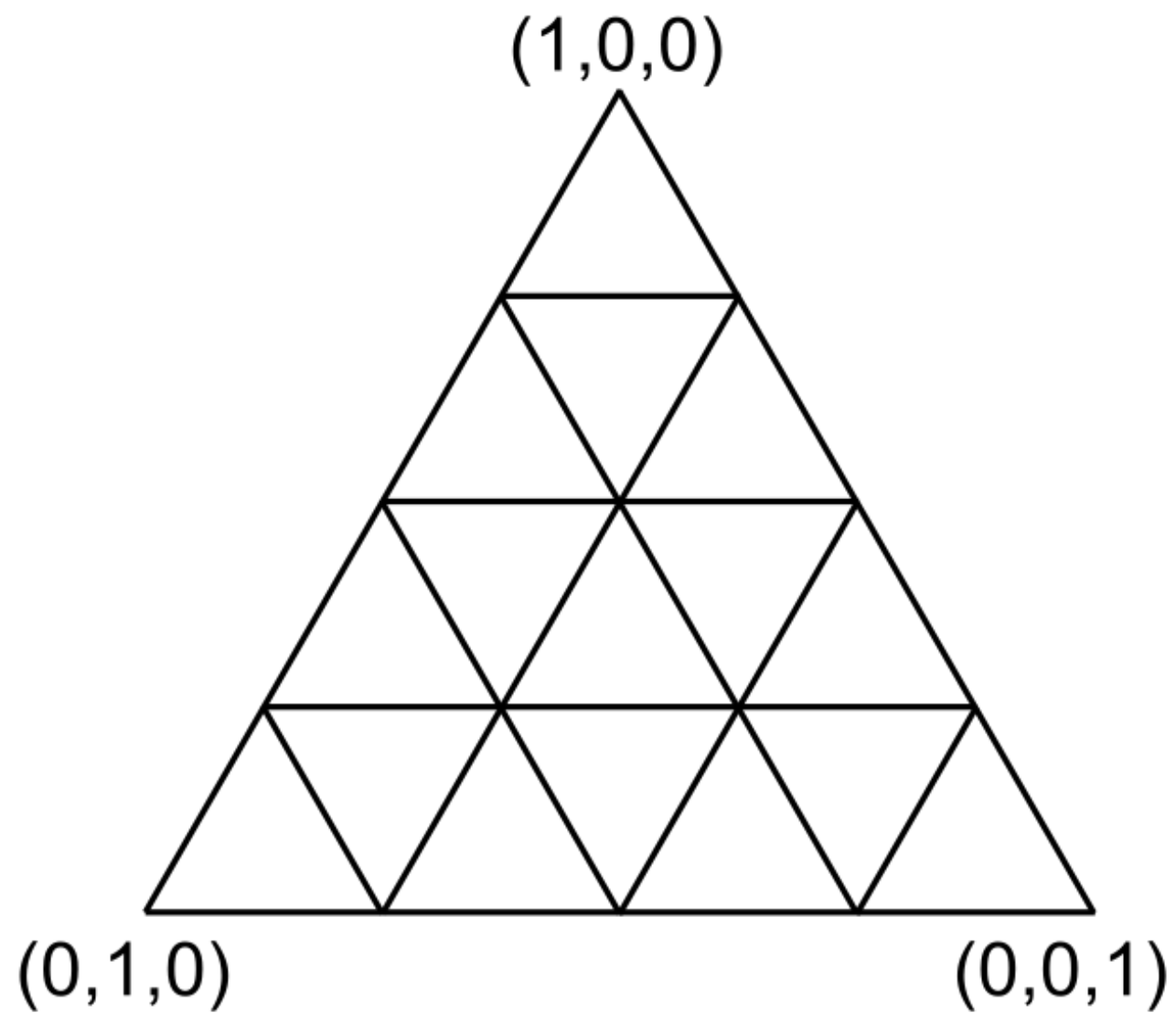
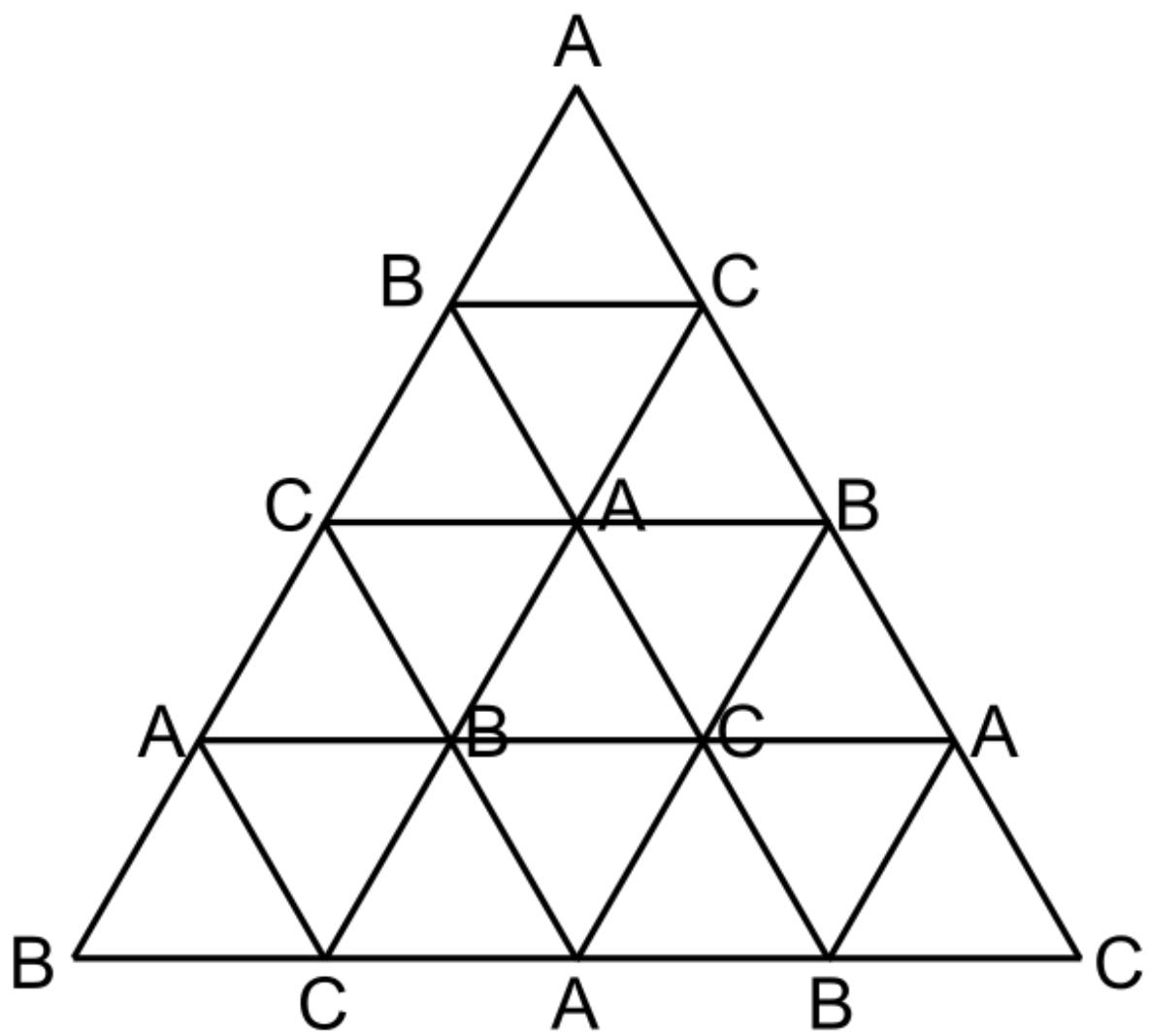

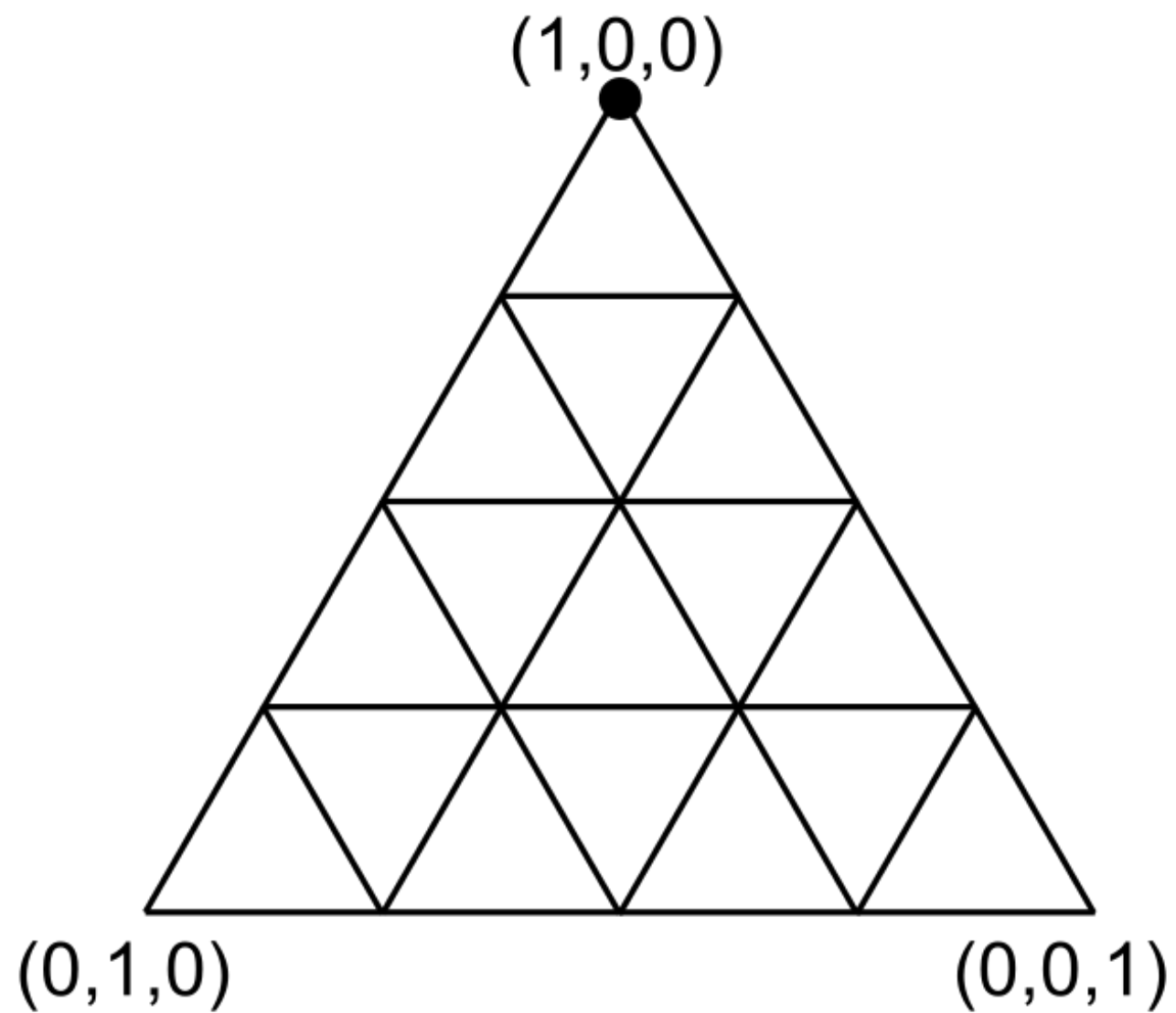
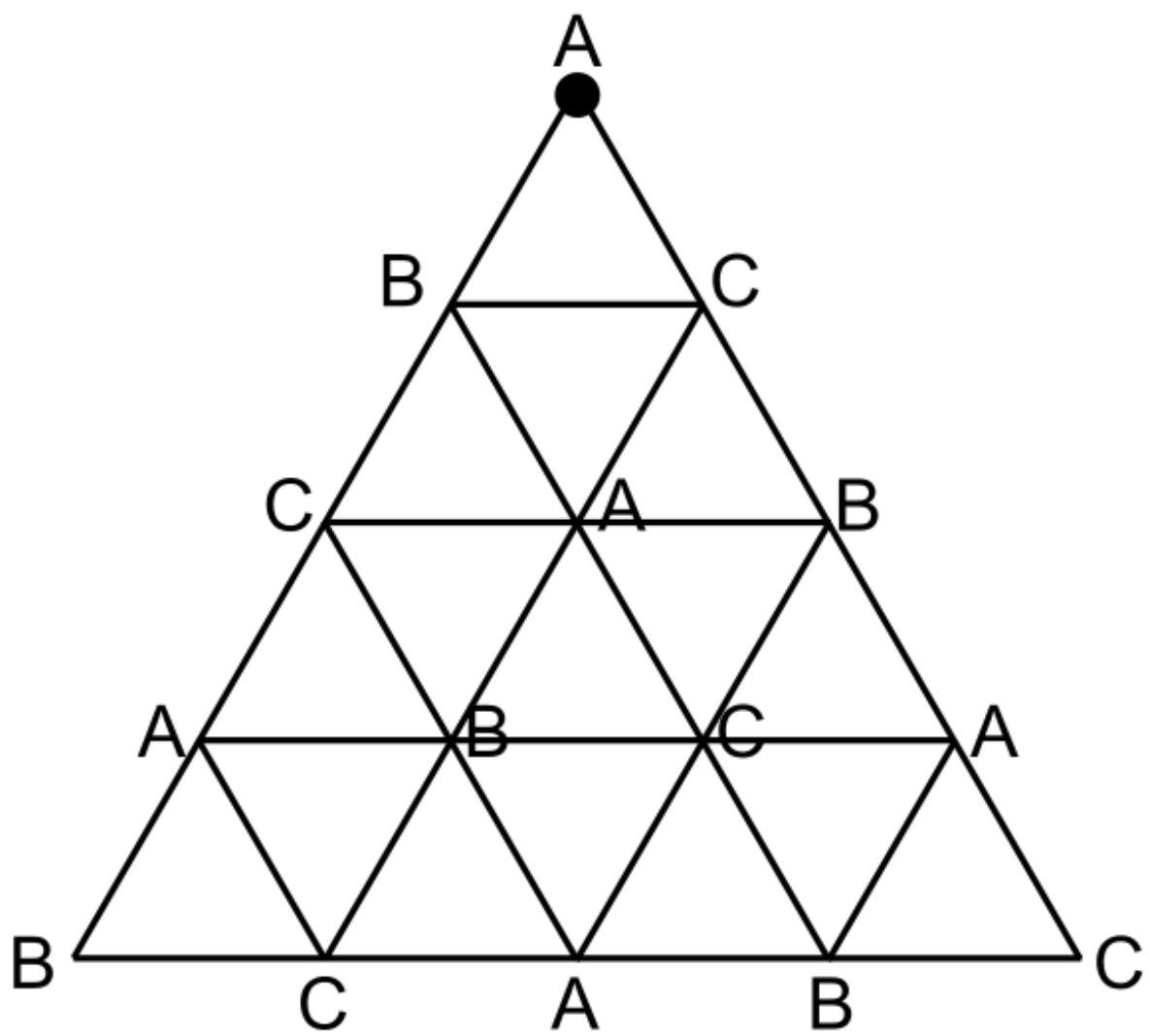

"Miserly agents" assumption
Agents always prefer a *free* room over a room with non-zero rent.

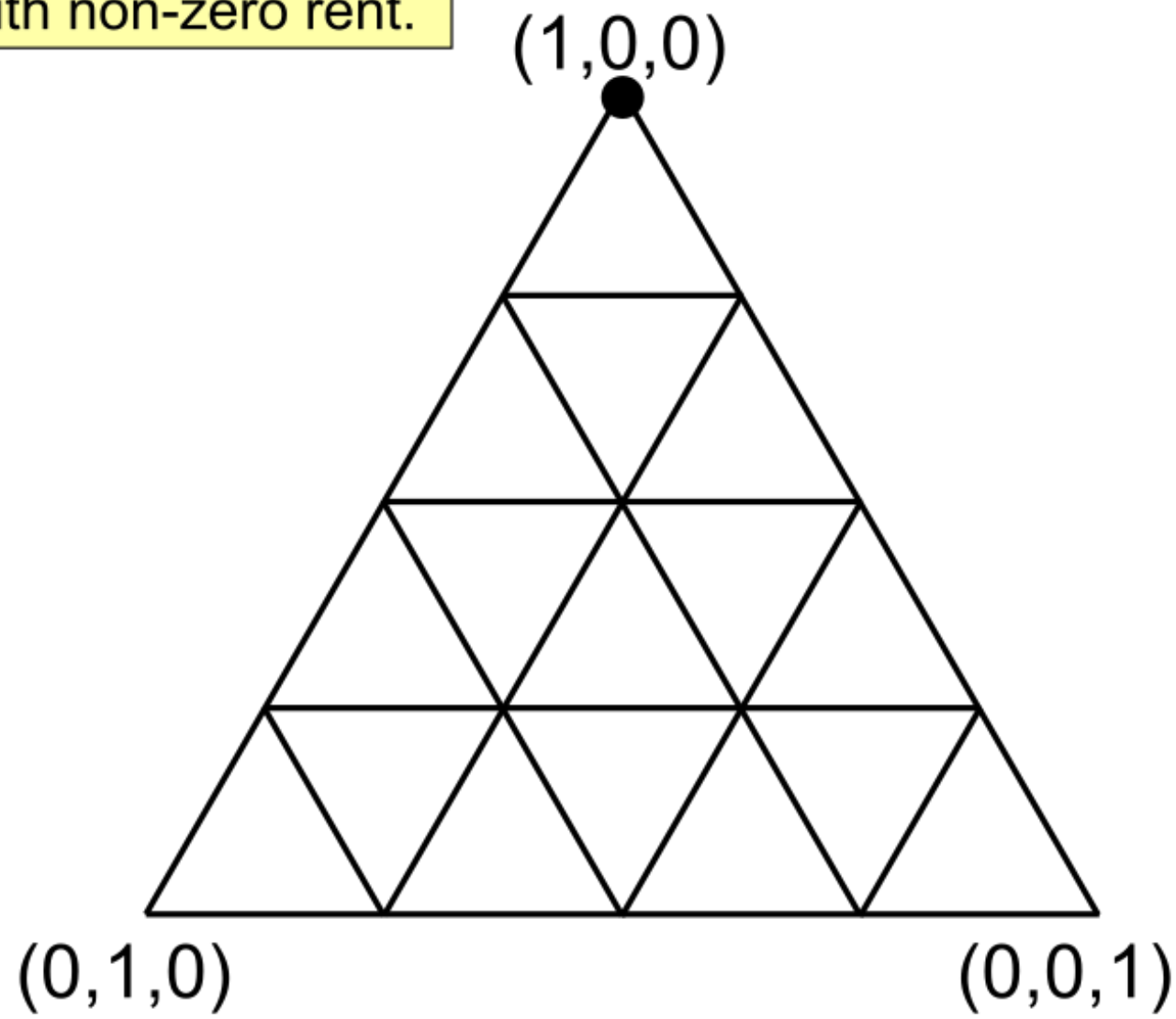
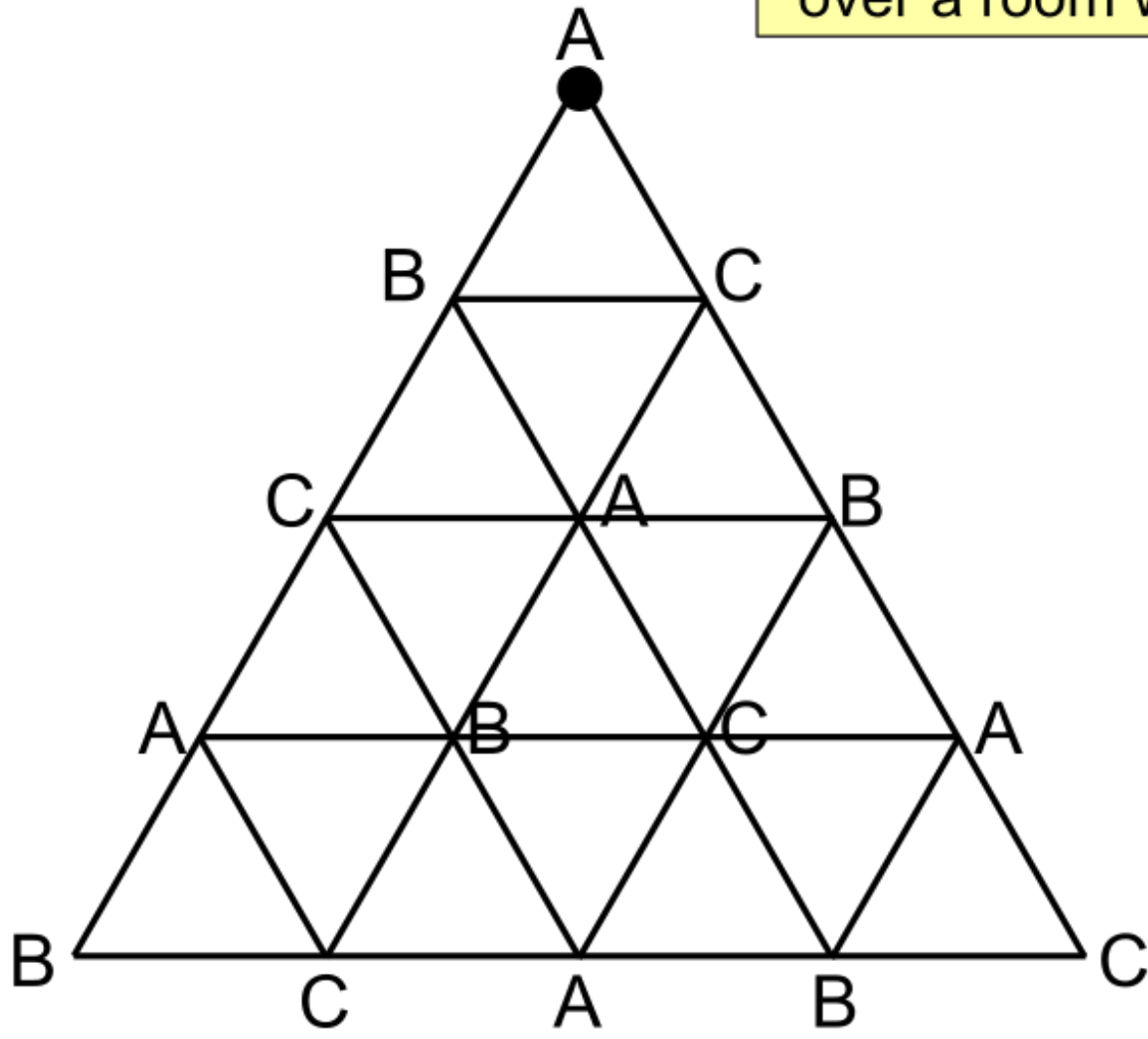

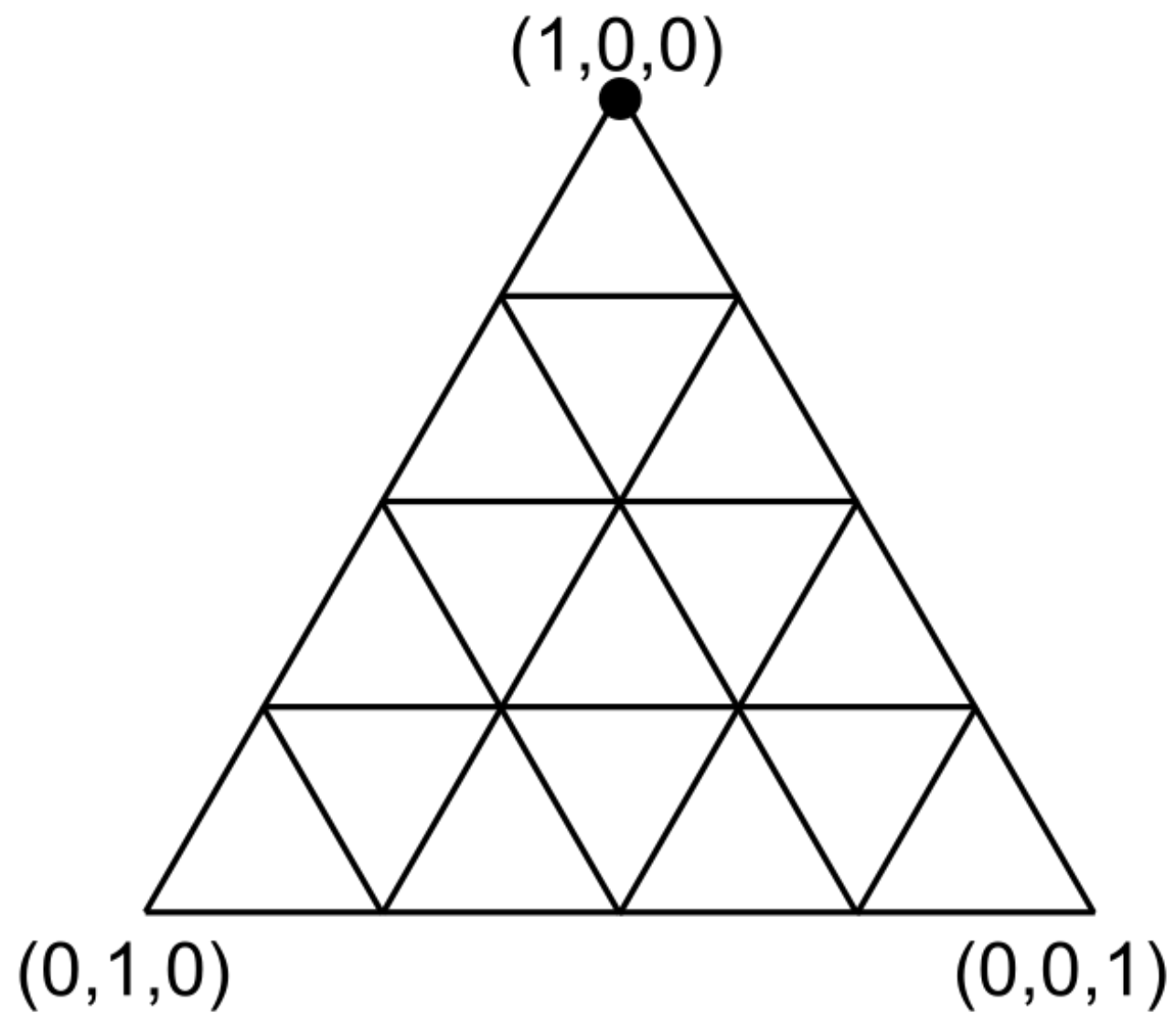
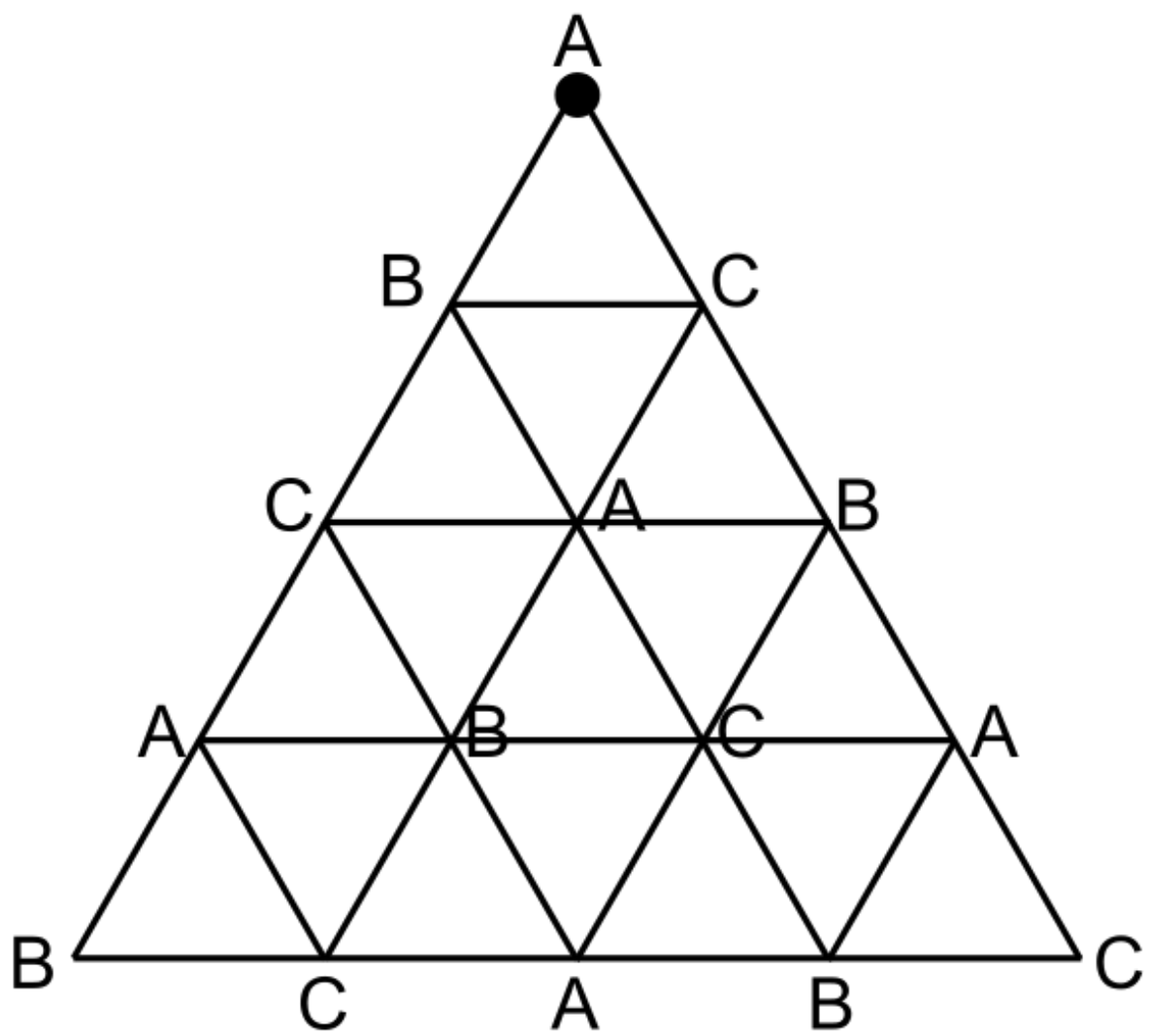

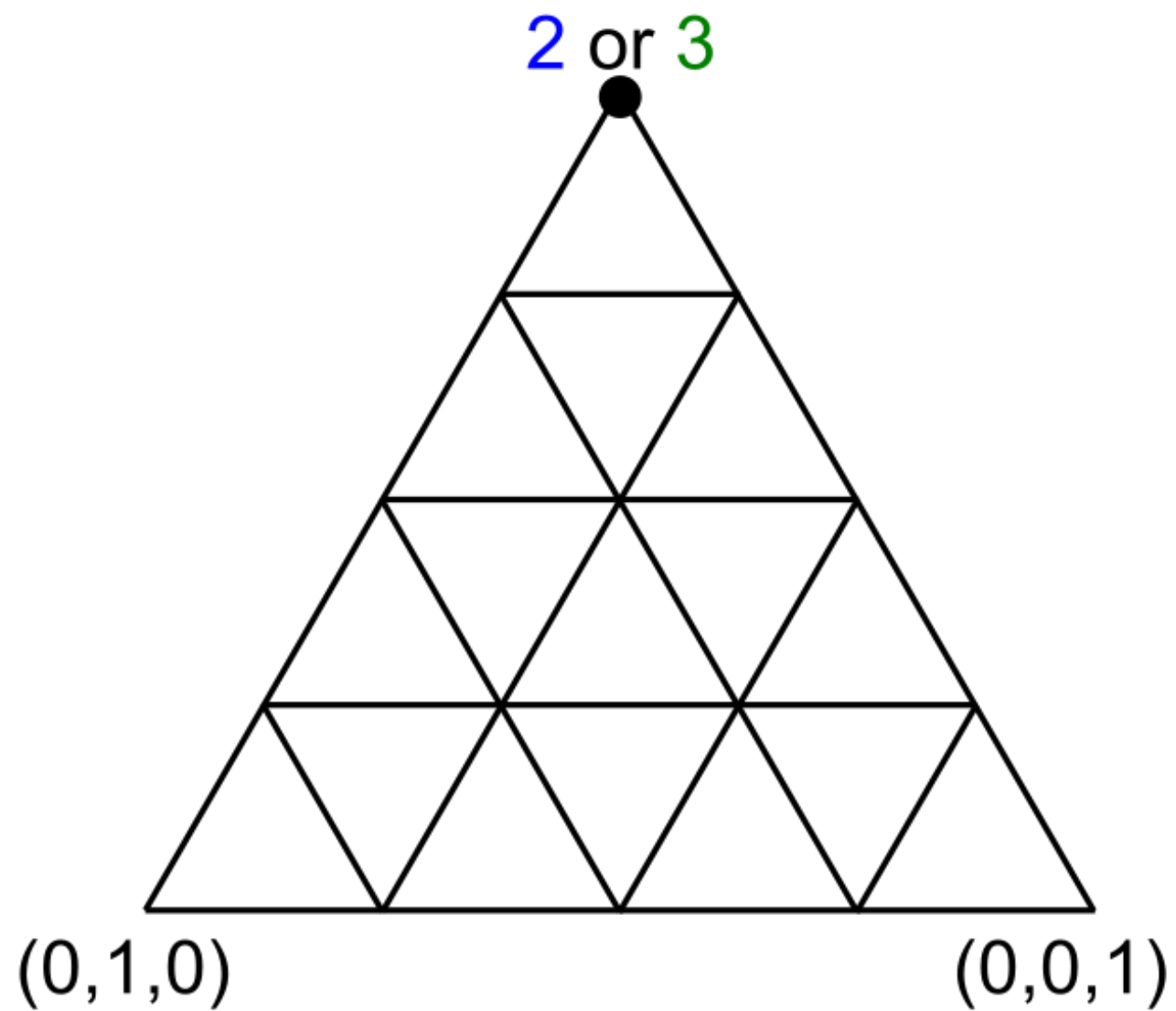
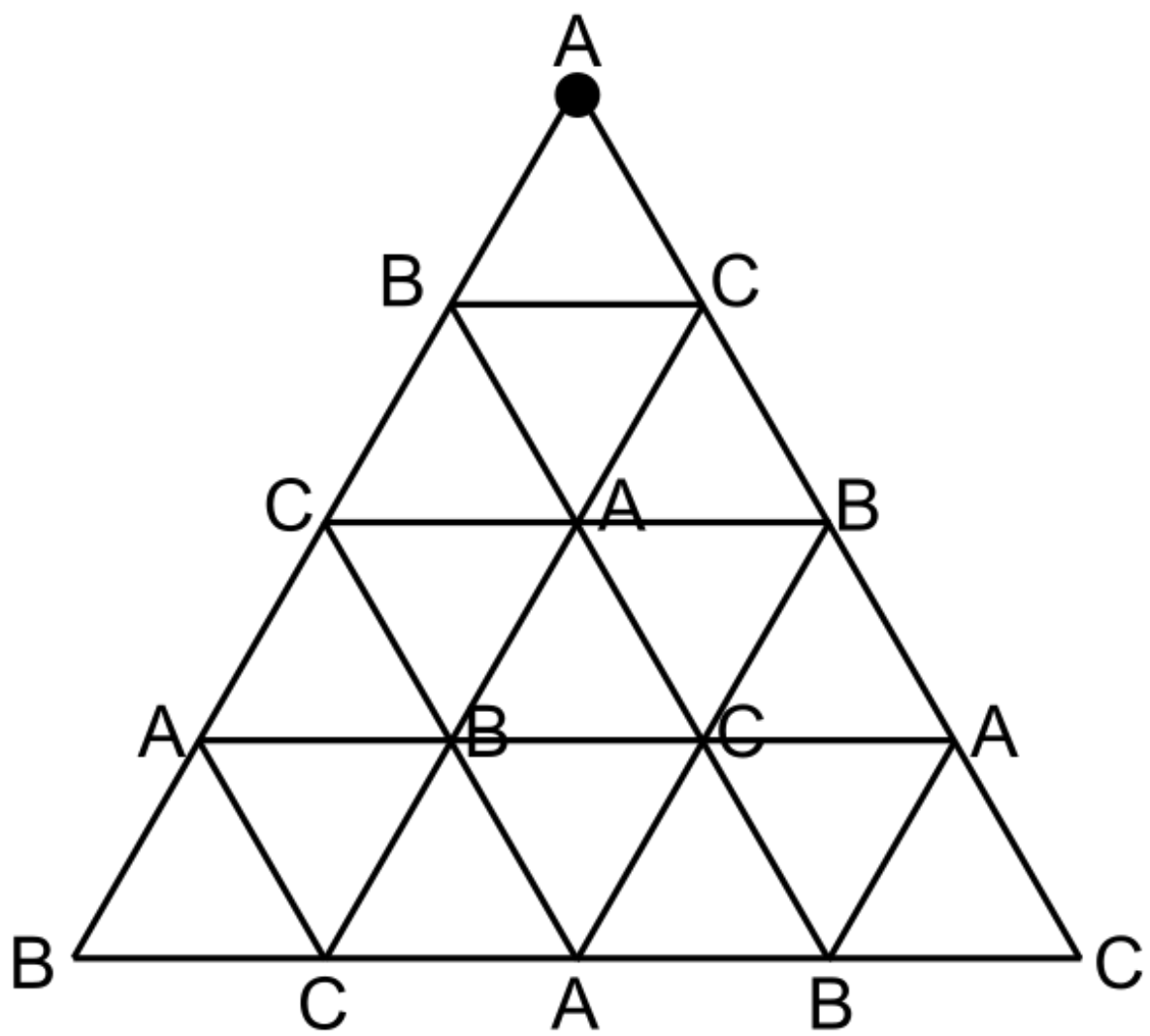

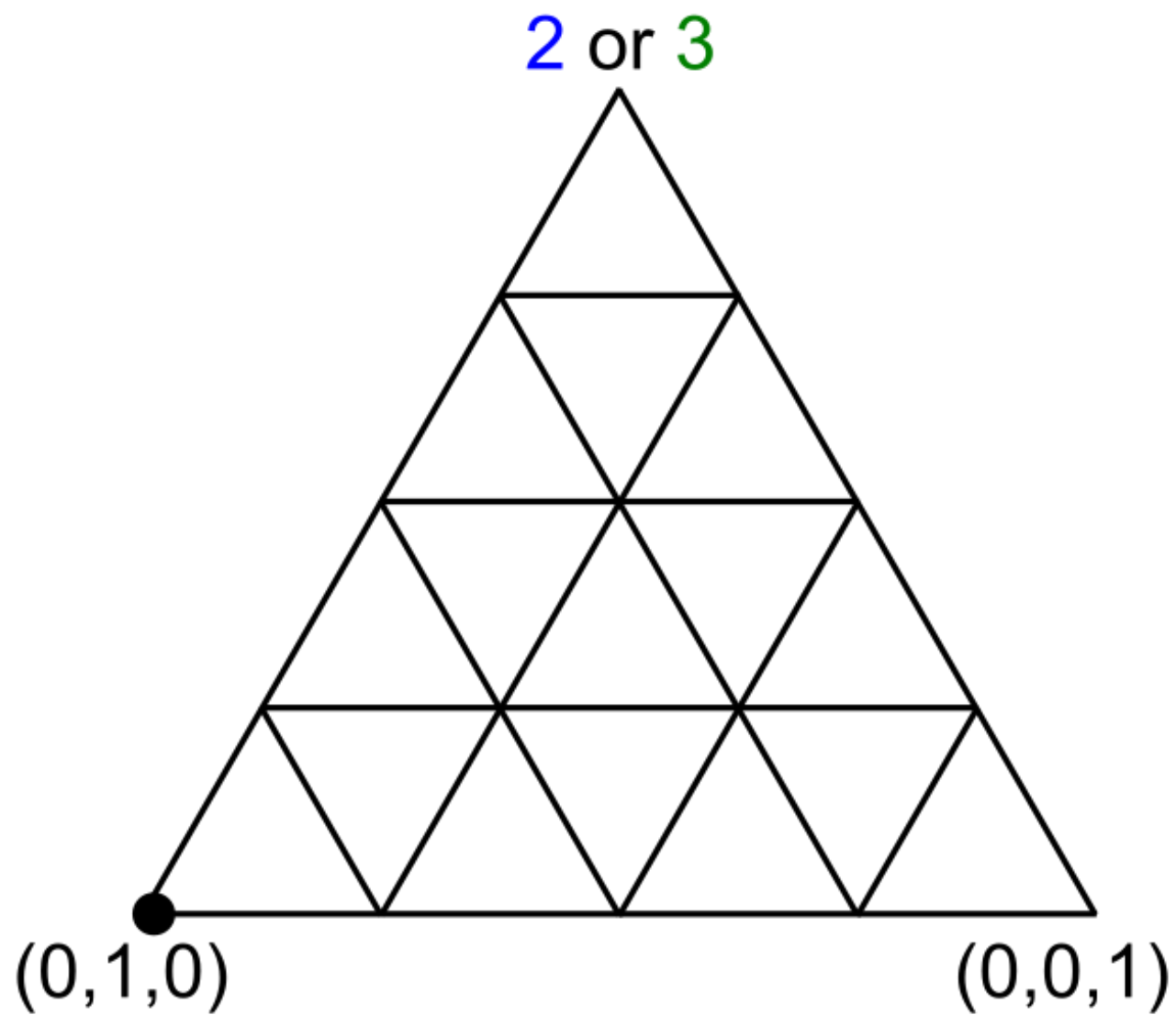
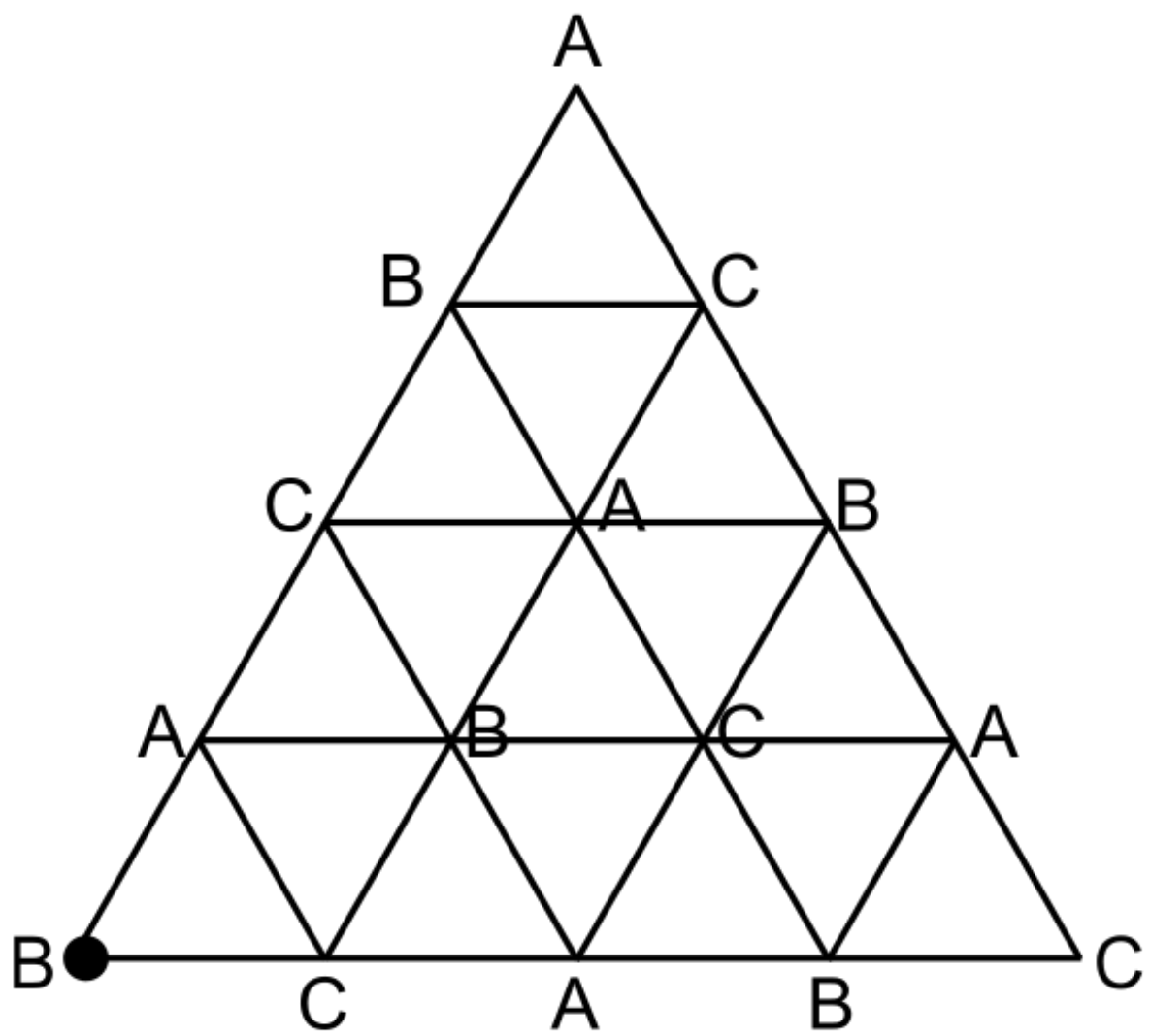

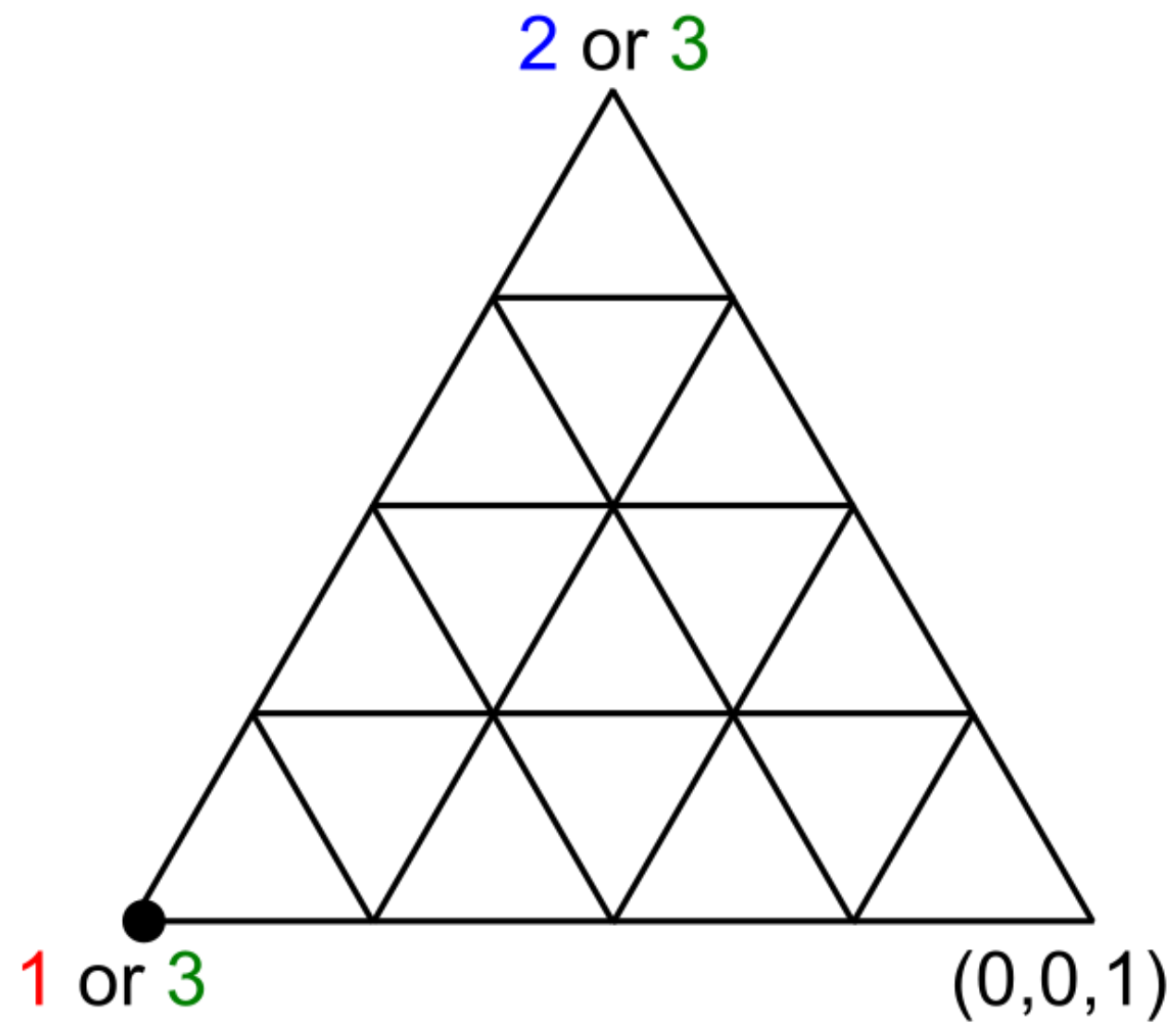
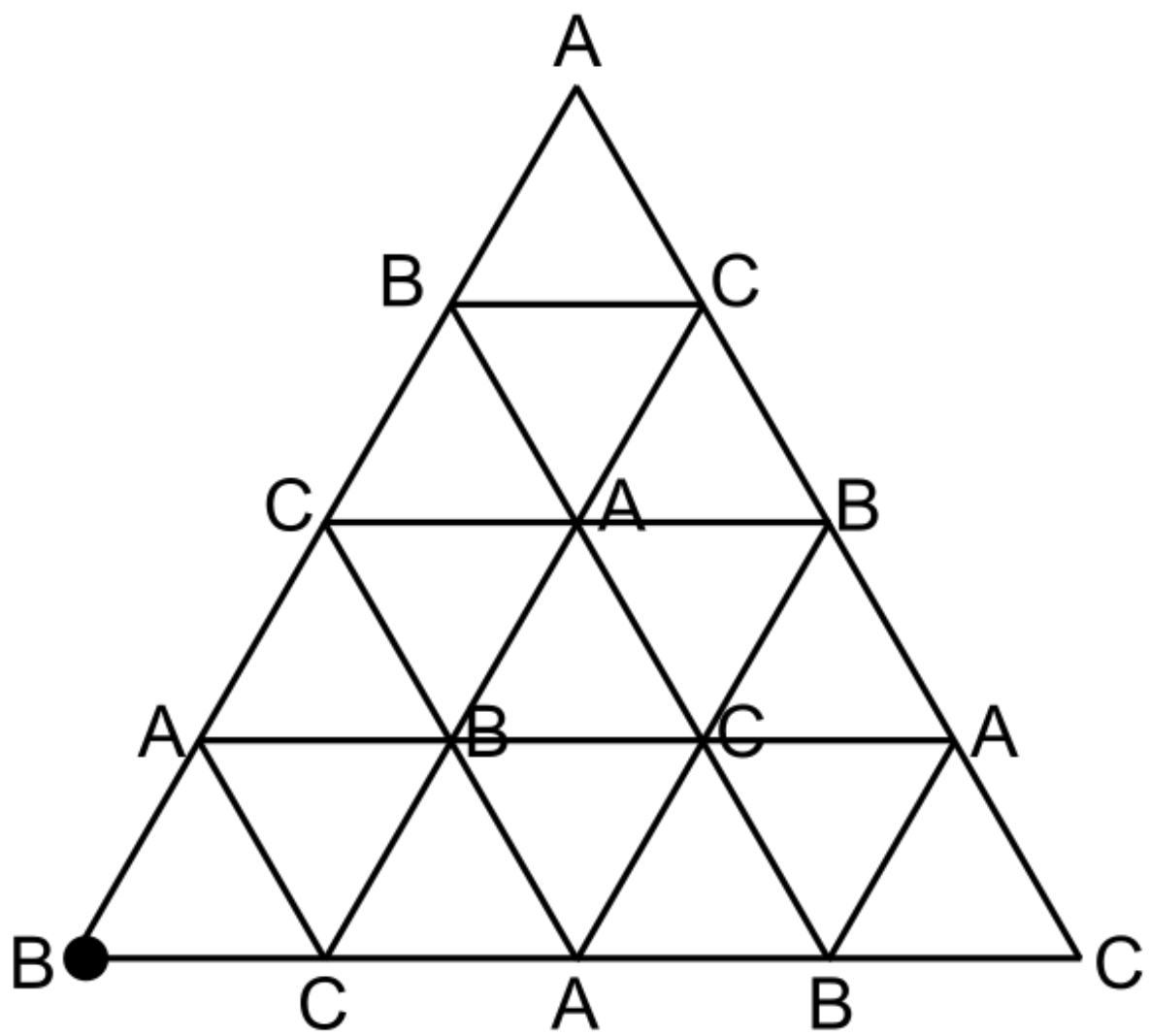

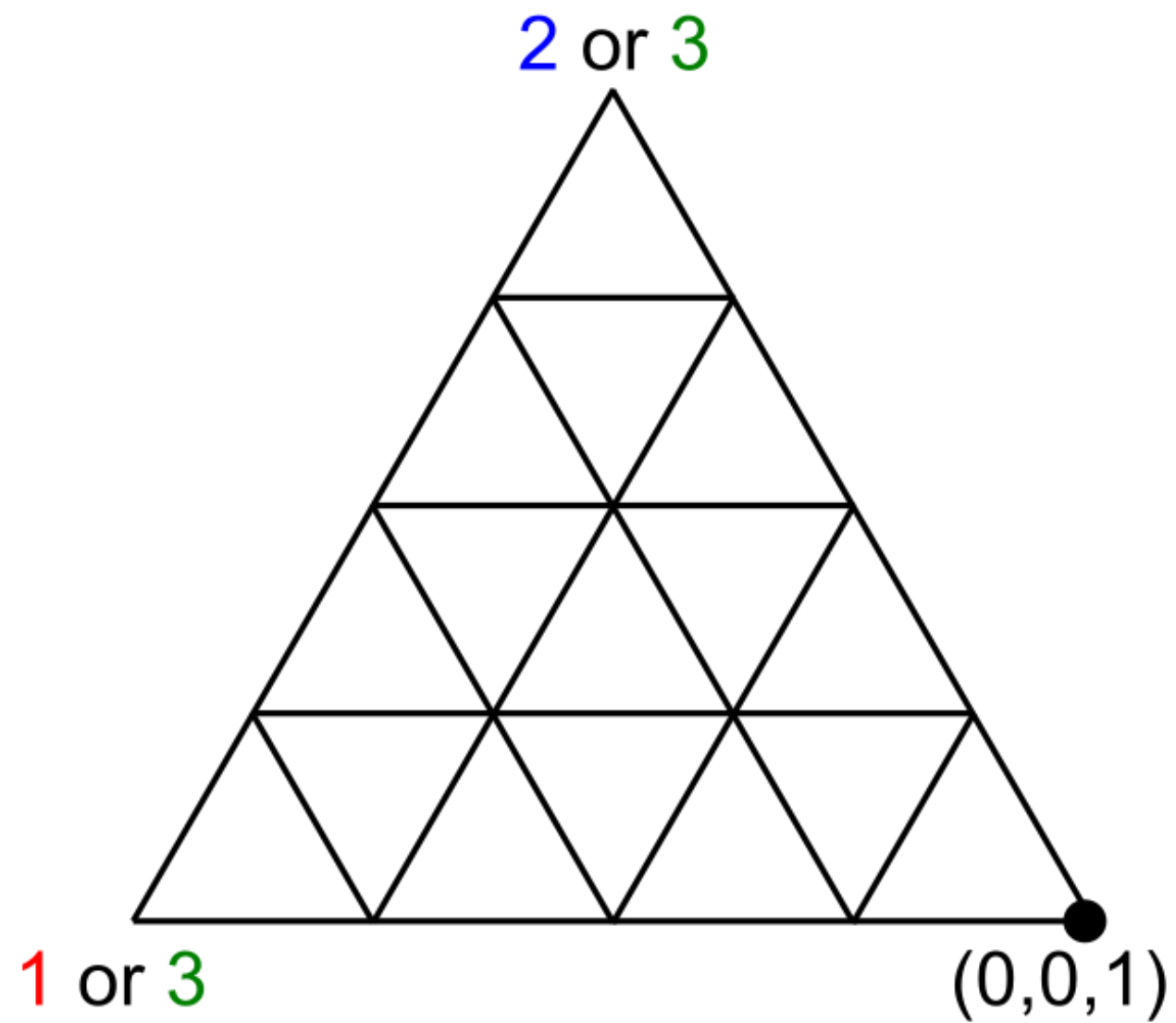
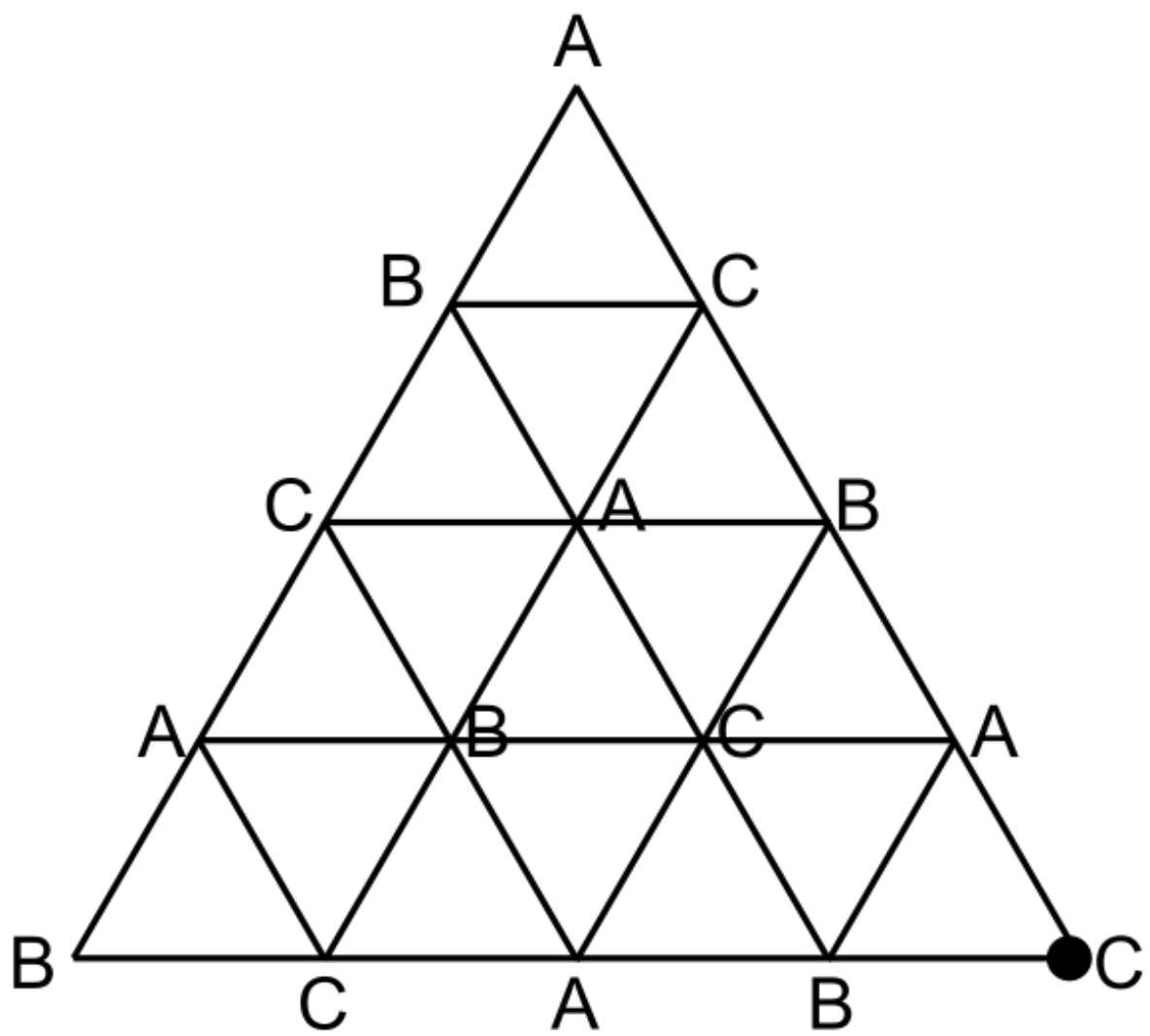

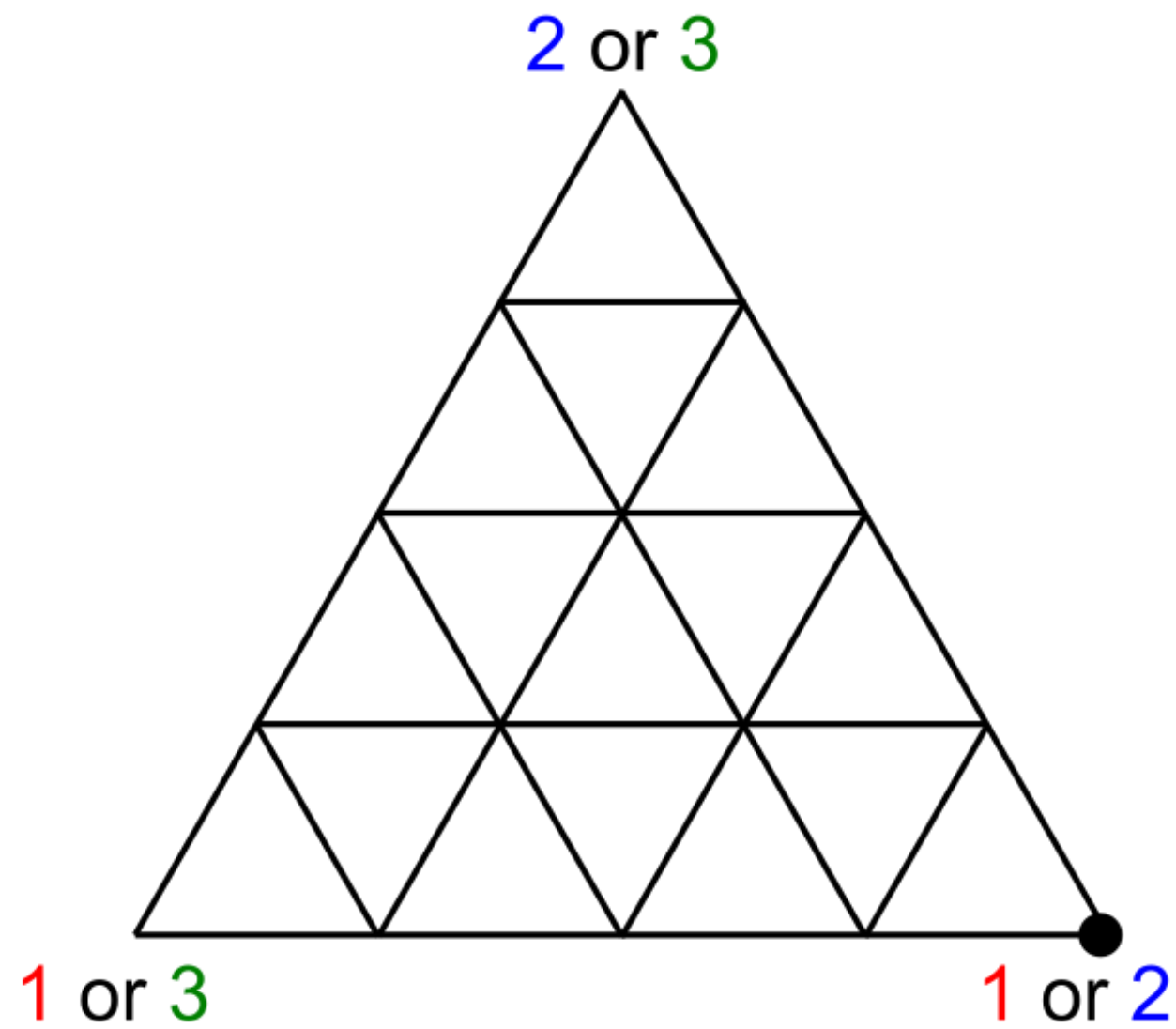
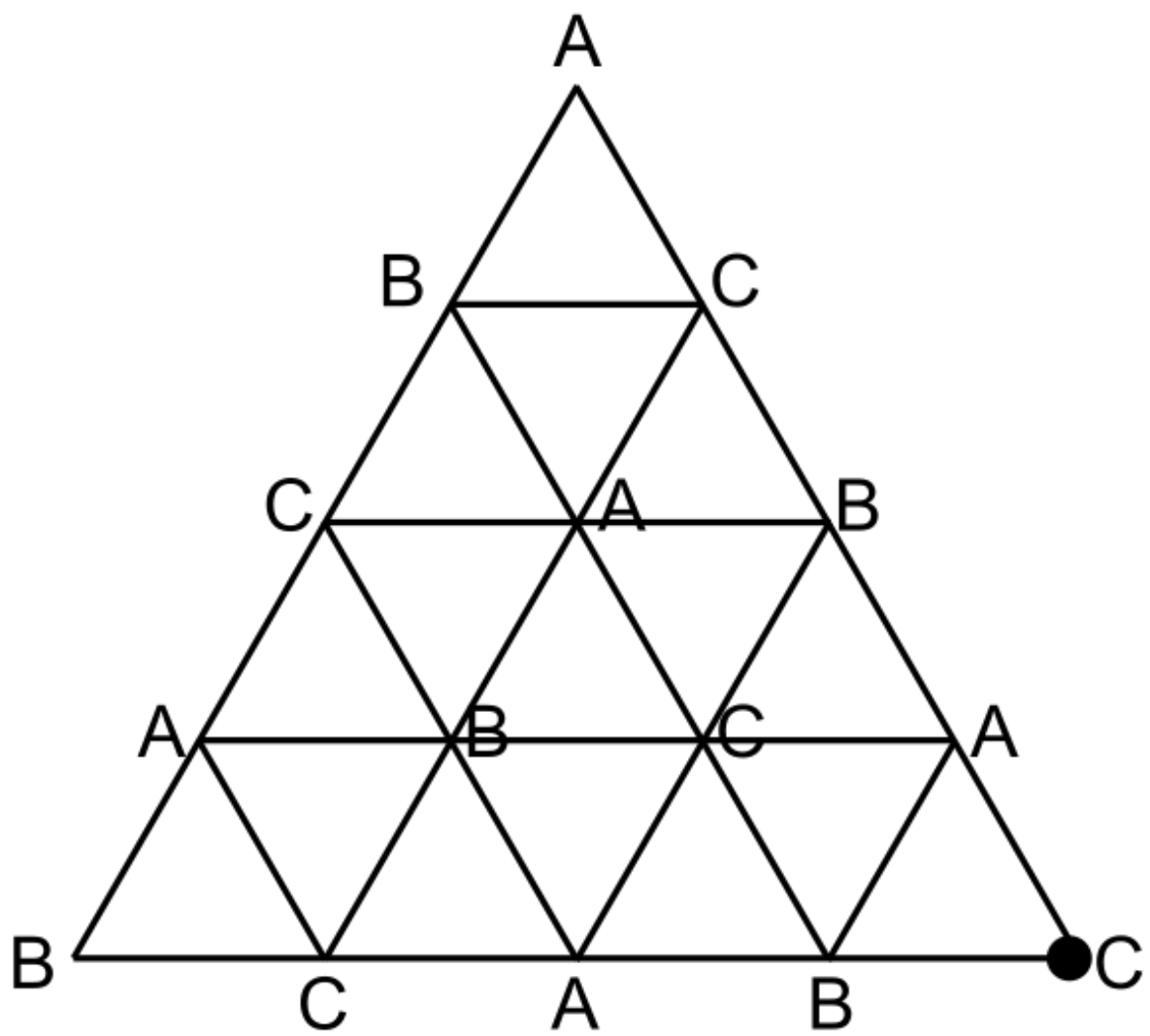

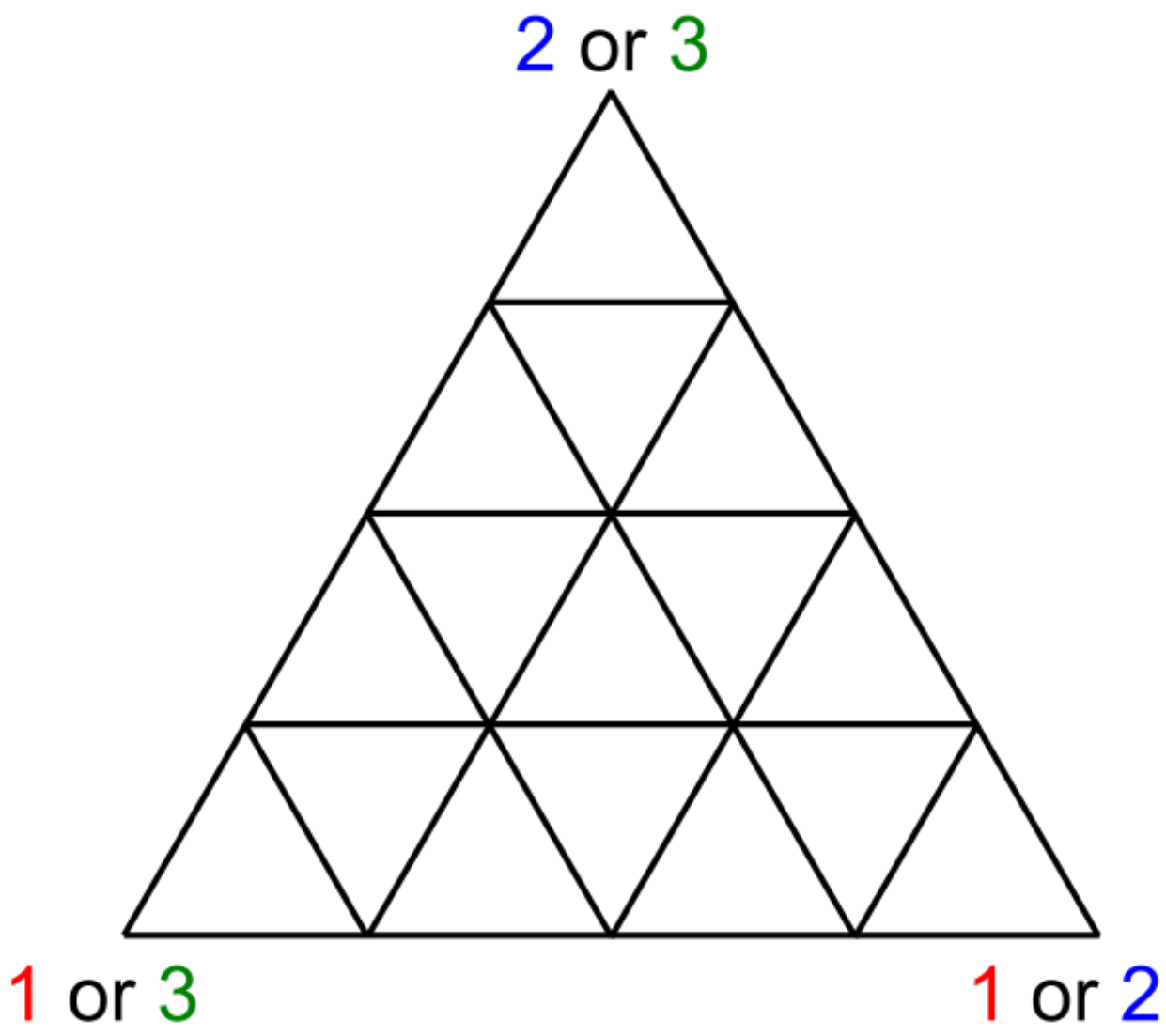
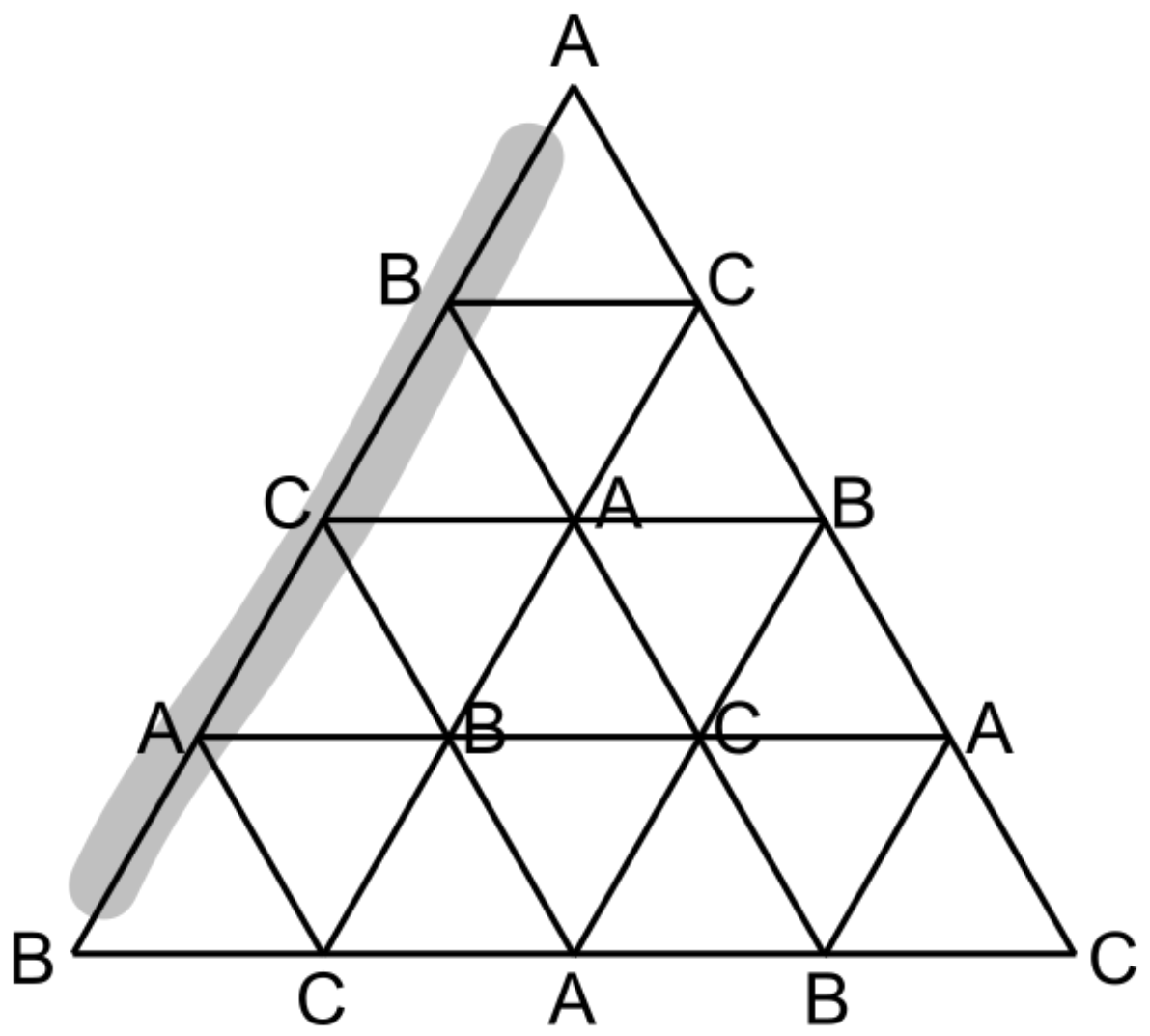

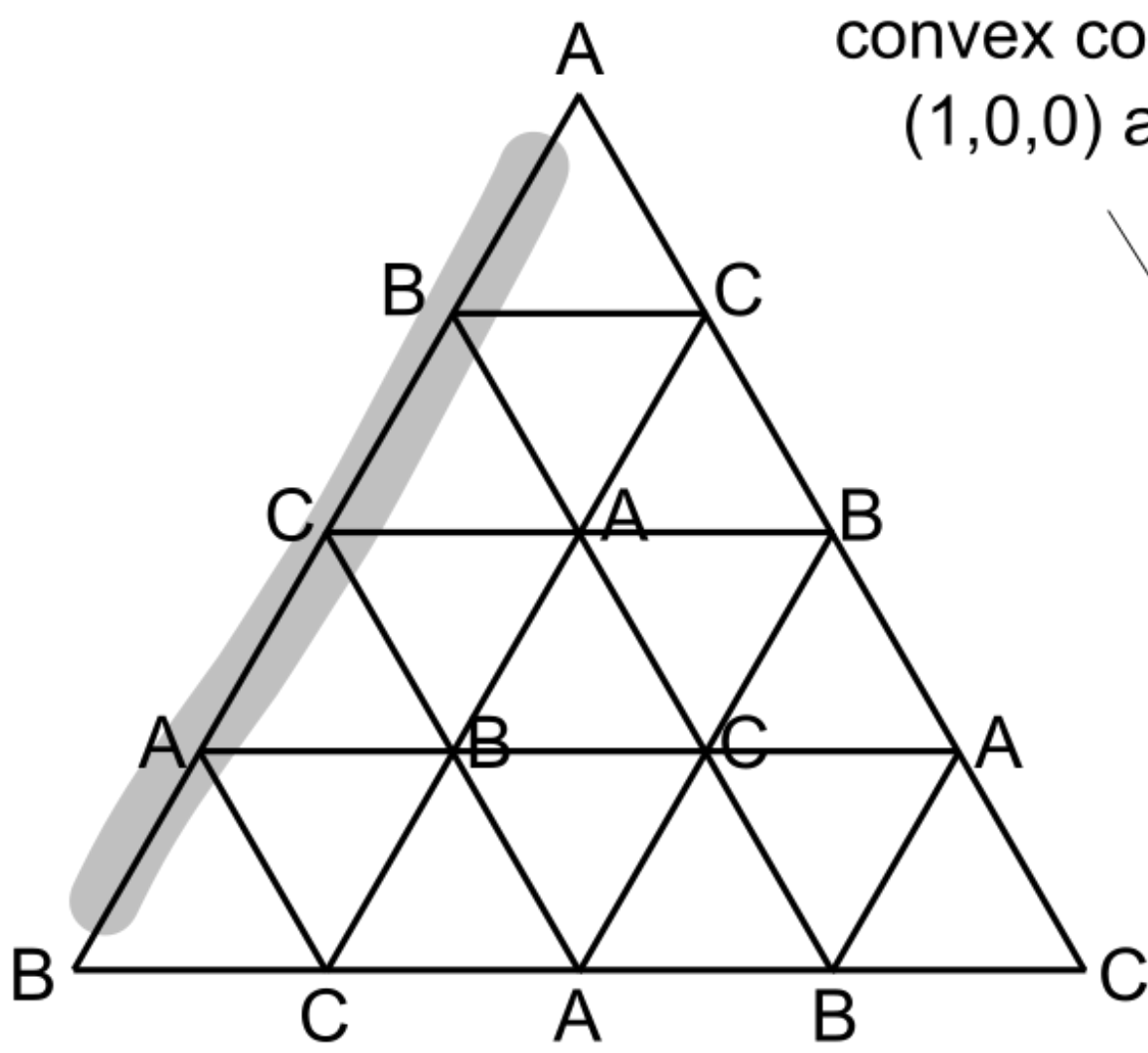

convex combination of
 $(1,0,0)$ and $(0,1,0)$

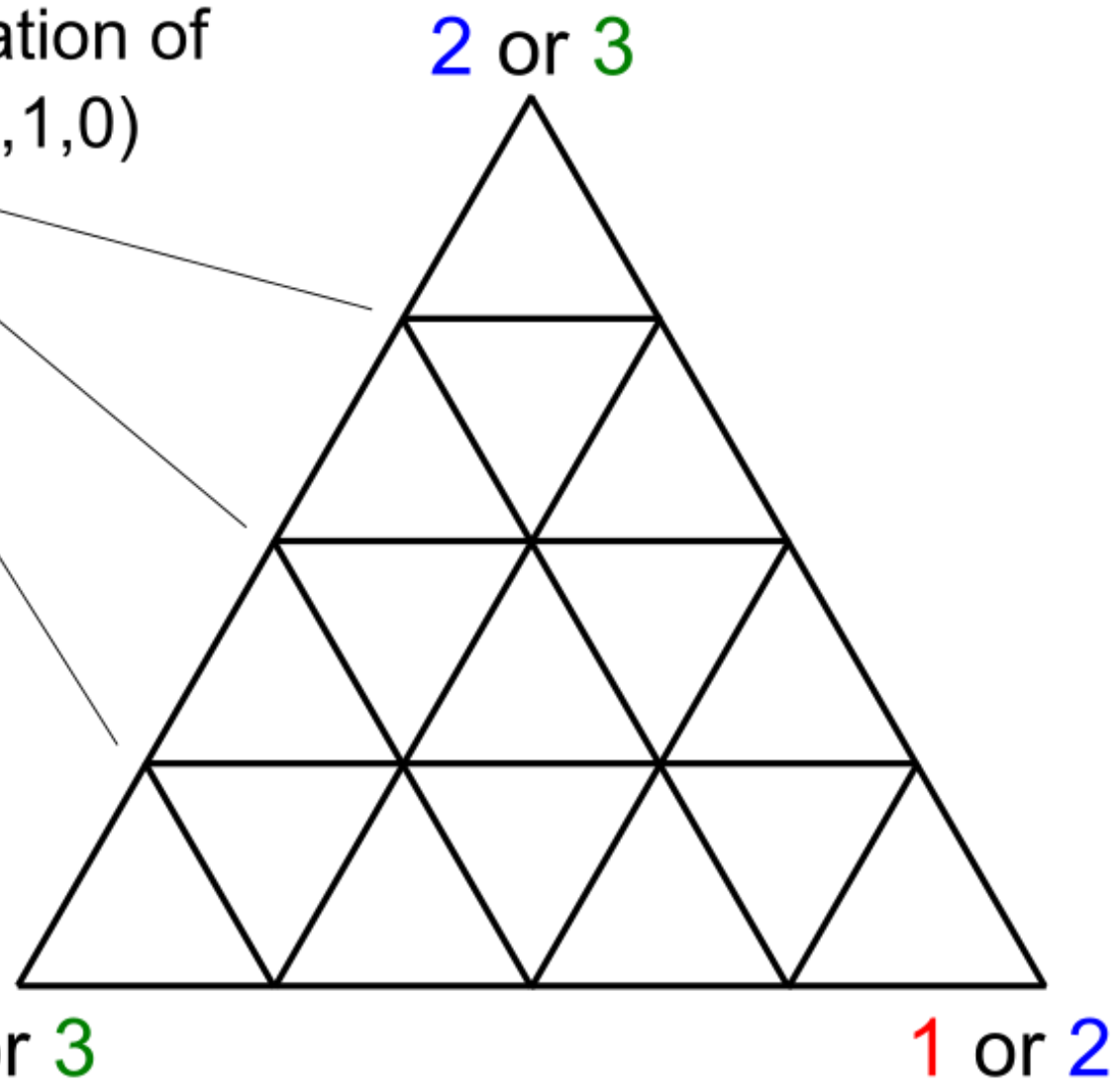

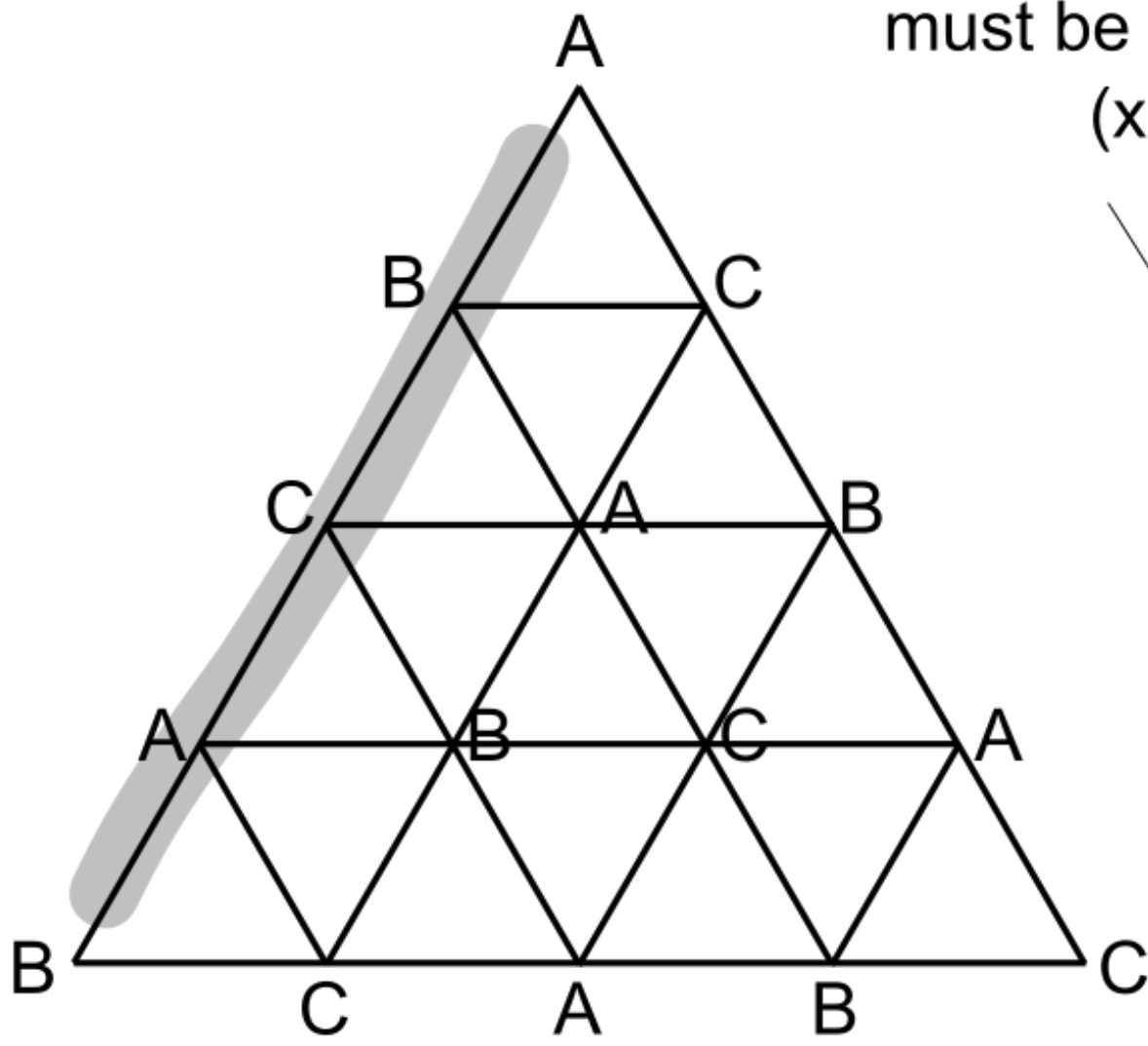

must be of the form
 $(x,y,0)$

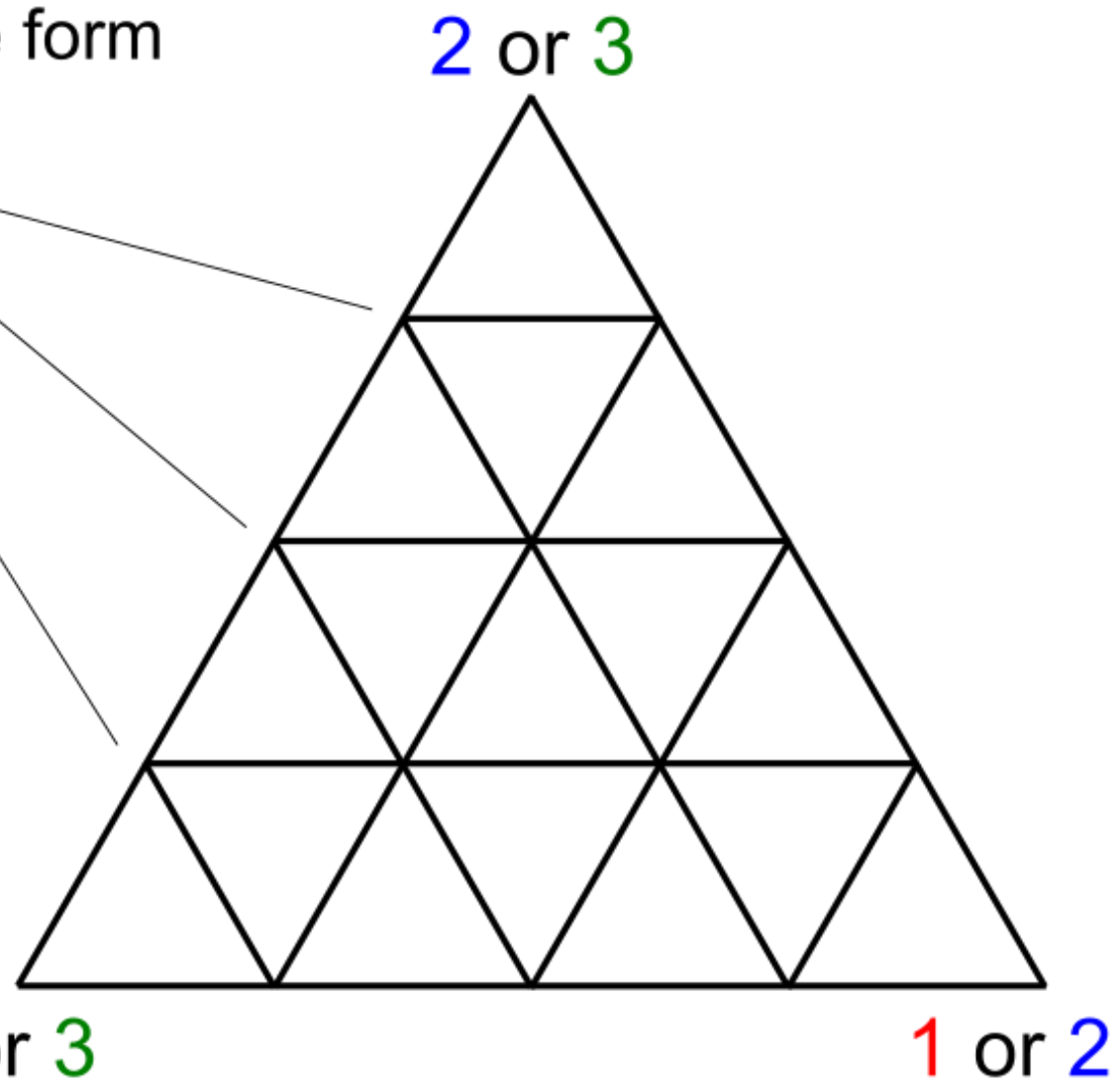

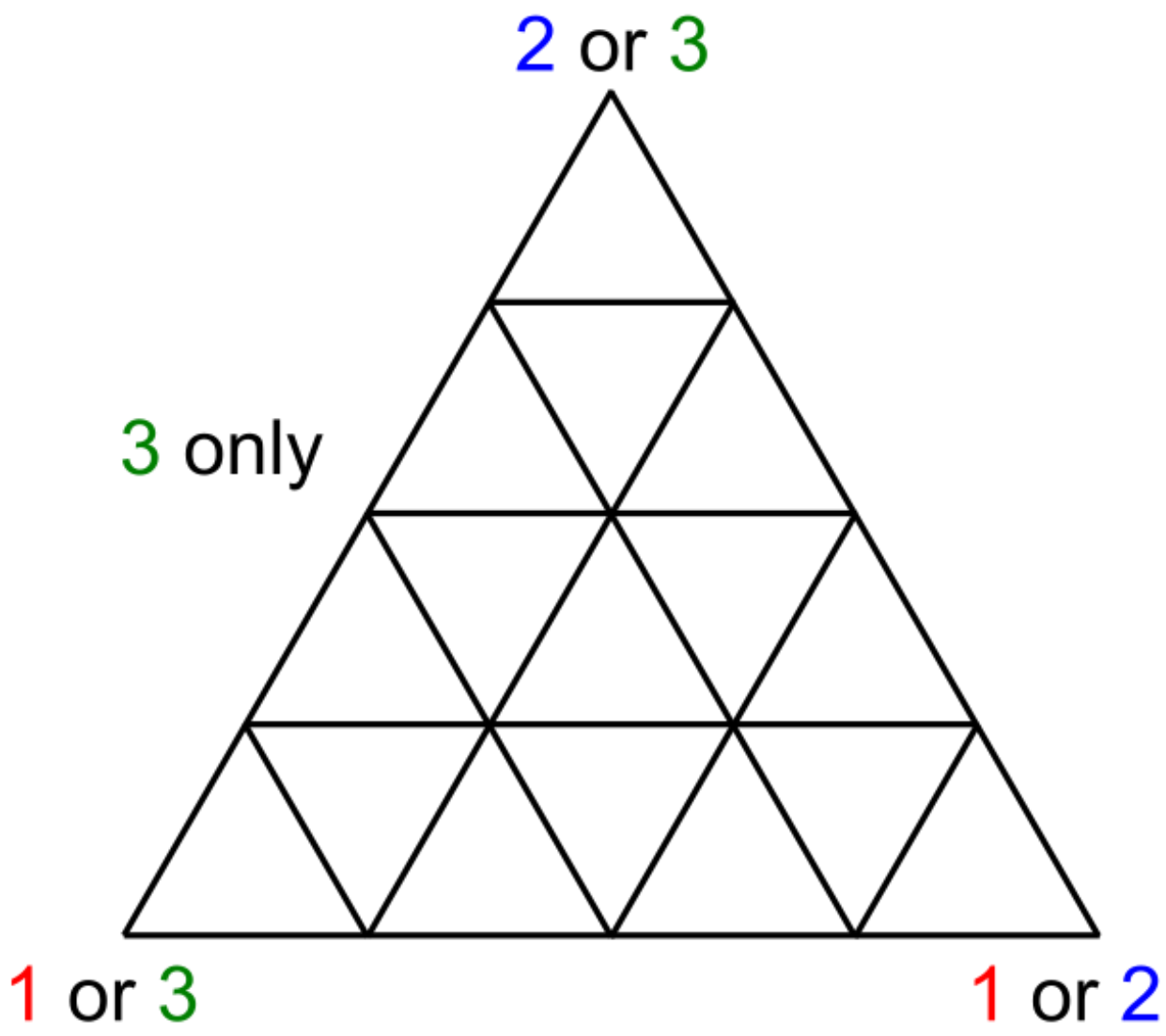
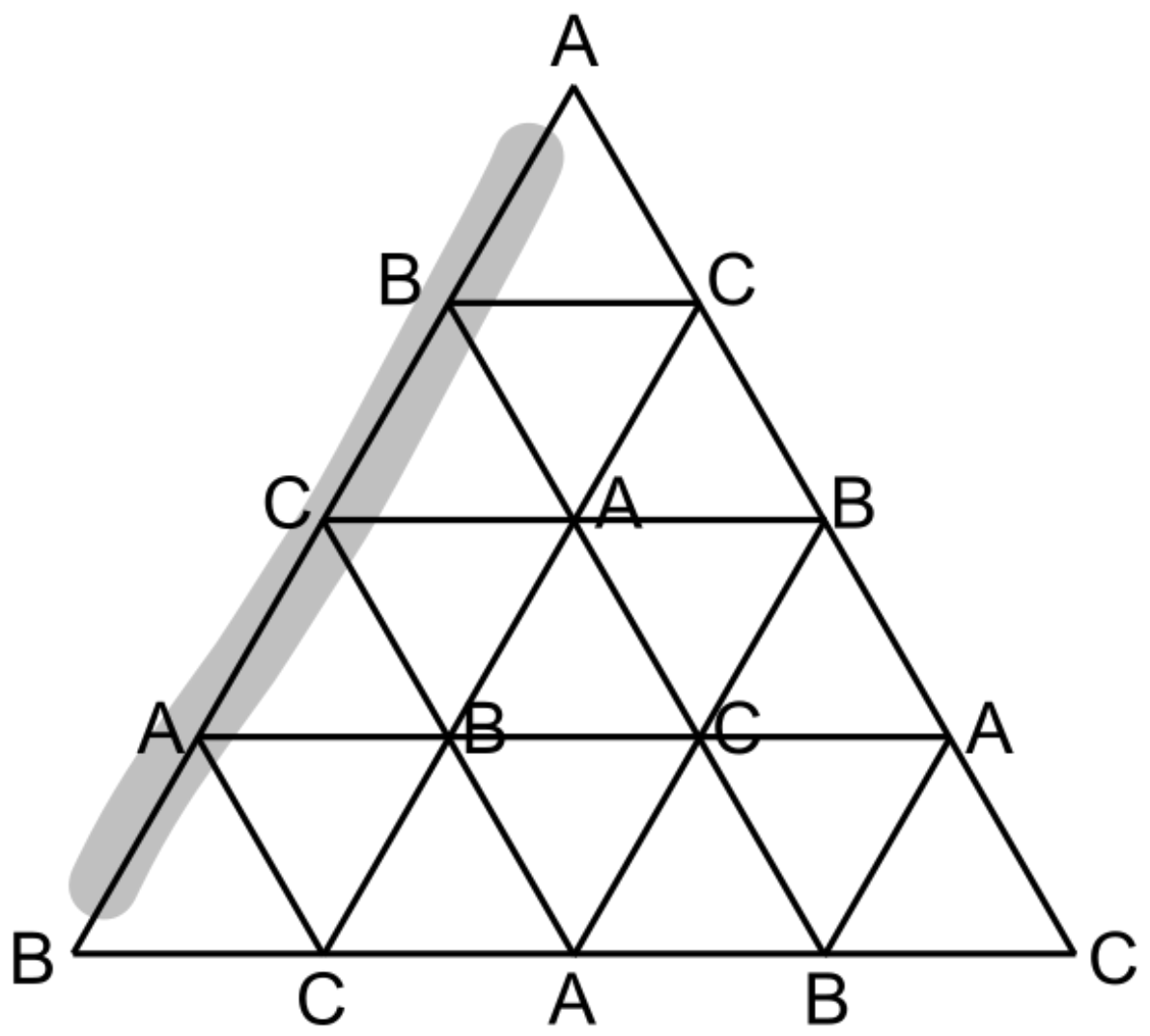

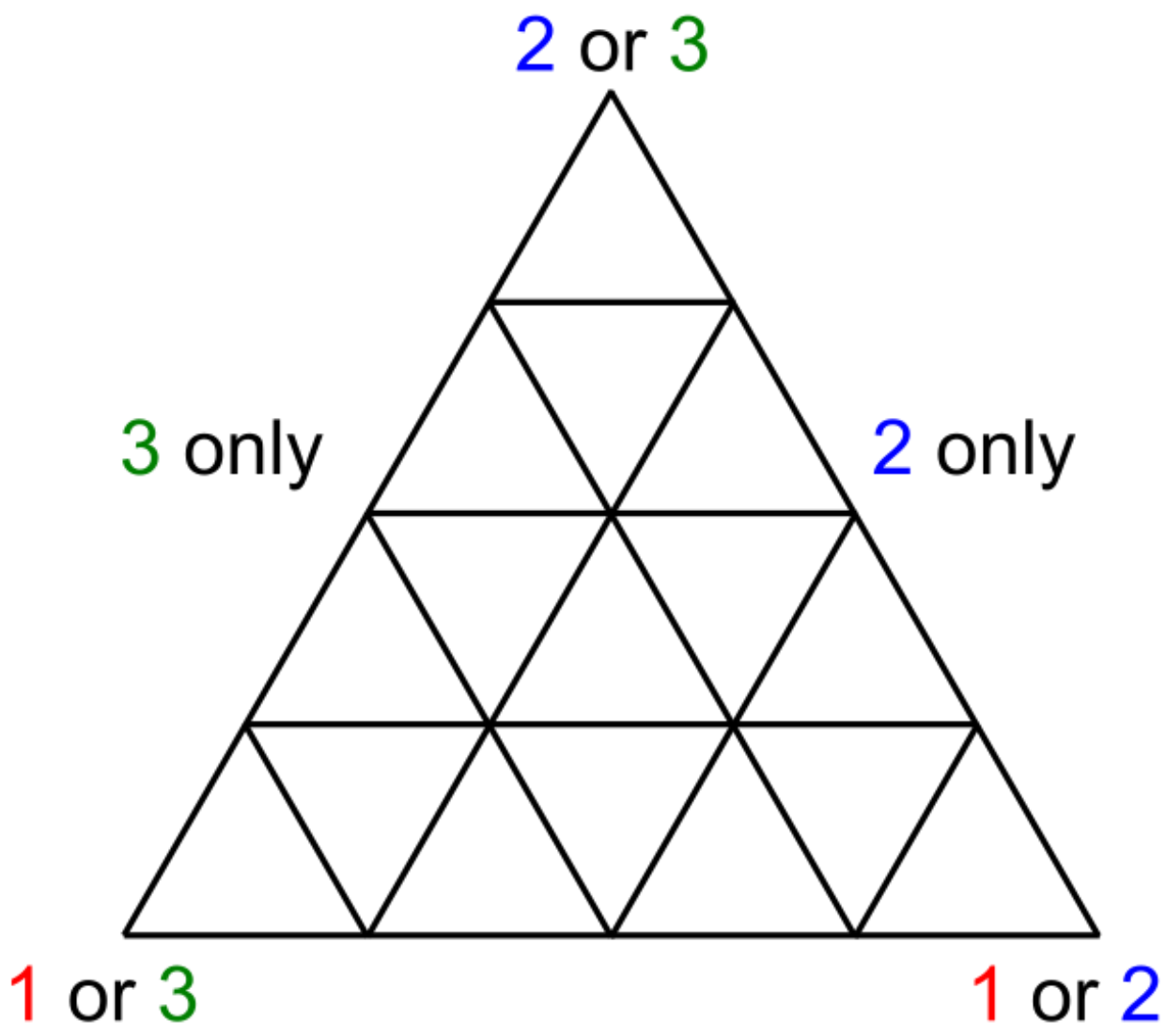
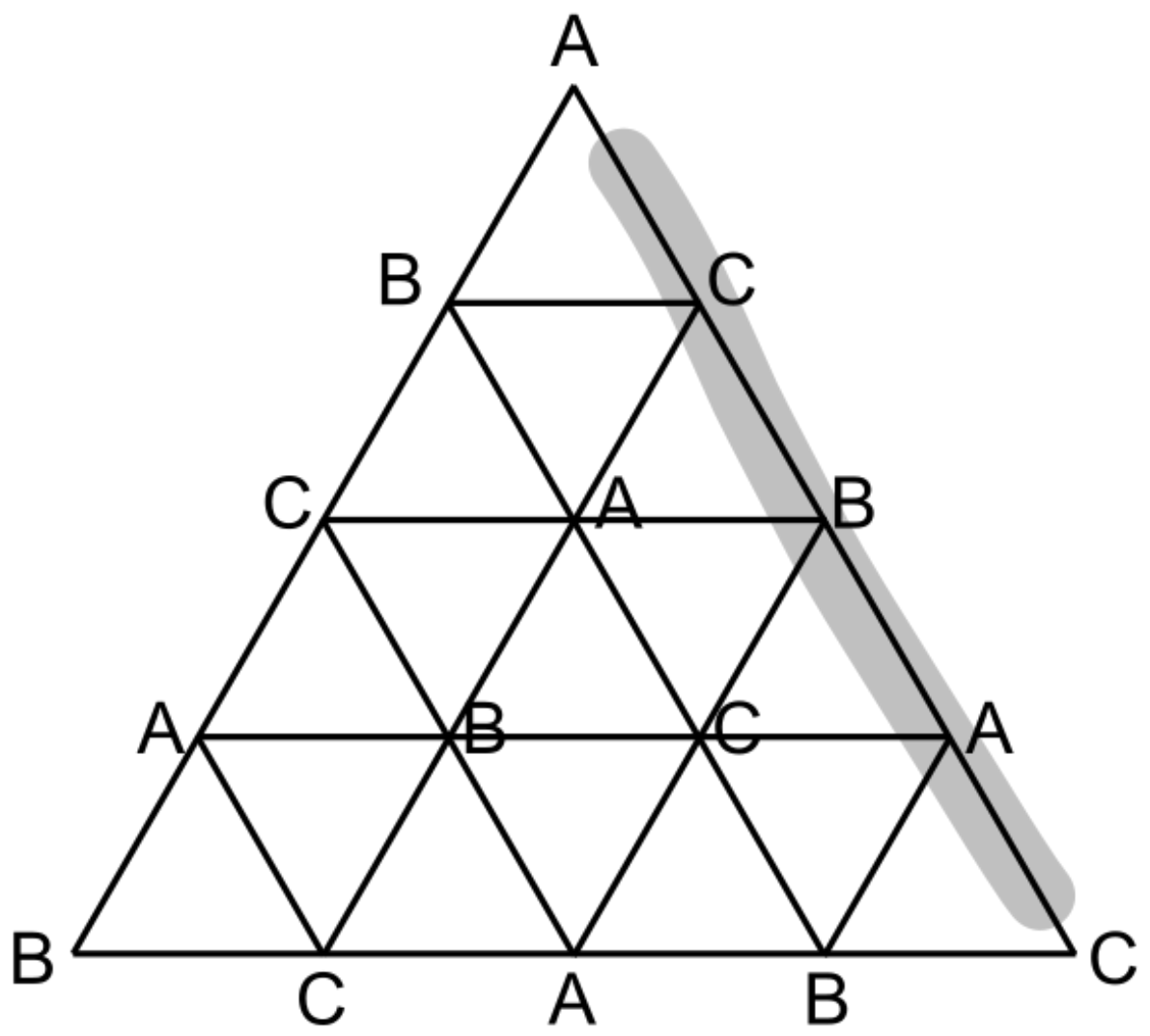

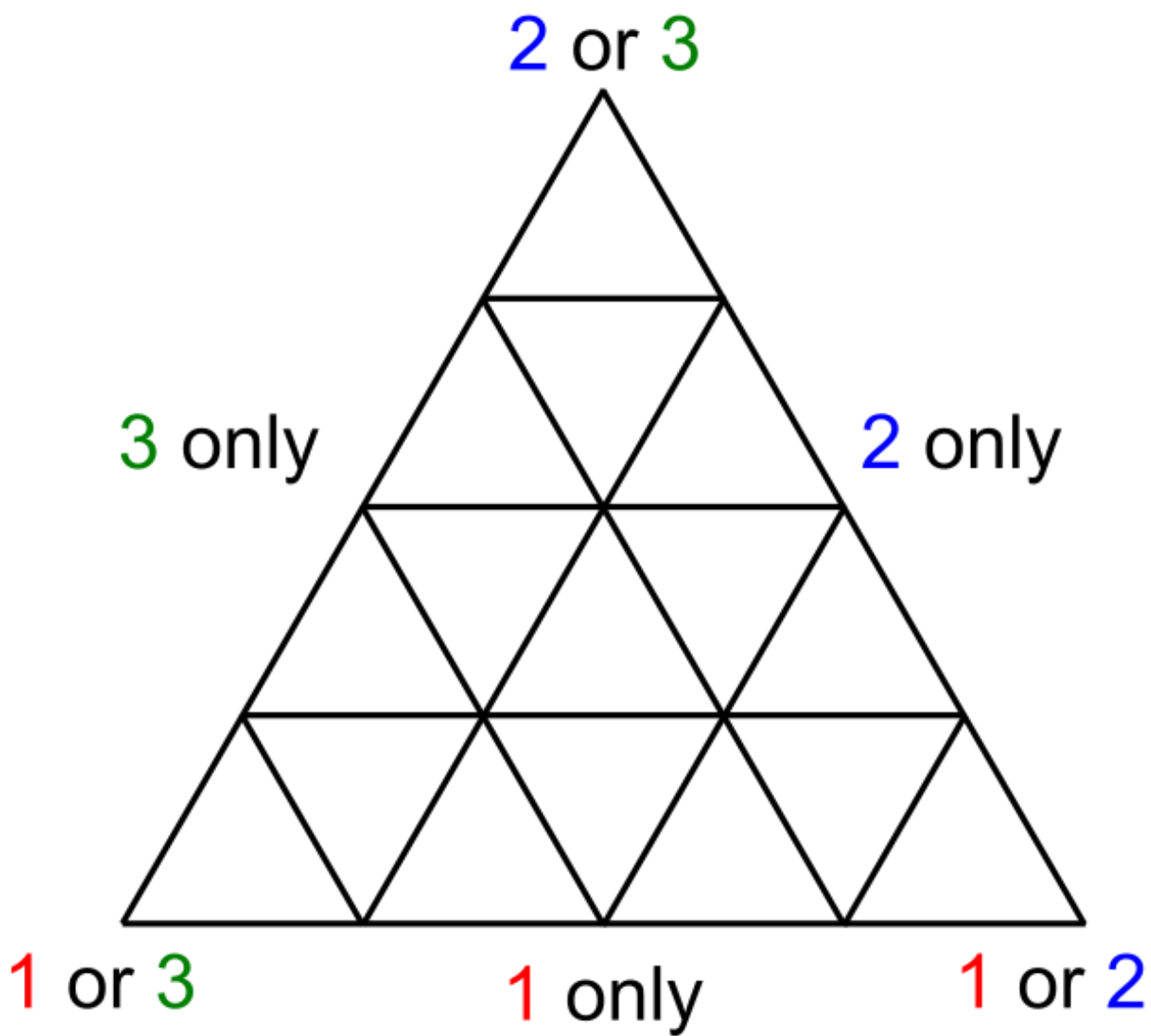
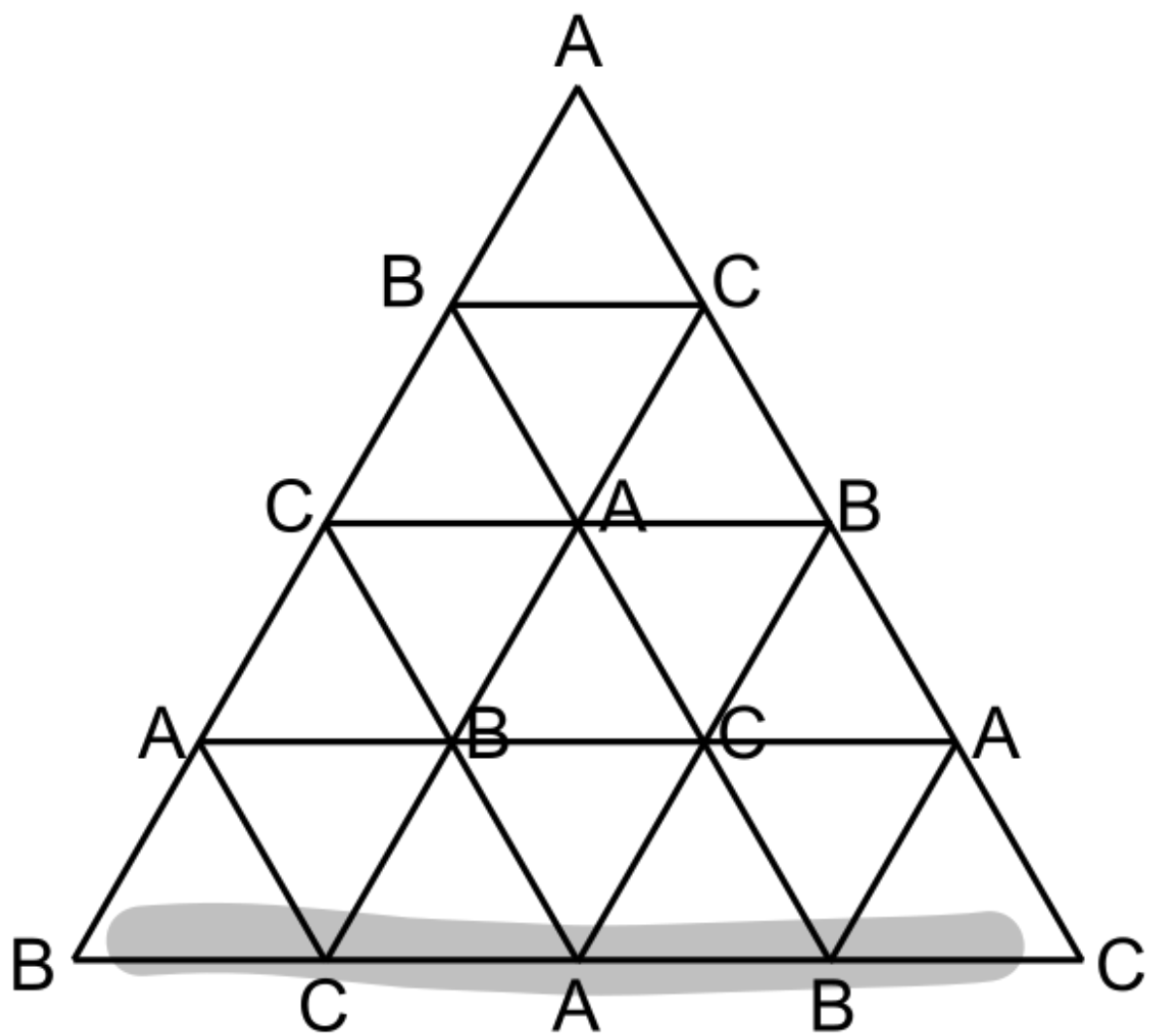

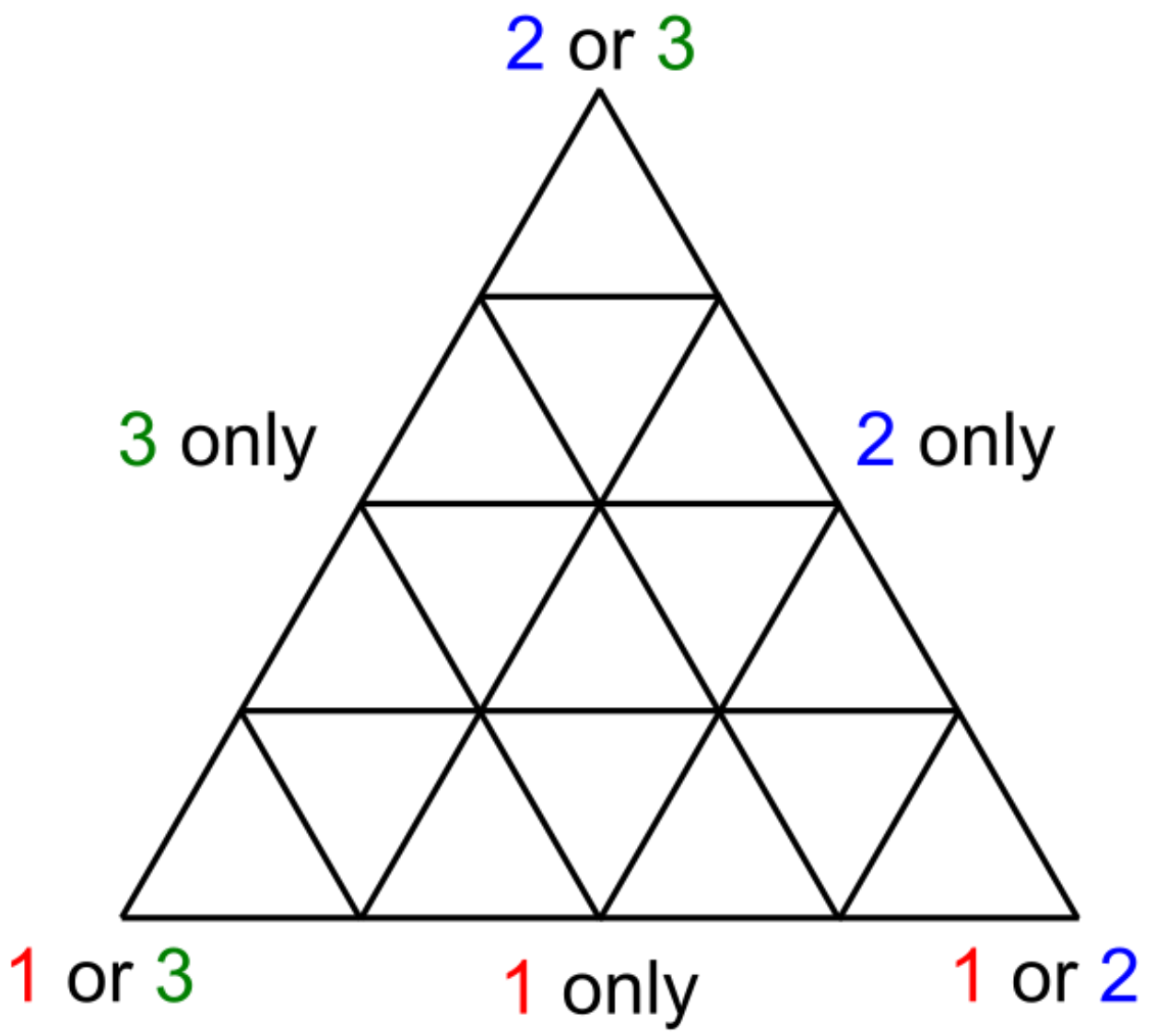
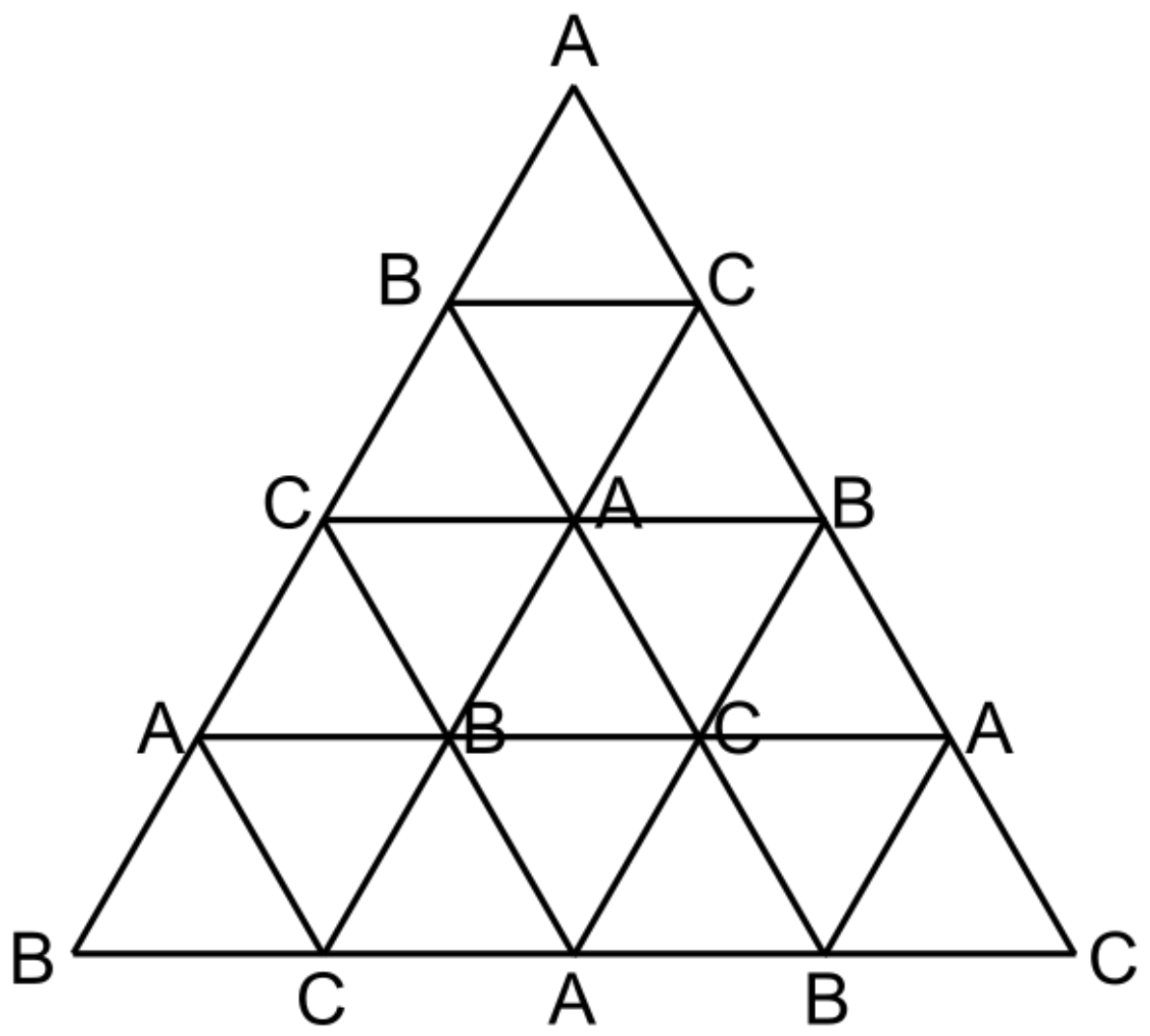

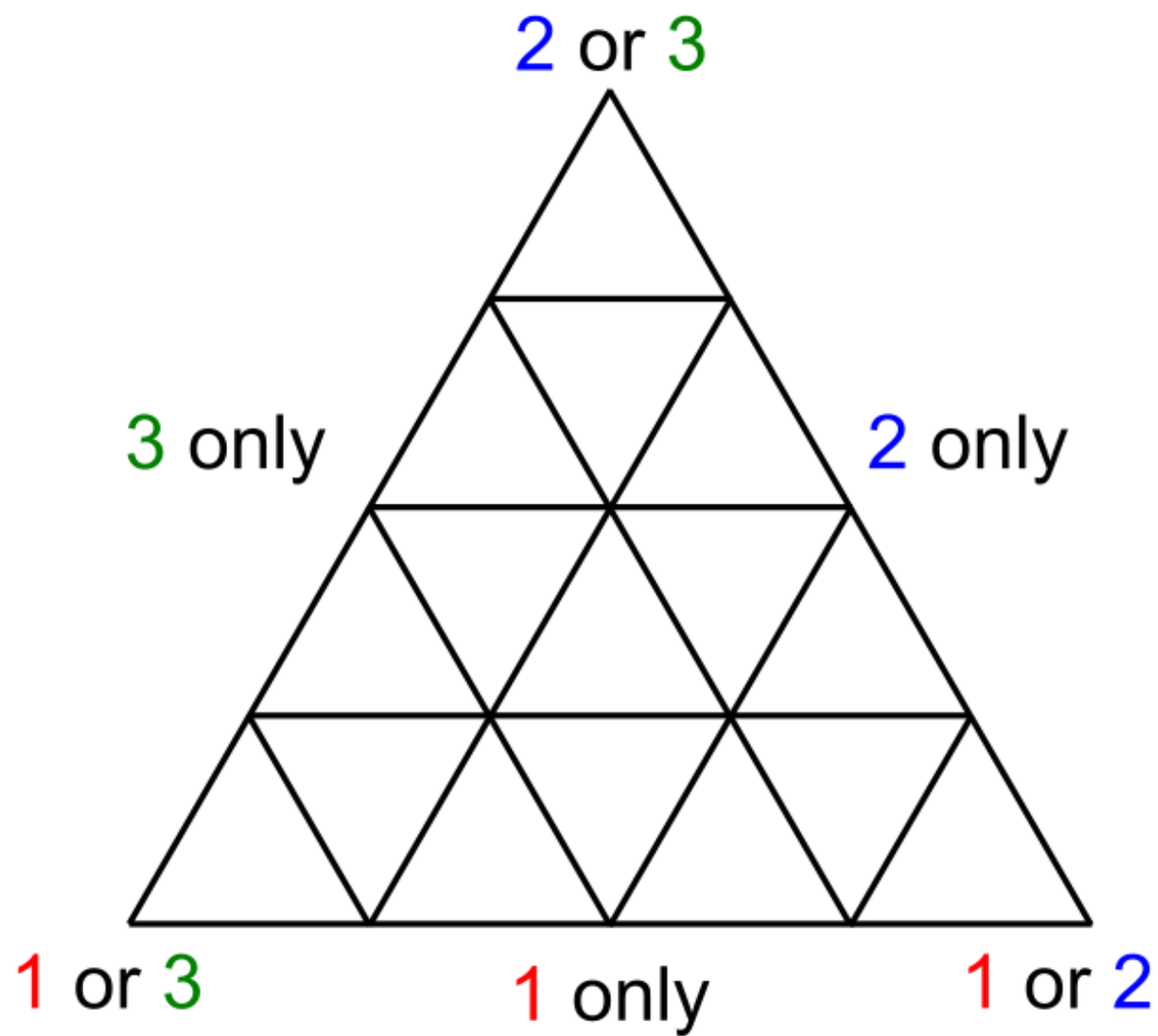

Approach 1
Case analysis

Approach 2
Thinking outside the box

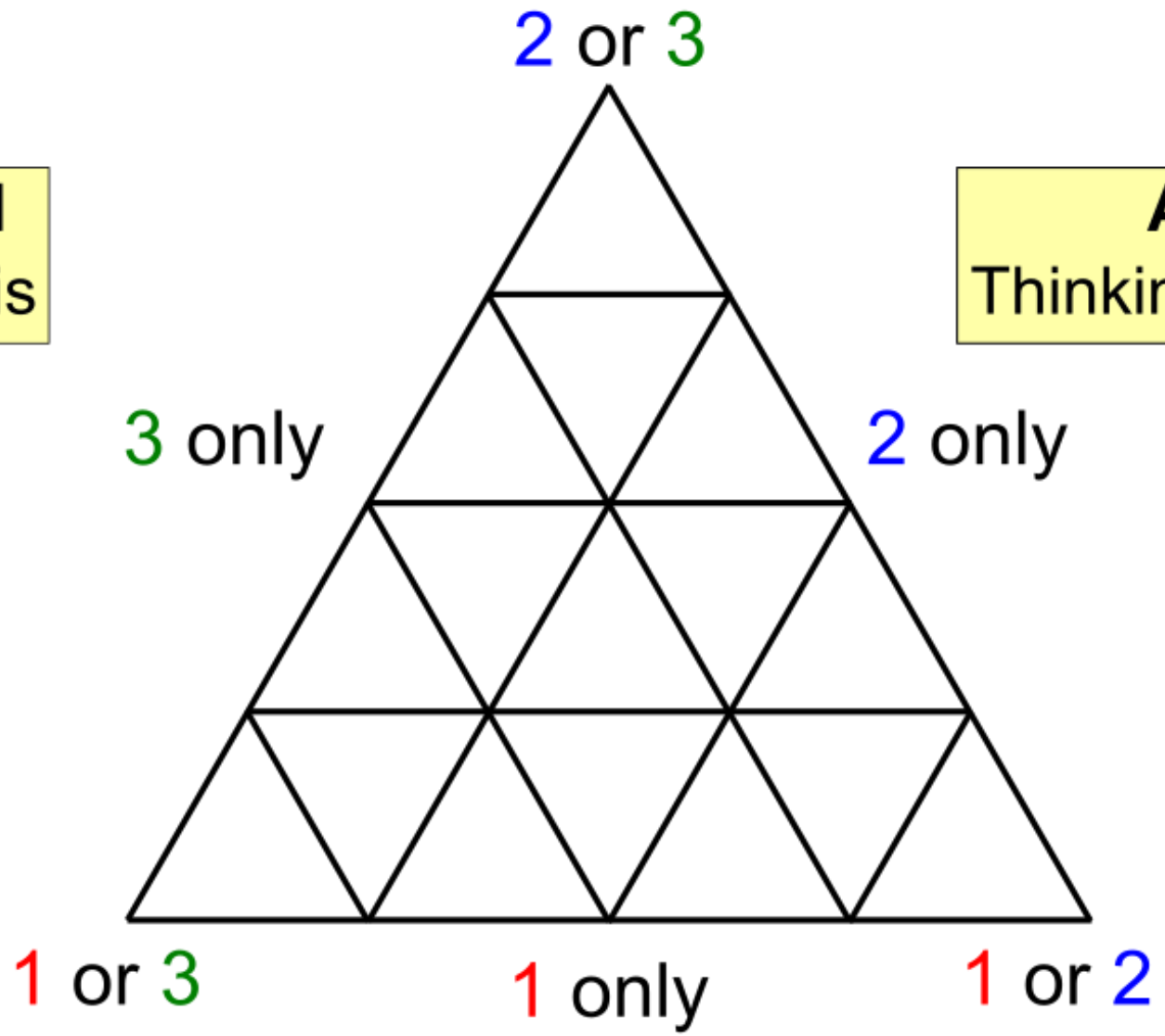

Approach 1
Case analysis

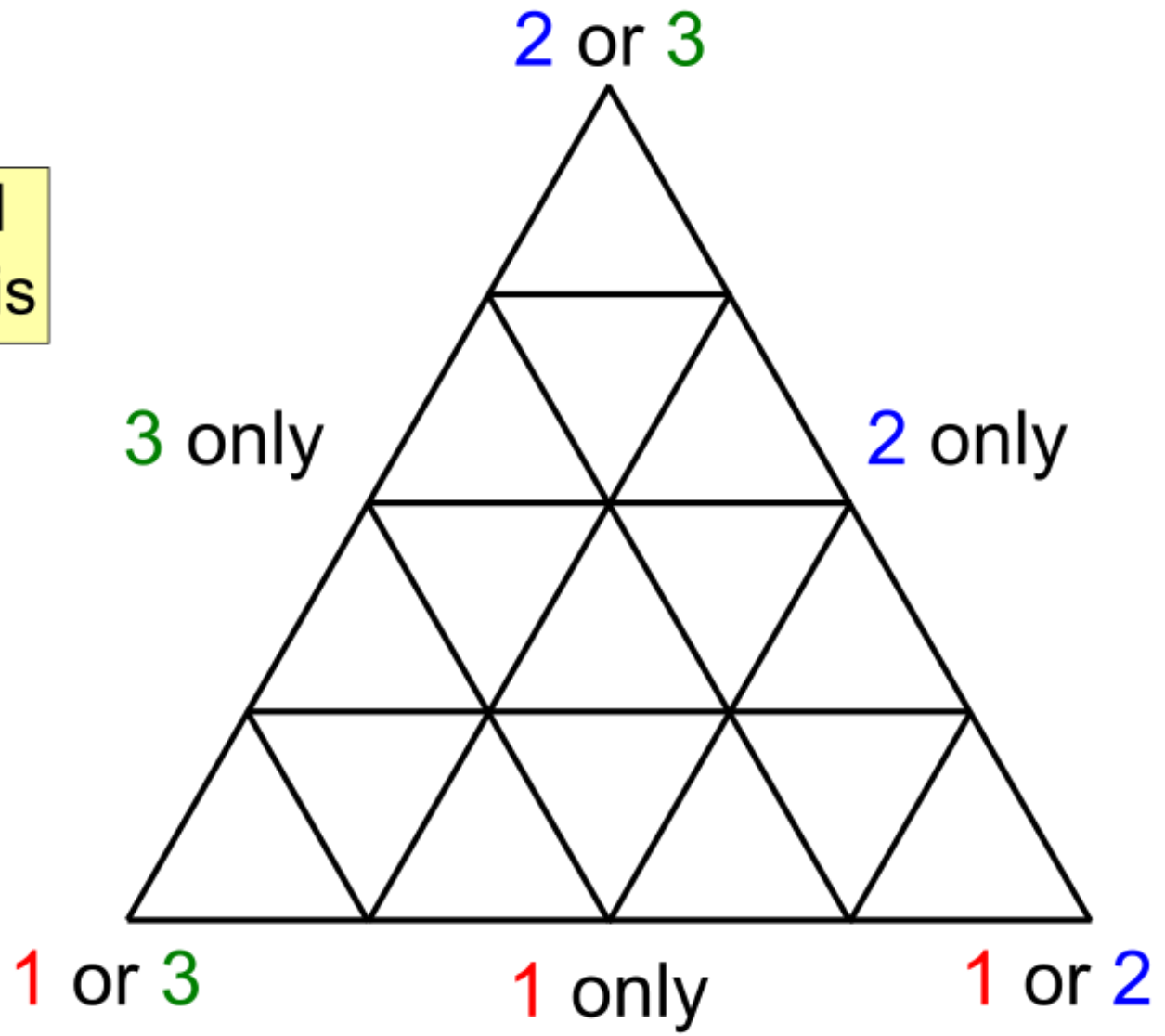

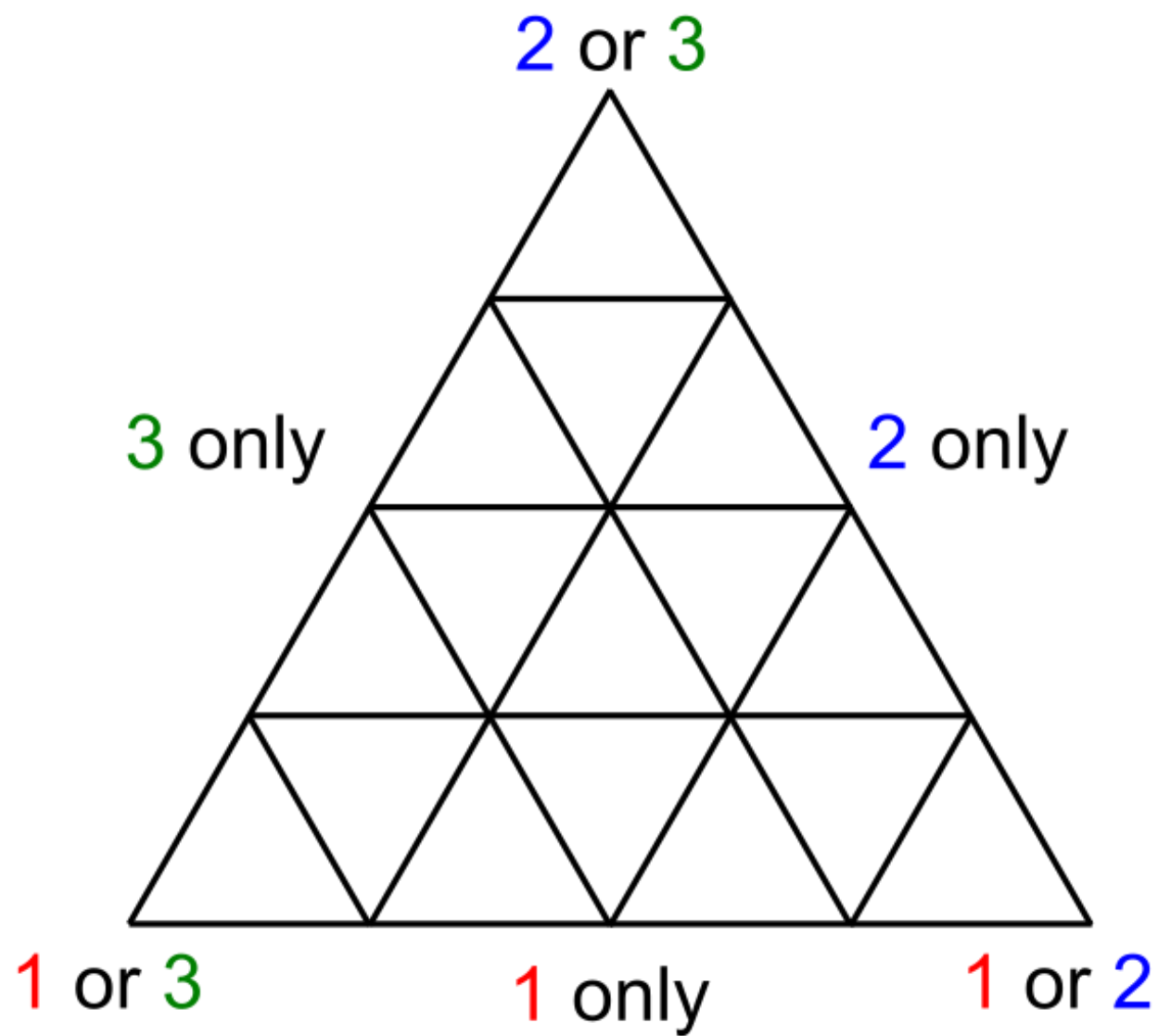

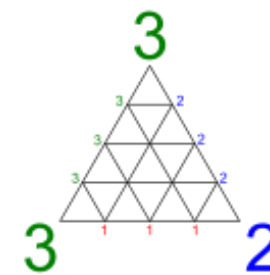
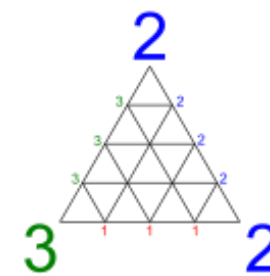
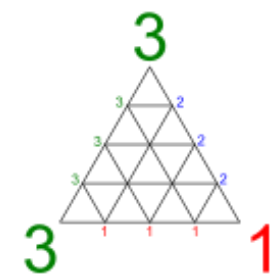
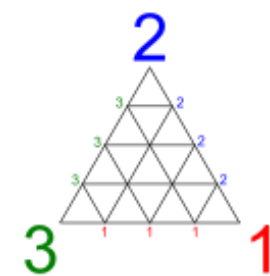
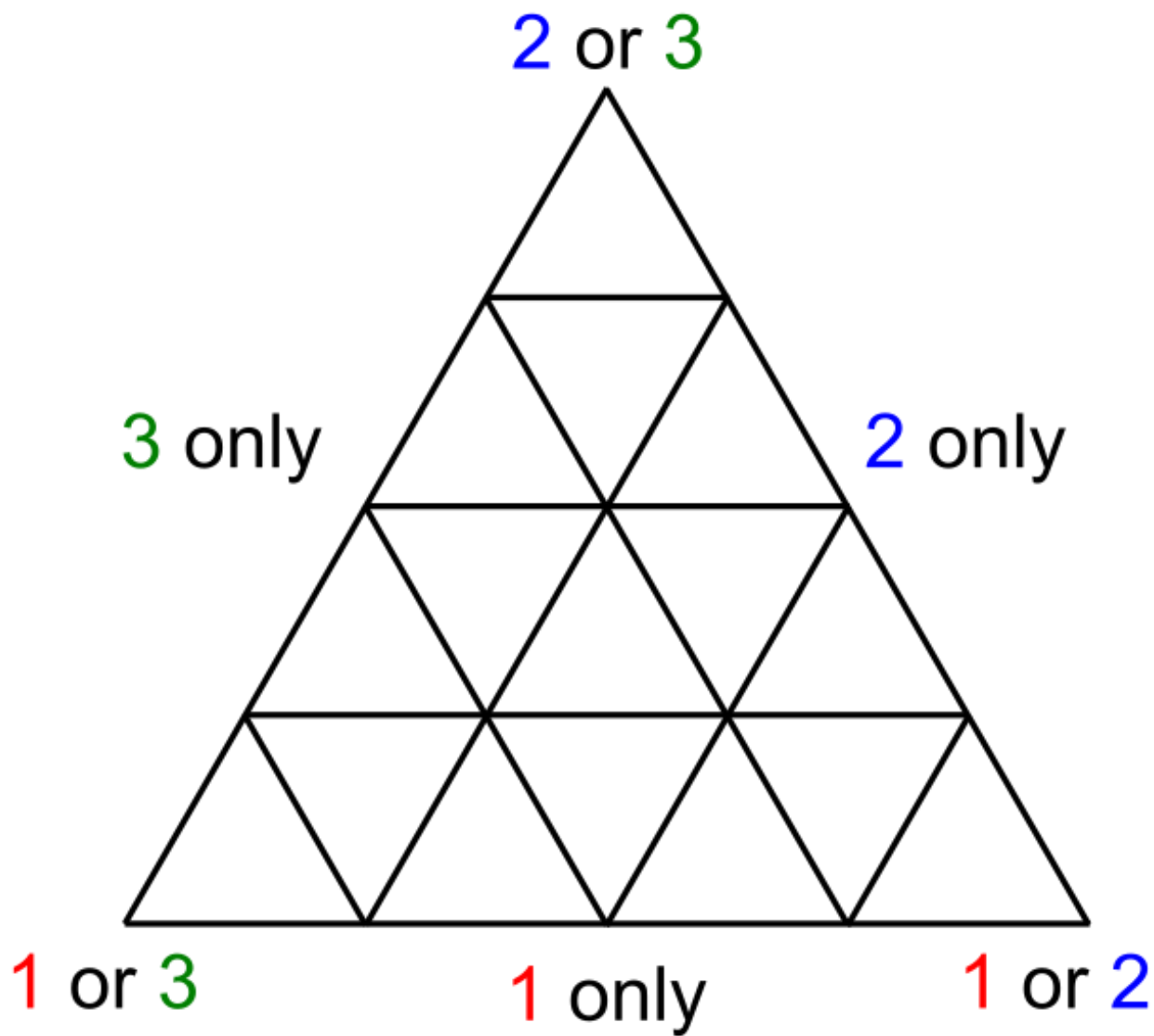
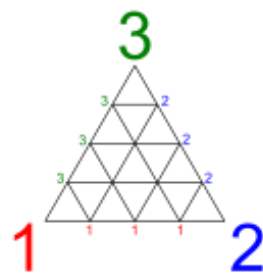
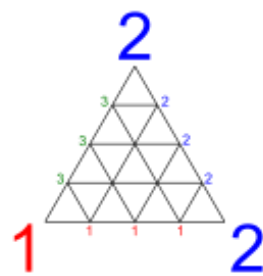
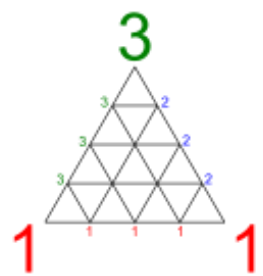
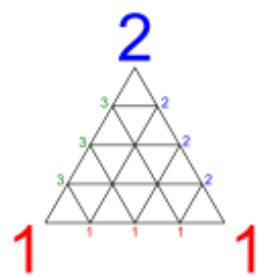

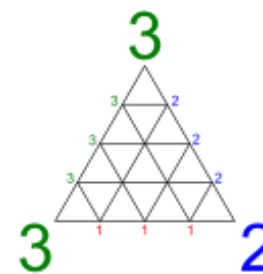
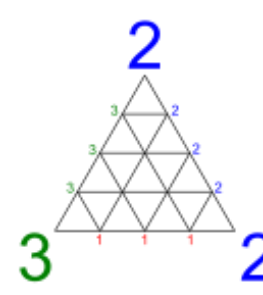
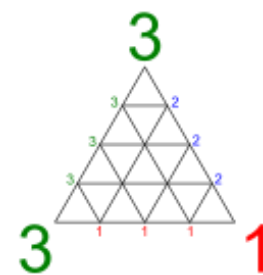
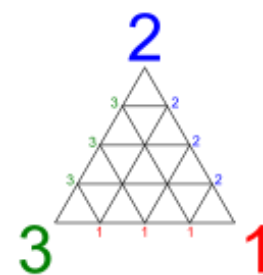
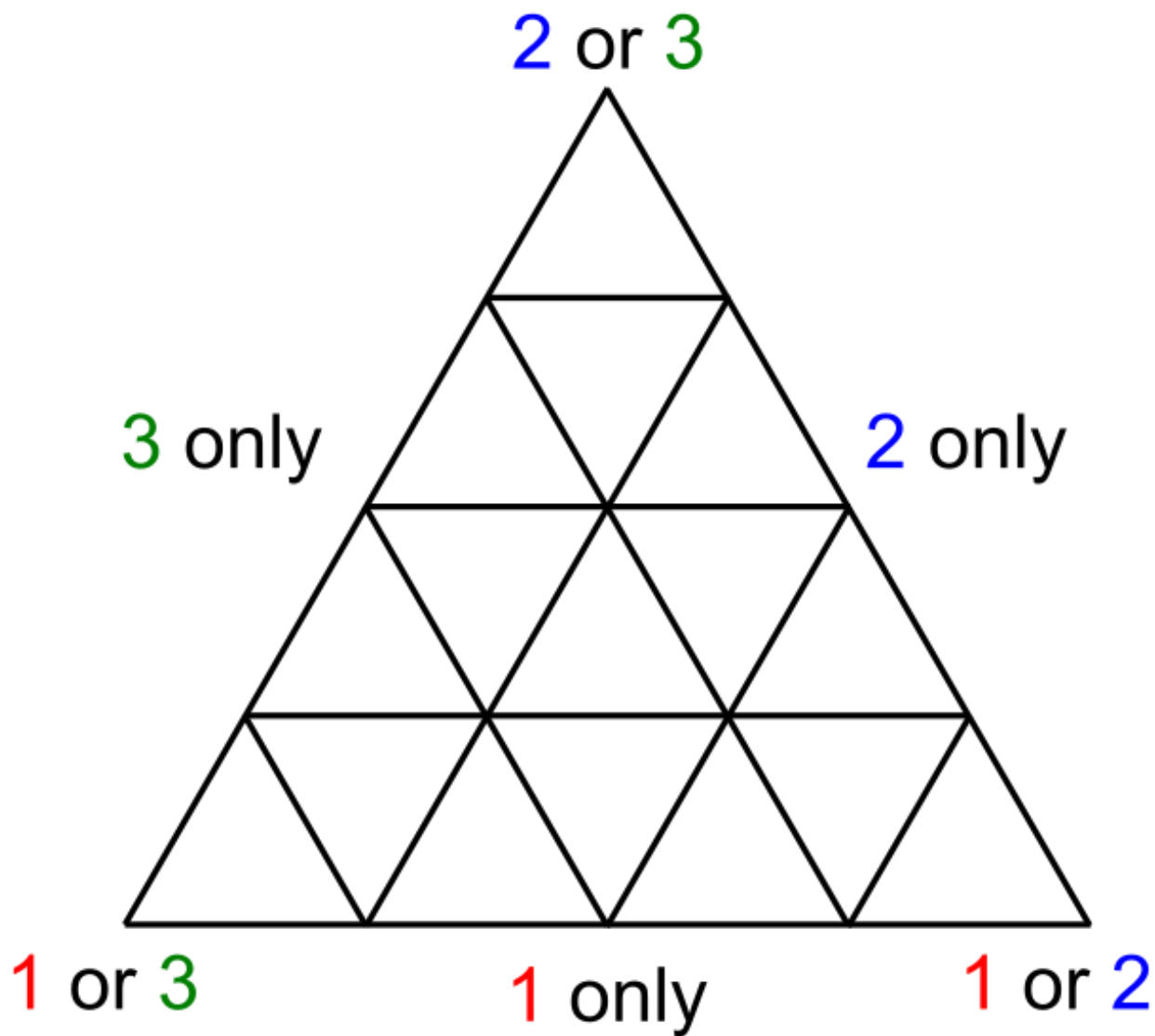
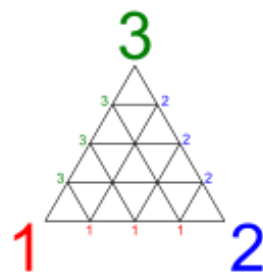
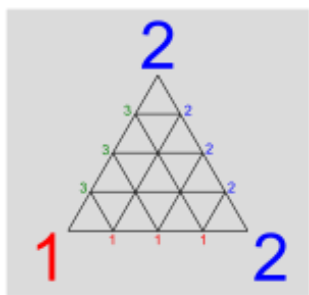
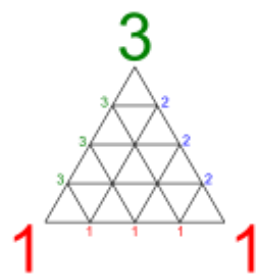
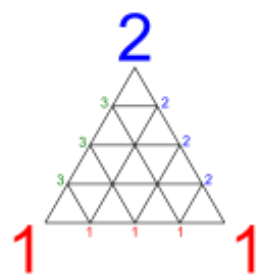

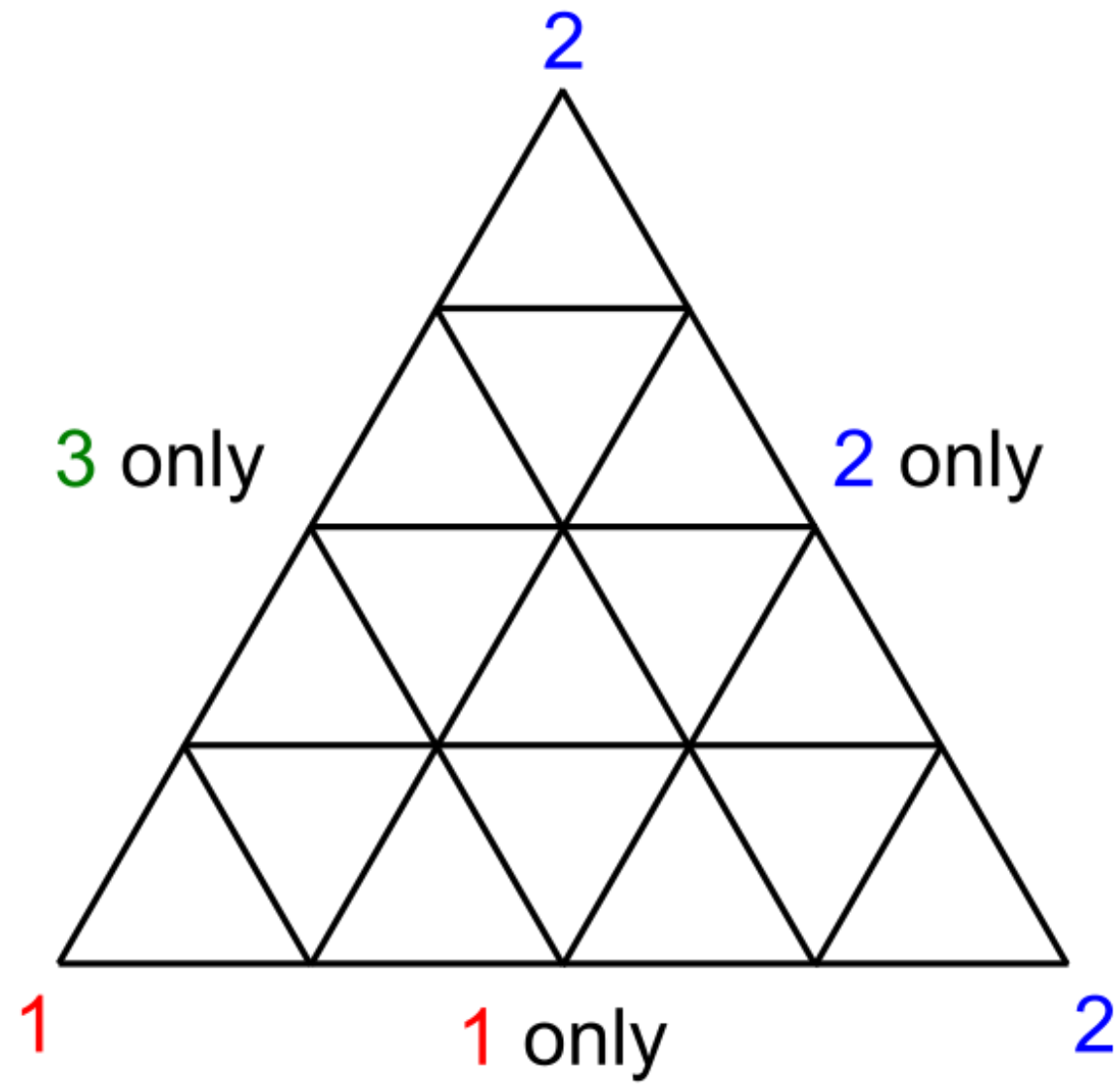

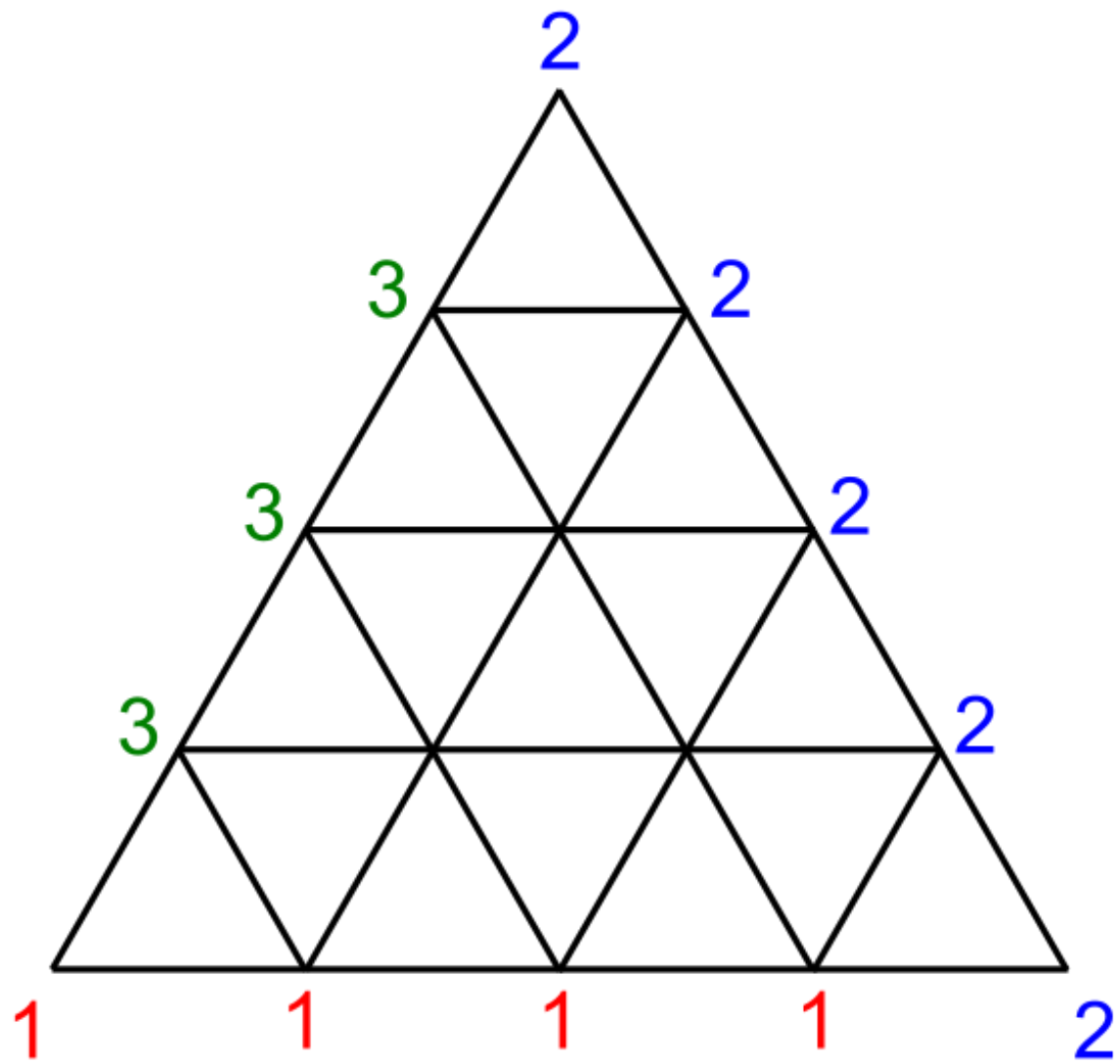

Not a Sperner labeling

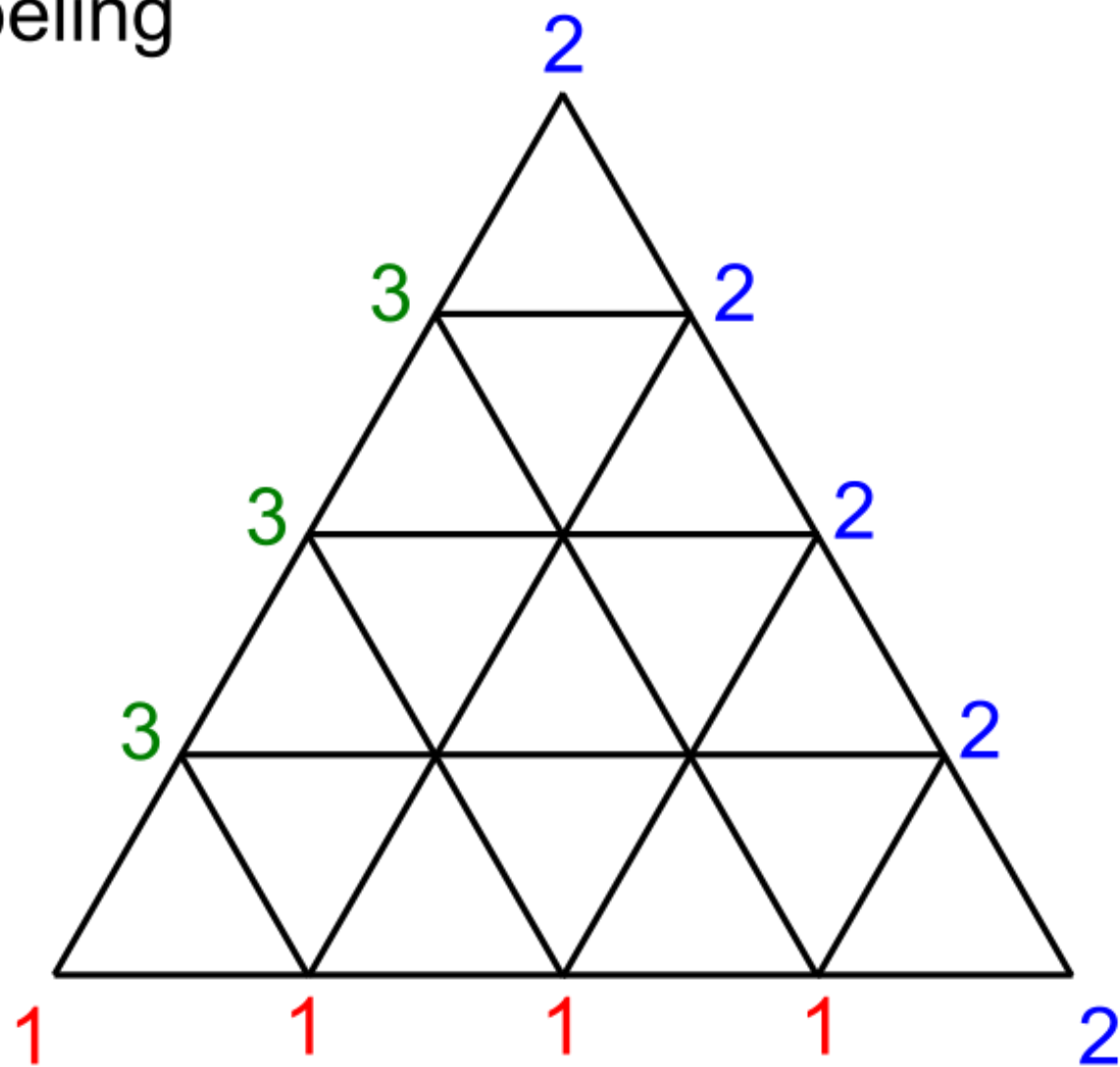

Not a Sperner labeling

But "proof by walking"
still applies!

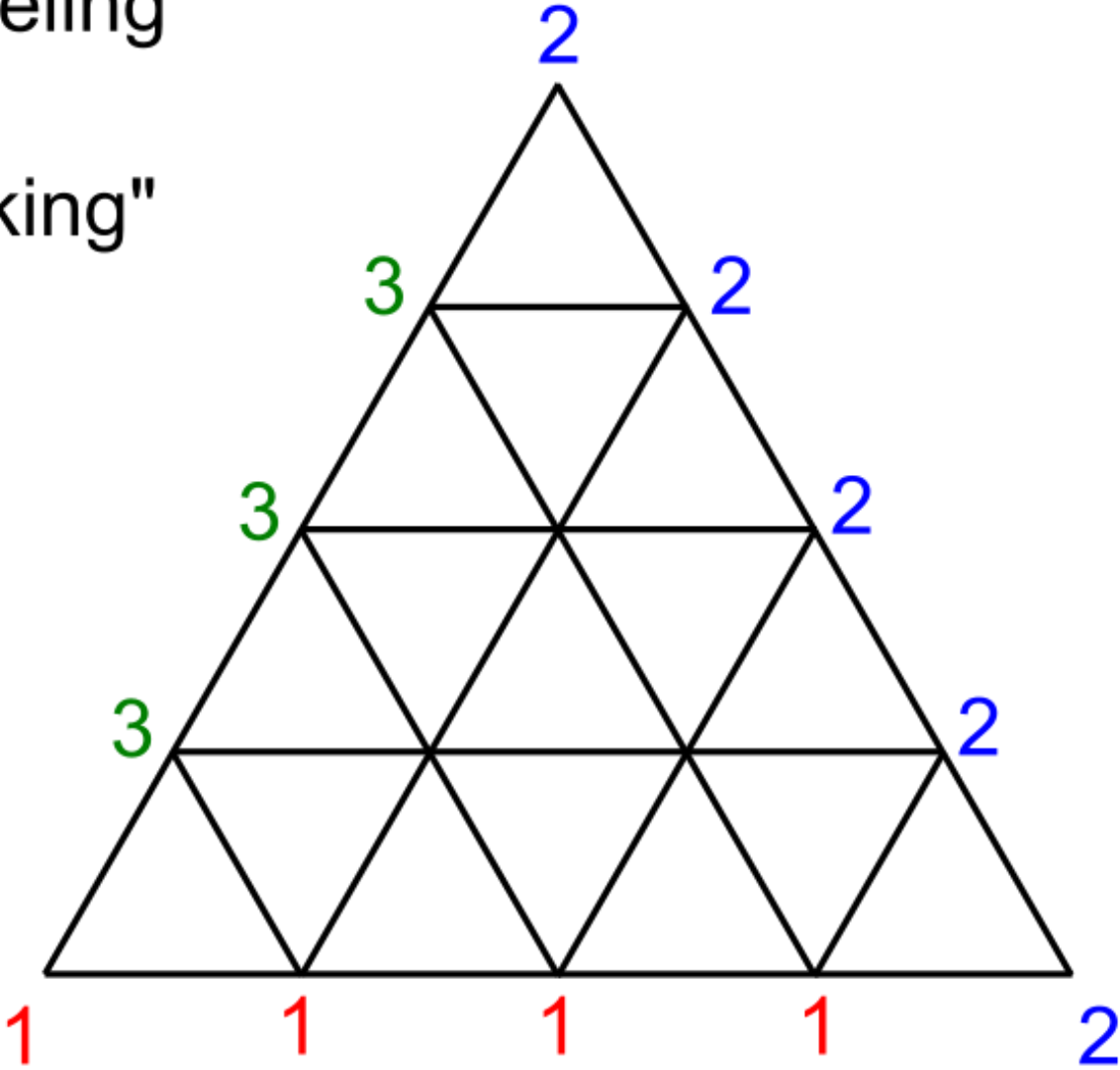

Not a Sperner labeling

But "proof by walking"
still applies!

Why?

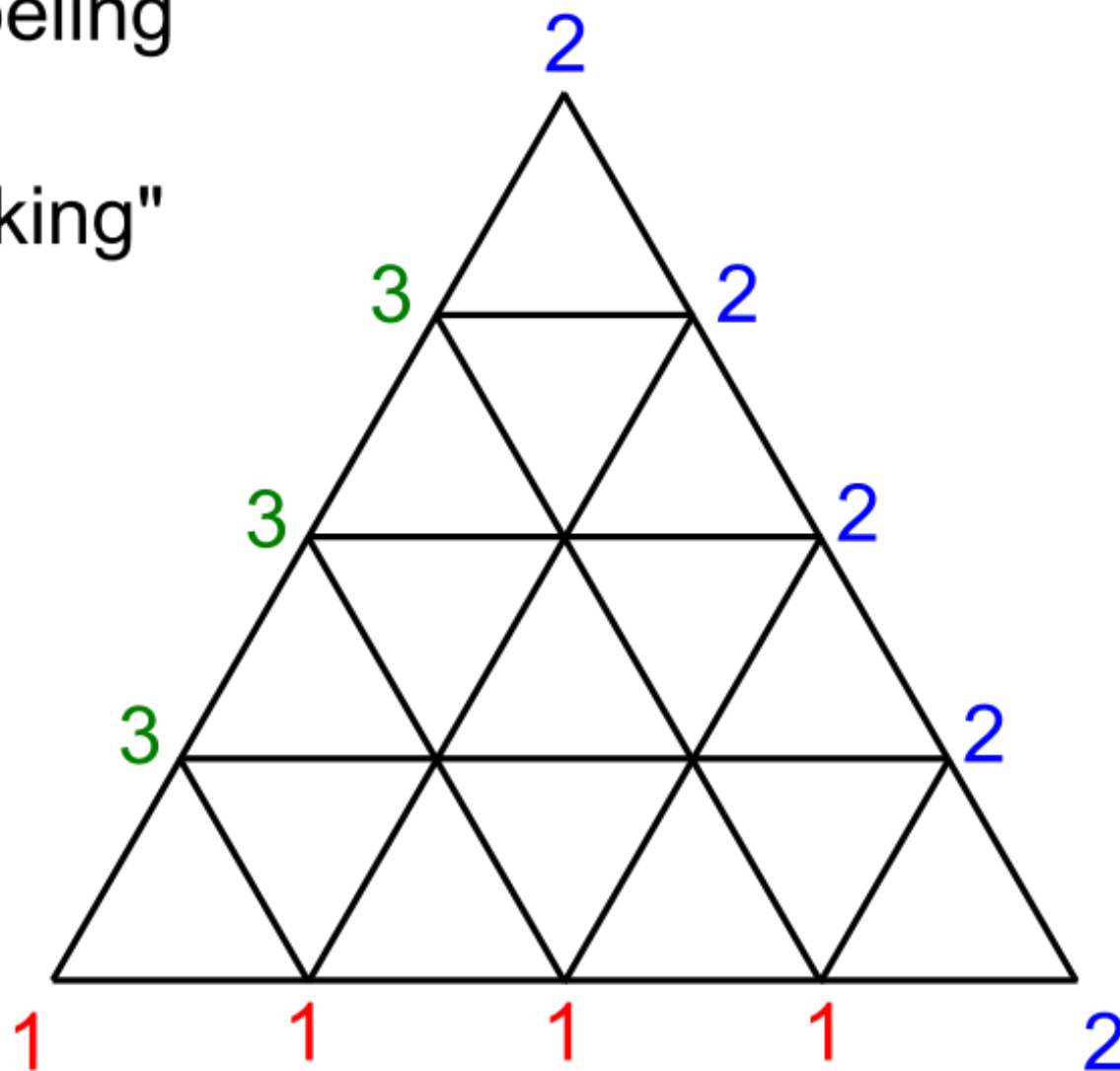

Not a Sperner labeling

But "proof by walking"
still applies!

Why?

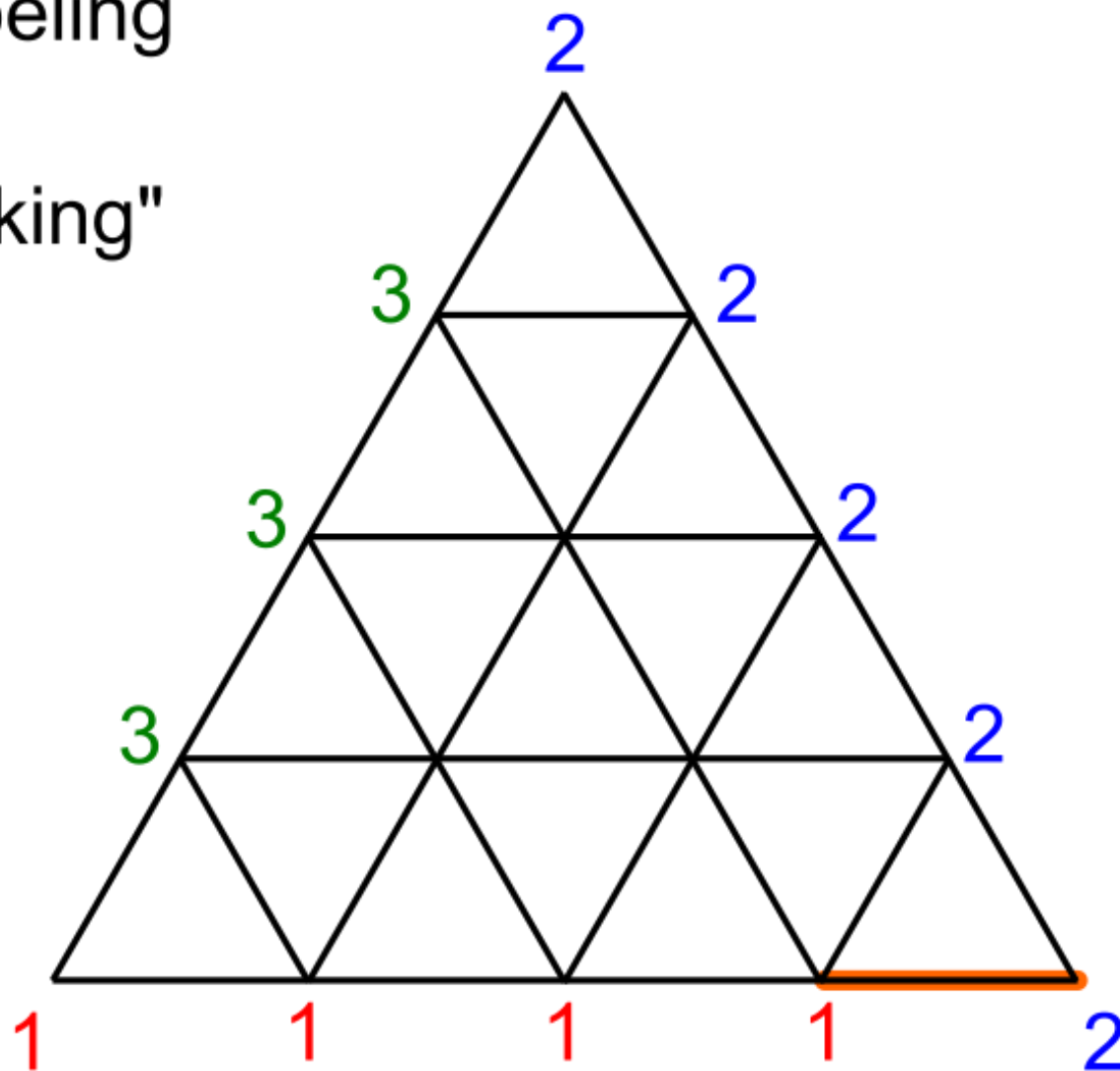

Not a Sperner labeling

But "proof by walking"
still applies!

Why?

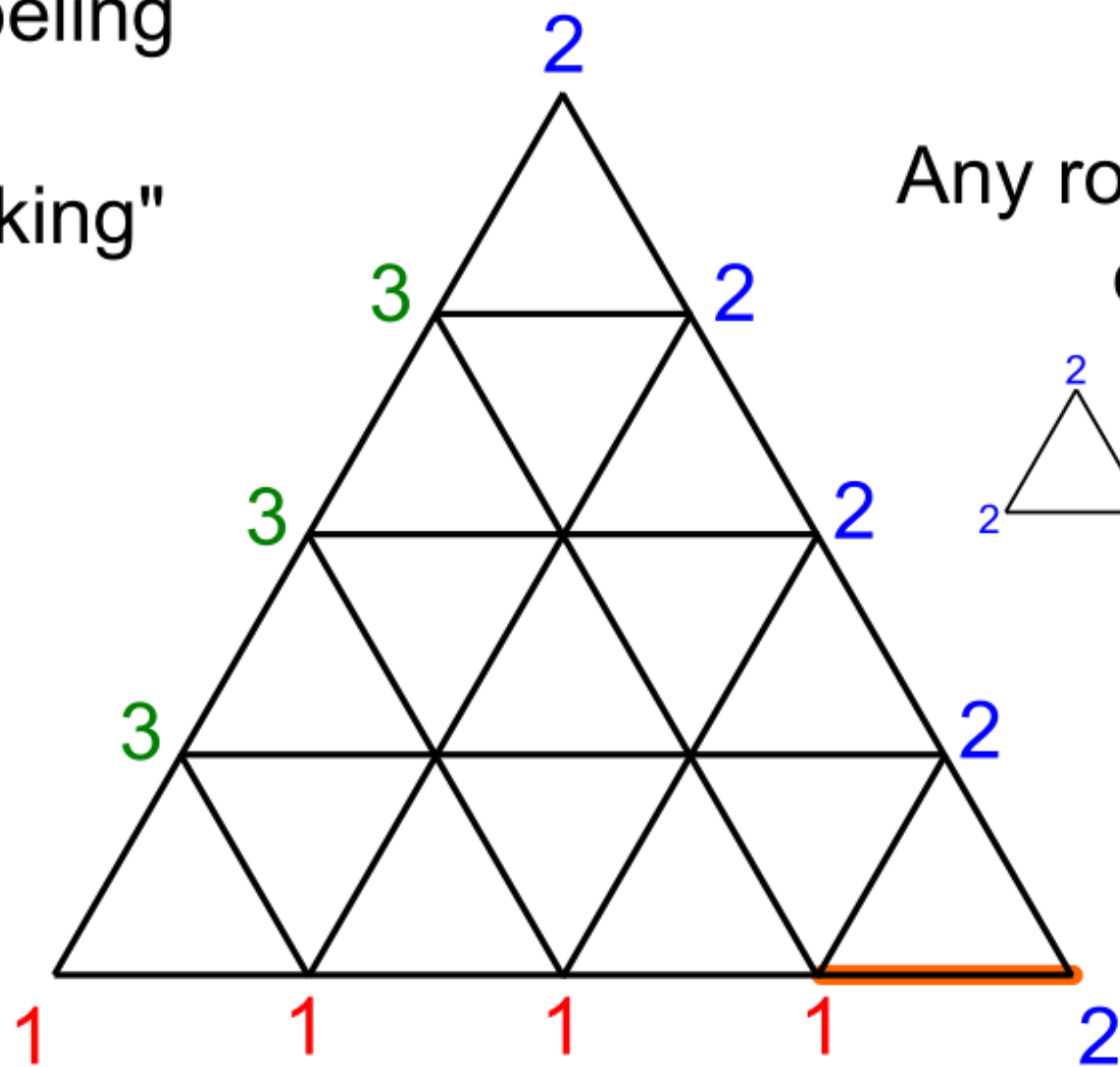

Any room has zero, one,
or two doors

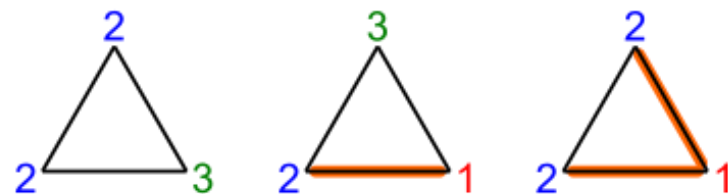

Not a Sperner labeling

But "proof by walking"
still applies!

Why?

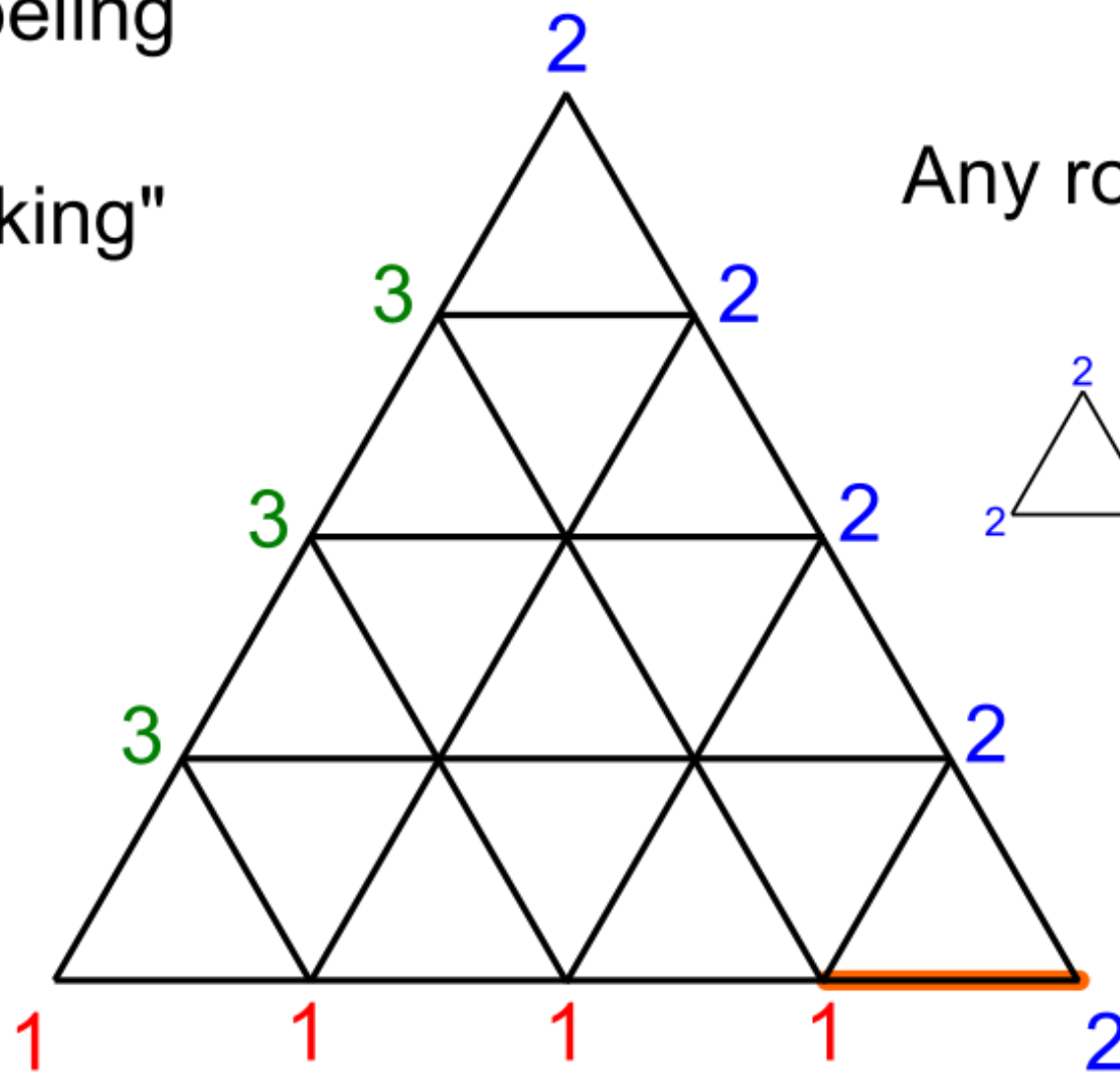

Property of triangles!



Any room has zero, one,
or two doors

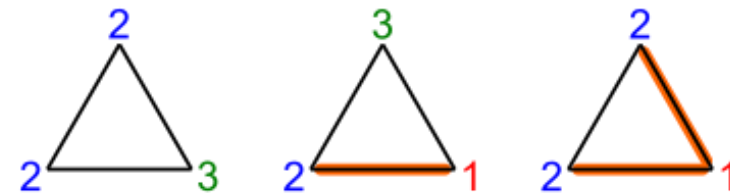

Not a Sperner labeling

But "proof by walking"
still applies!

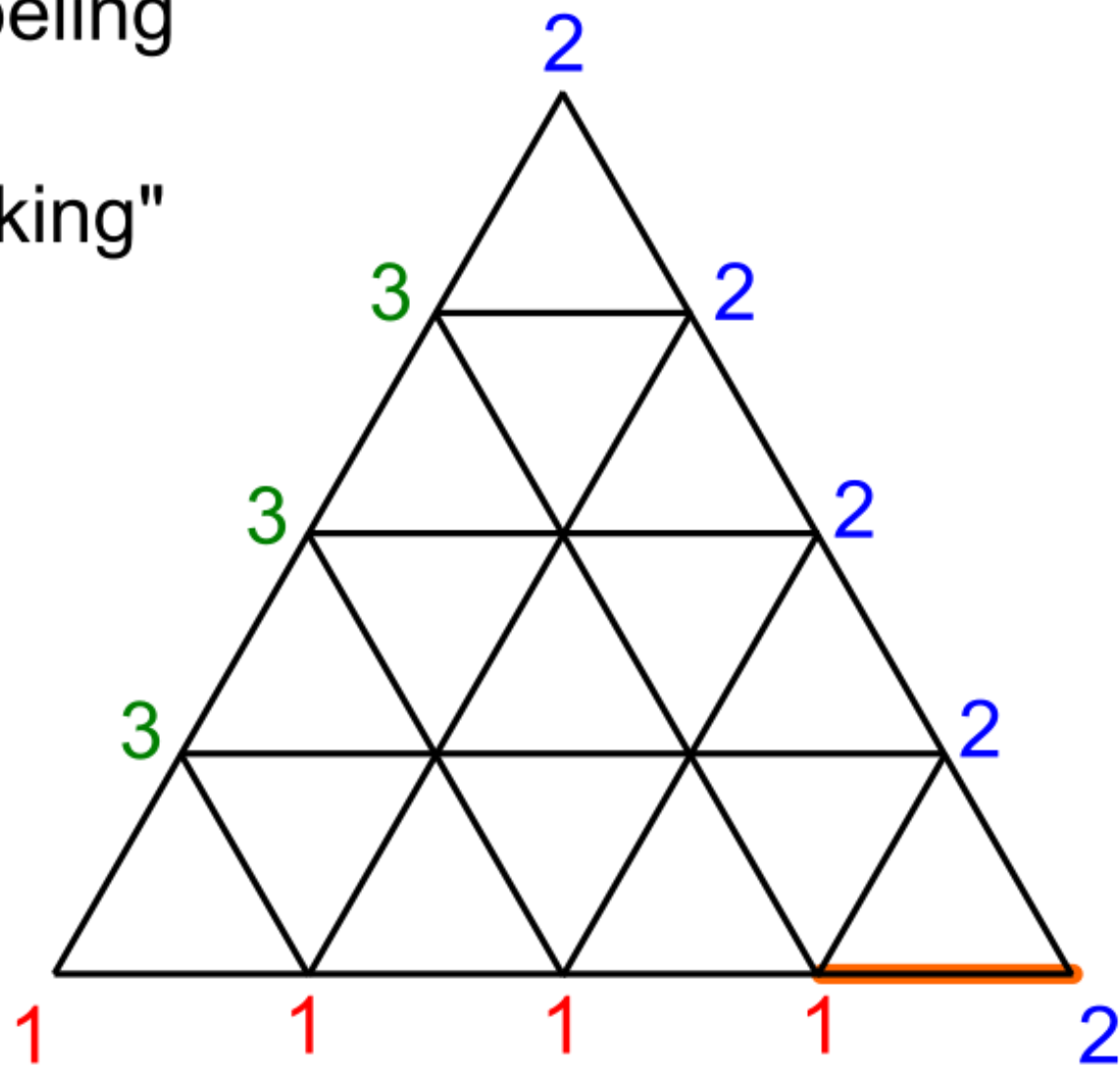

Not a Sperner labeling

Unique door on boundary

But "proof by walking"
still applies!

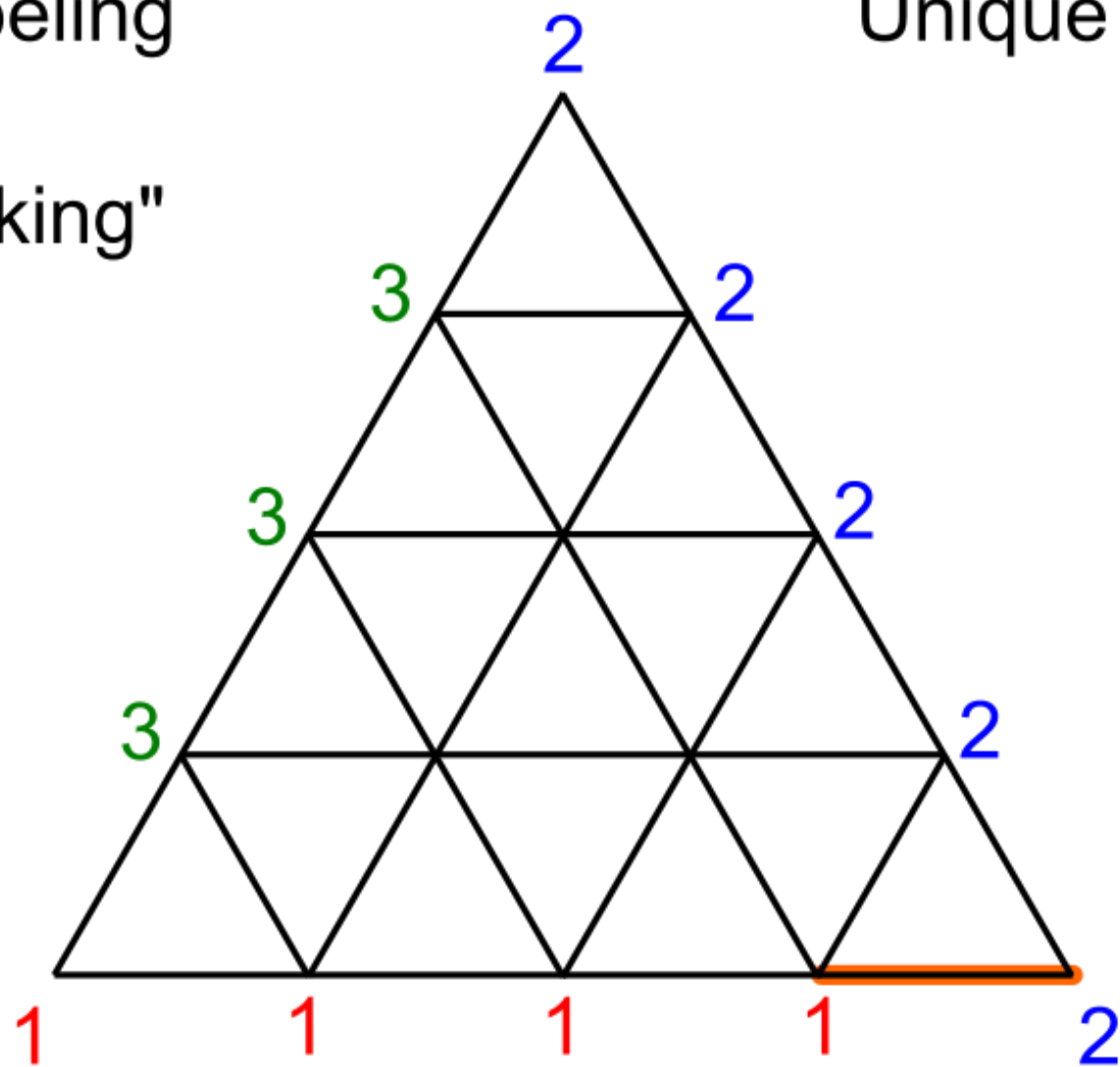

Not a Sperner labeling

But "proof by walking"
still applies!

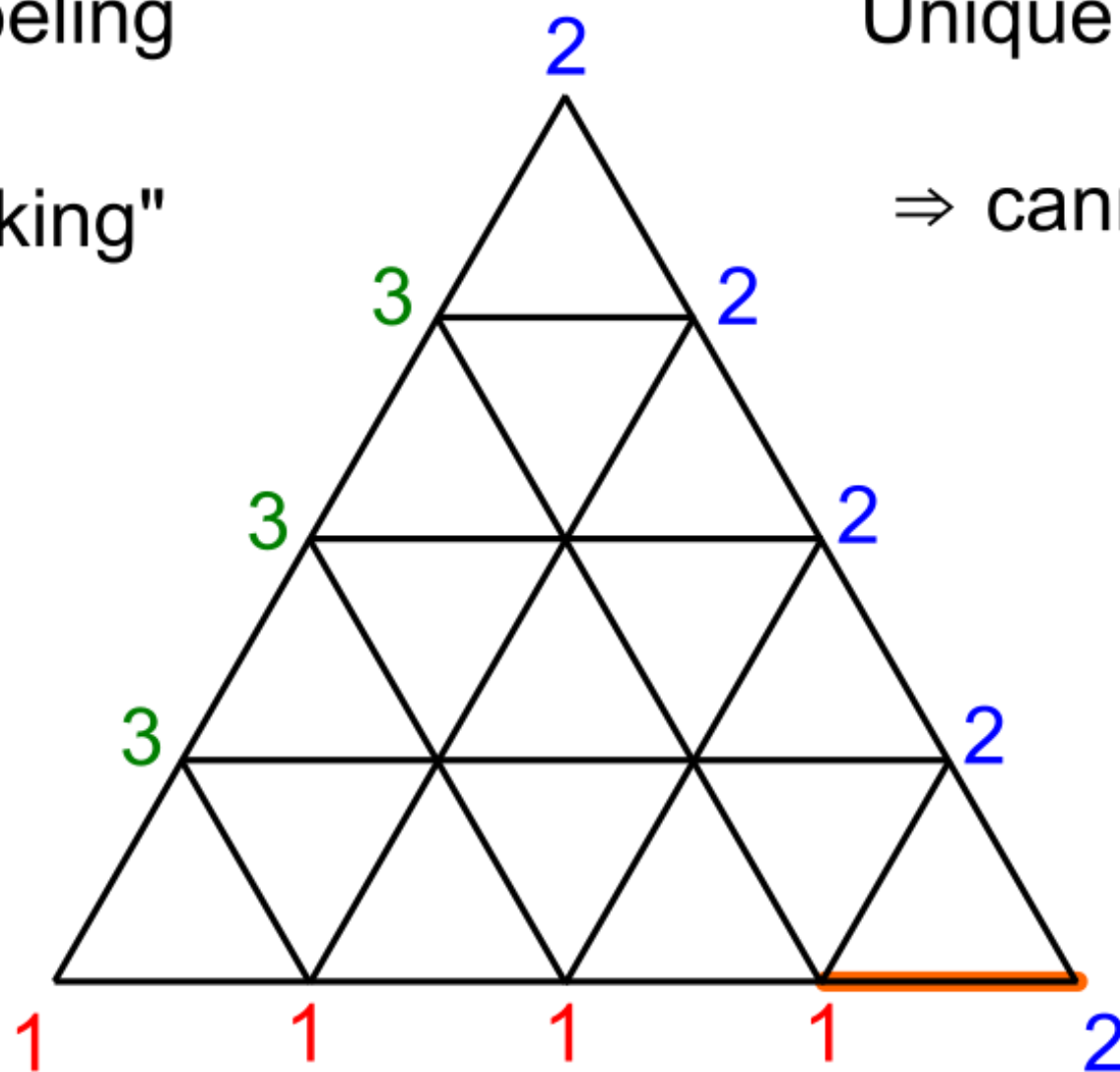

Unique door on boundary

\Rightarrow cannot be thrown out

Not a Sperner labeling

But "proof by walking"
still applies!

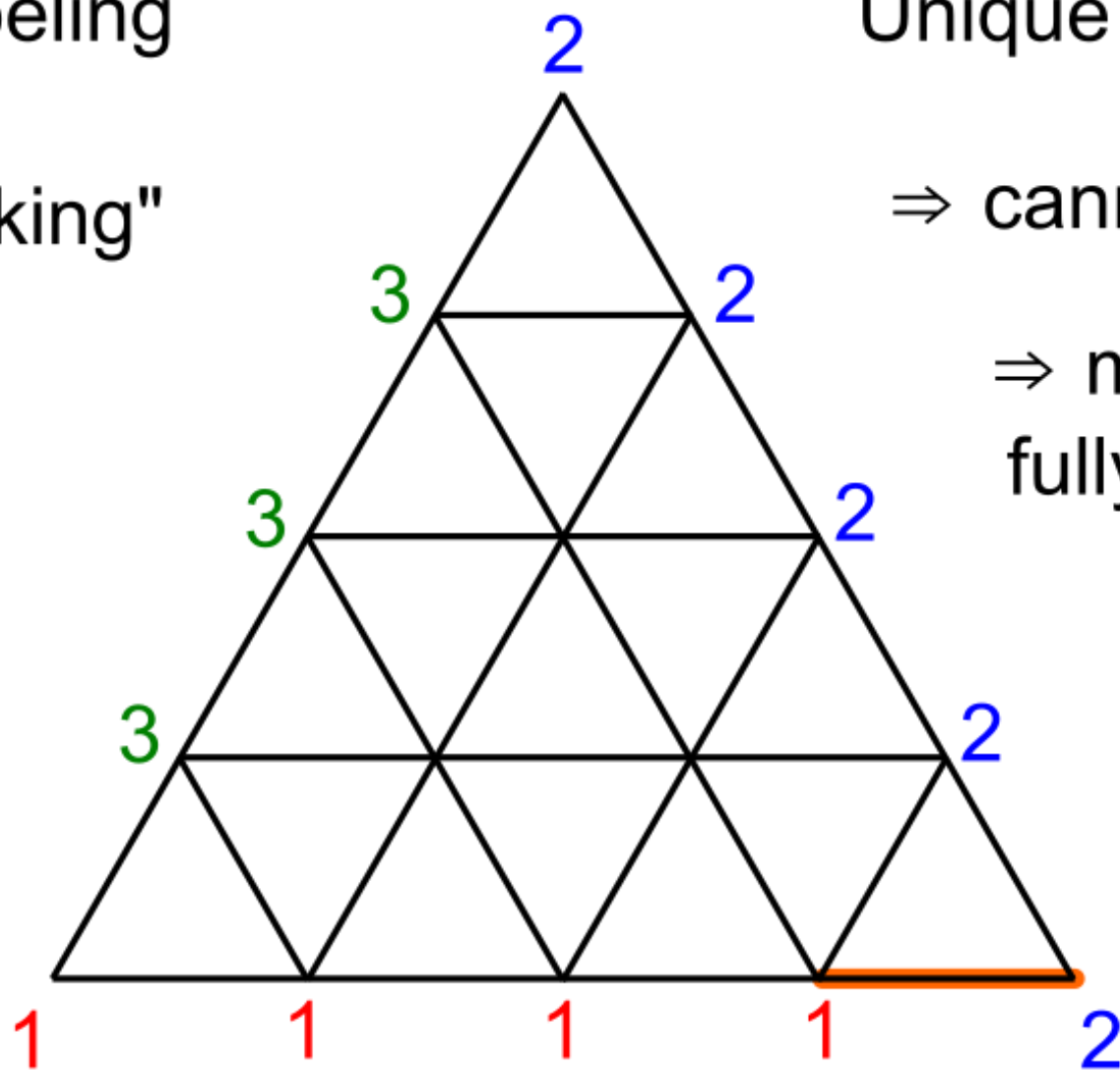

Unique door on boundary

⇒ cannot be thrown out

⇒ must end up in a
fully labeled room!

Not a Sperner labeling

But "proof by walking"
still applies!

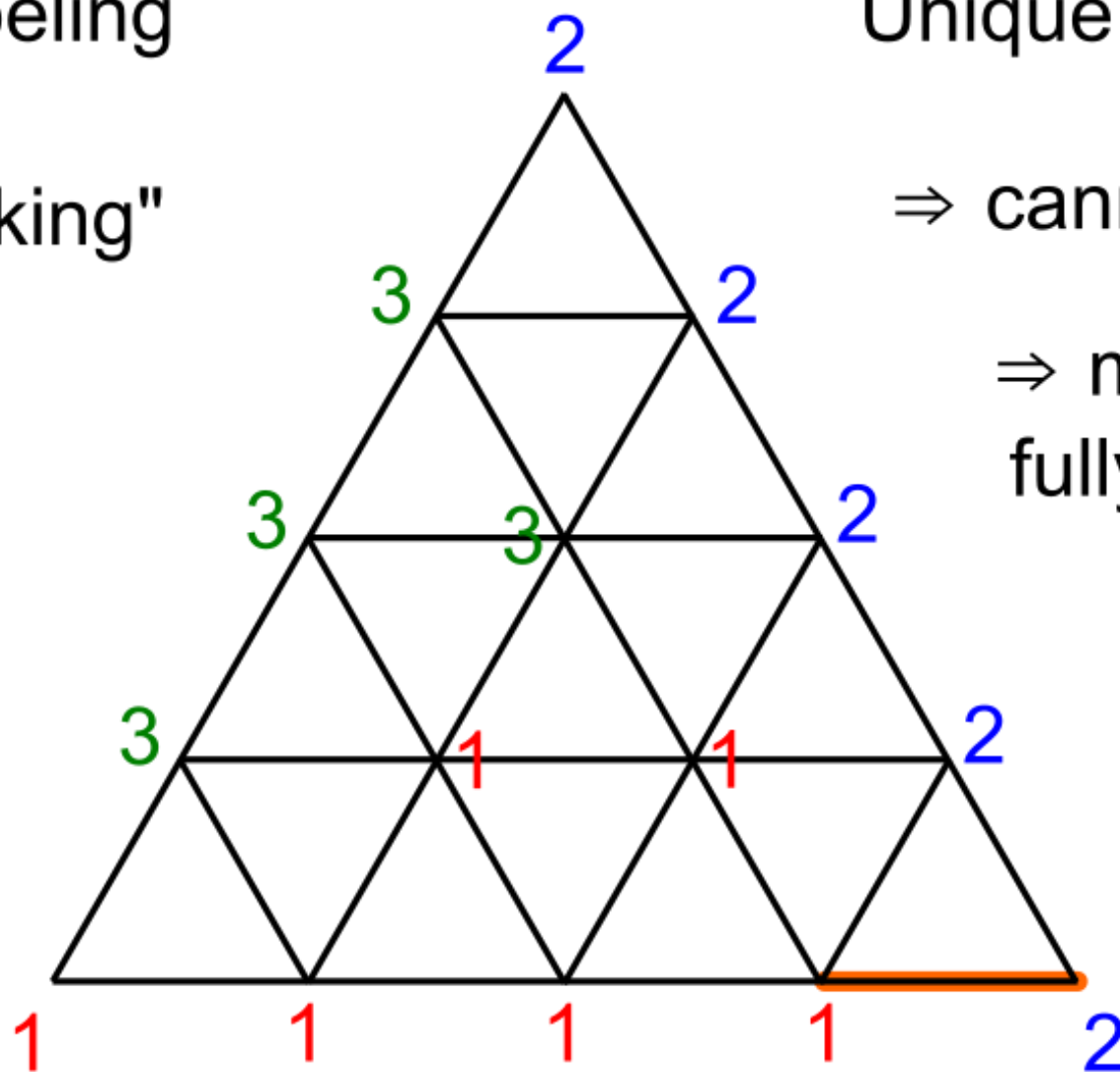

Unique door on boundary

⇒ cannot be thrown out

⇒ must end up in a
fully labeled room!

Not a Sperner labeling

But "proof by walking"
still applies!

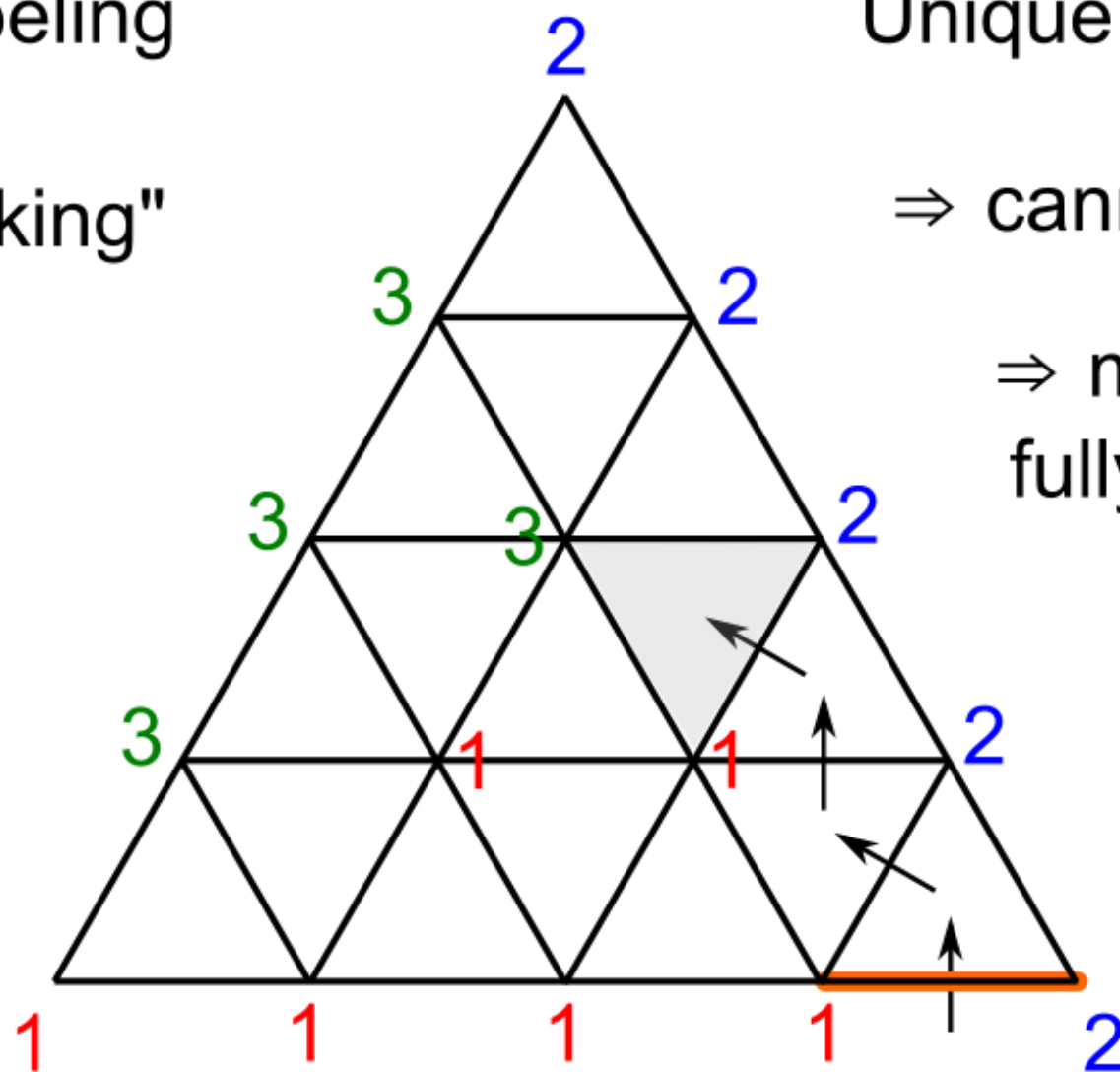

Unique door on boundary

⇒ cannot be thrown out

⇒ must end up in a
fully labeled room!

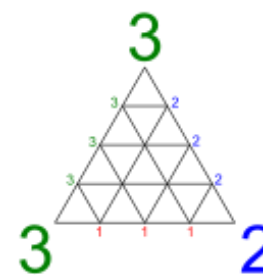
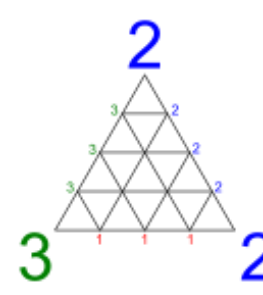
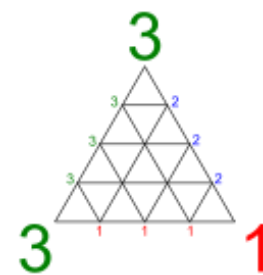
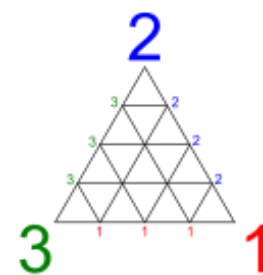
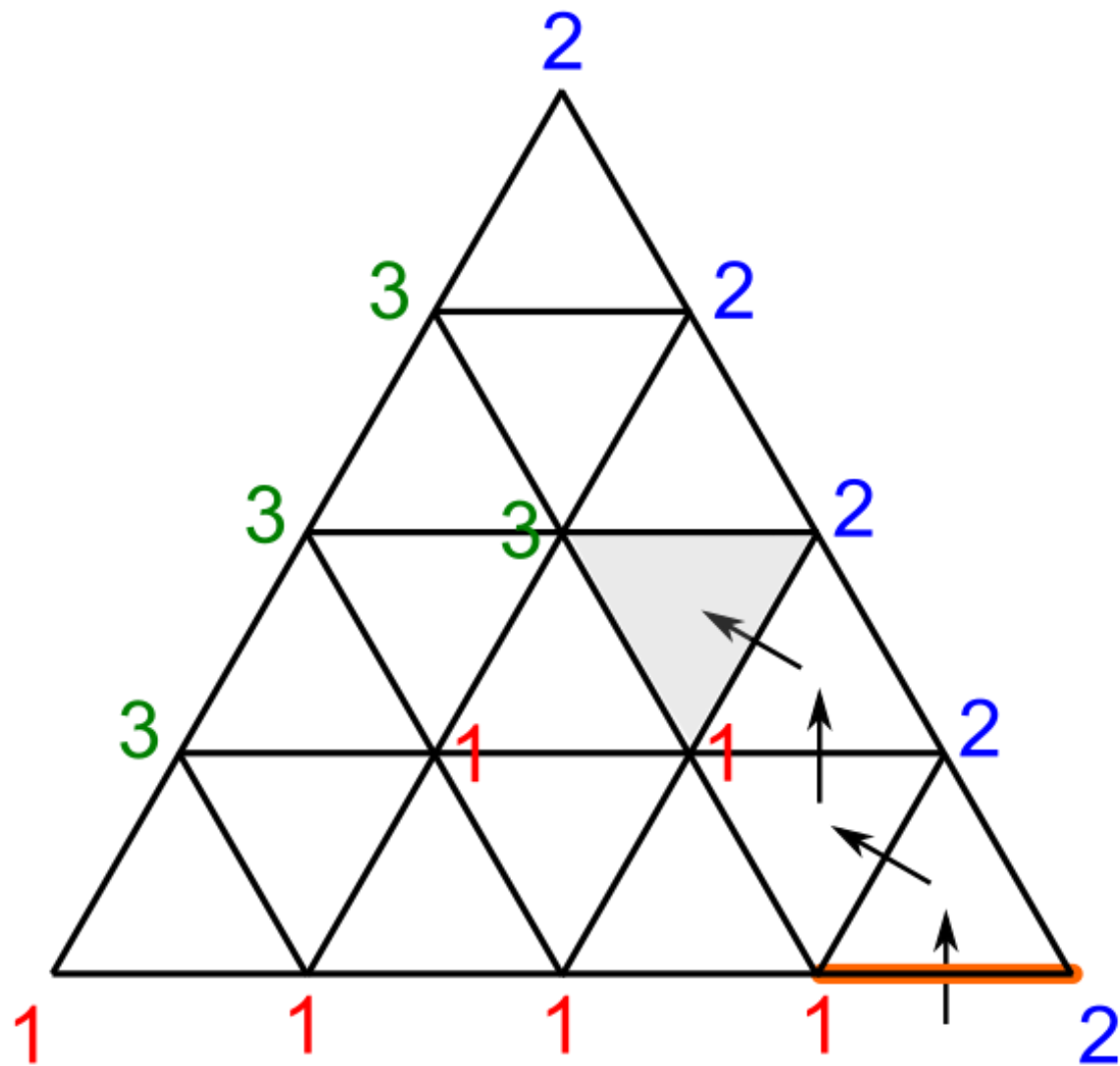
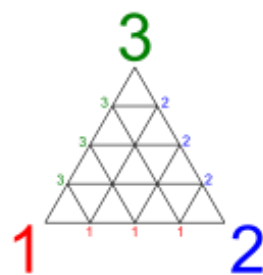
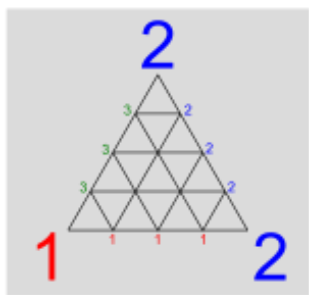
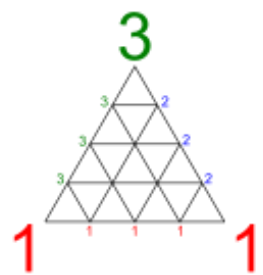
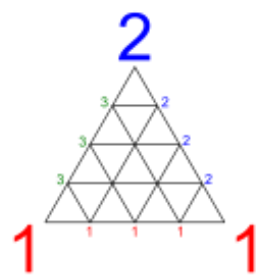

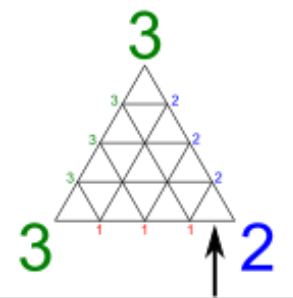
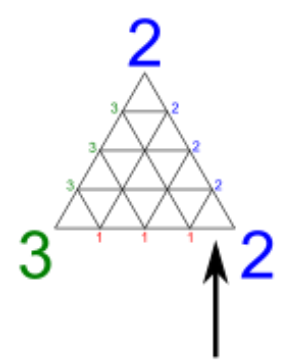
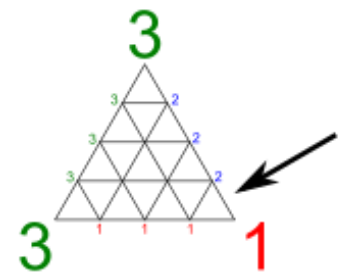
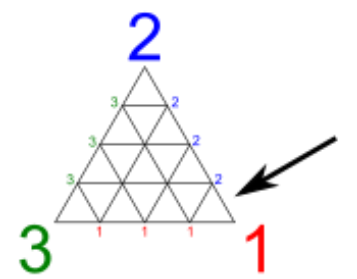
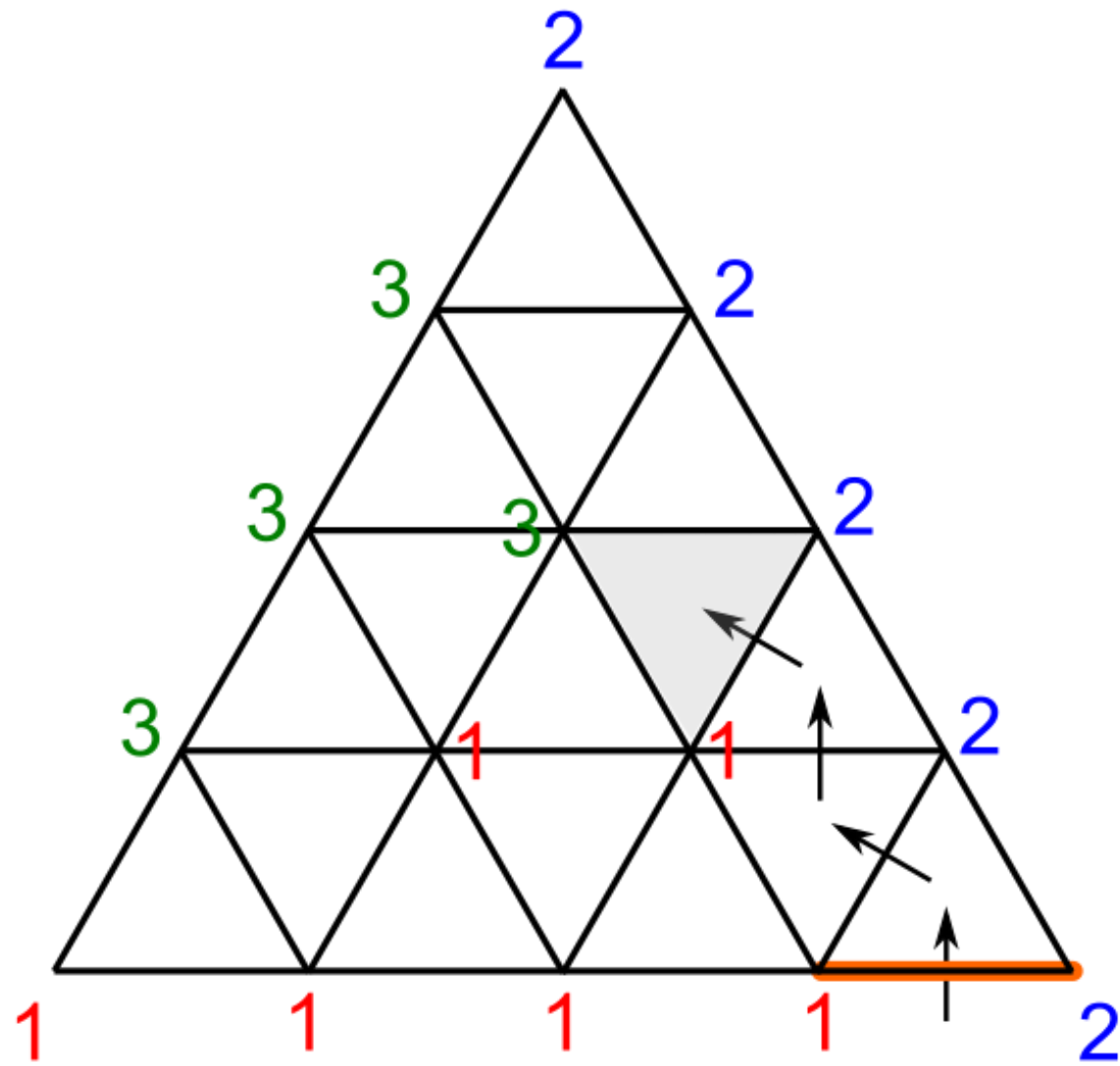
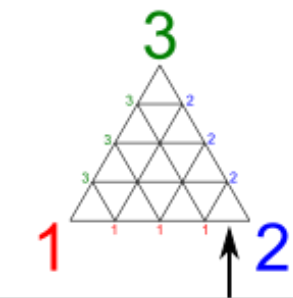
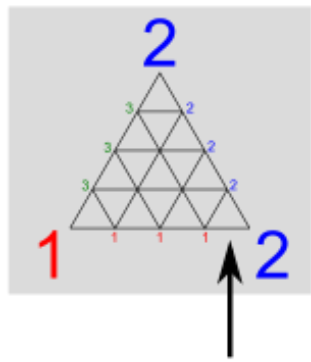
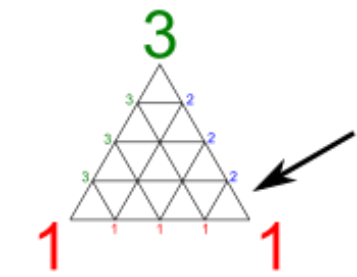
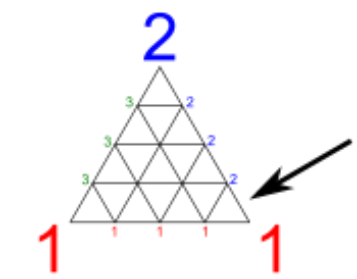

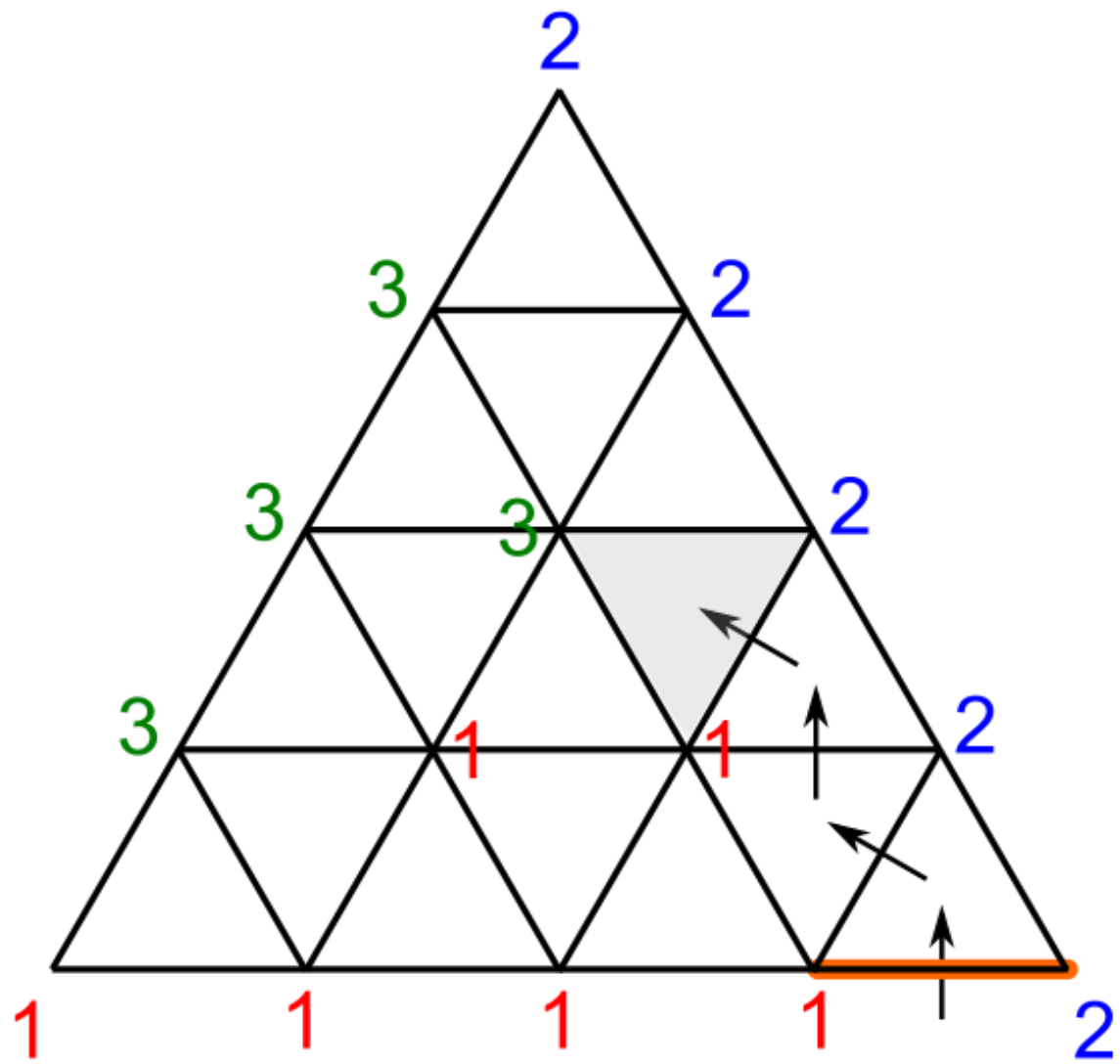

Fully labeled room \Rightarrow

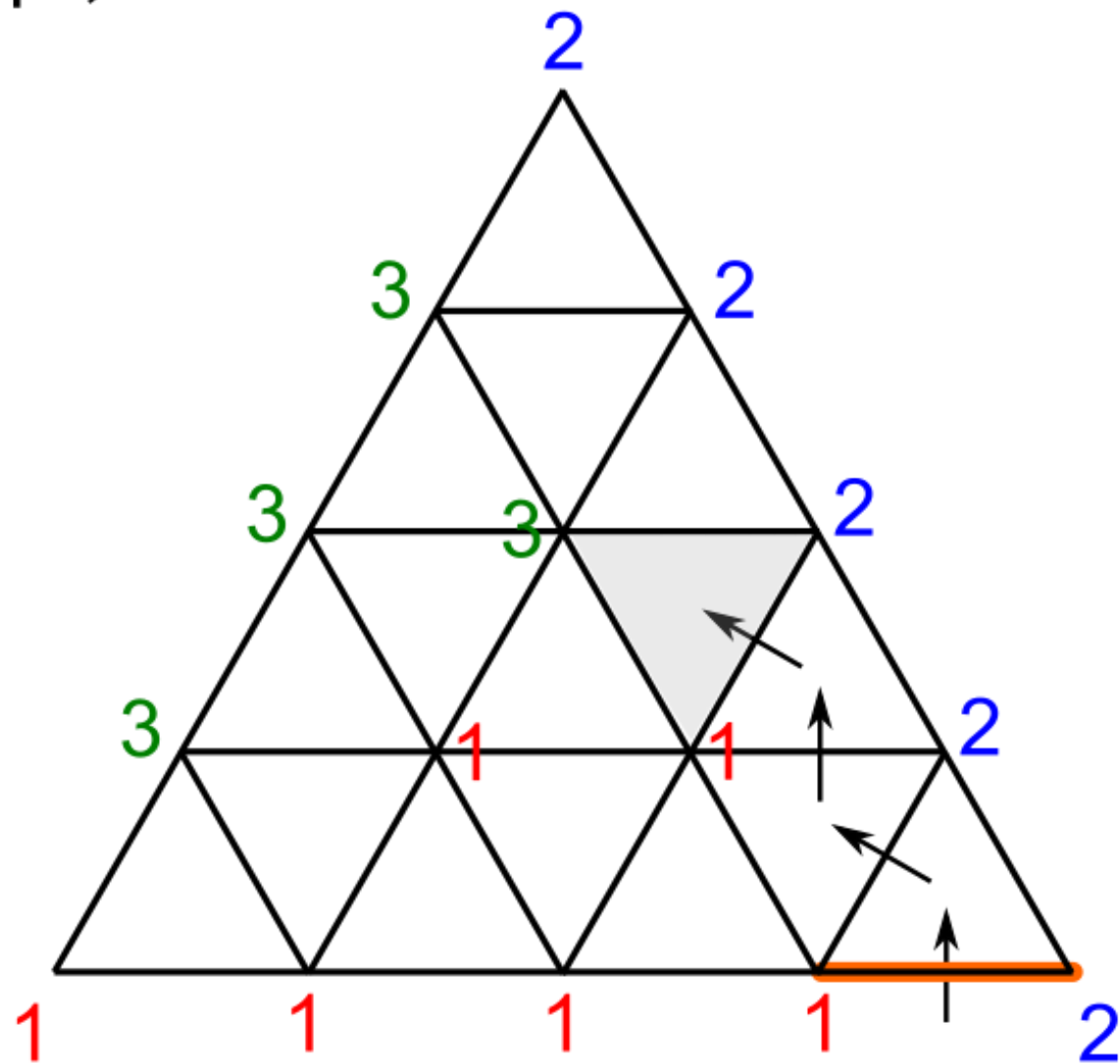

Fully labeled room \Rightarrow

a set of three "nearby"
pricing schemes at which
different agents prefer
different rooms

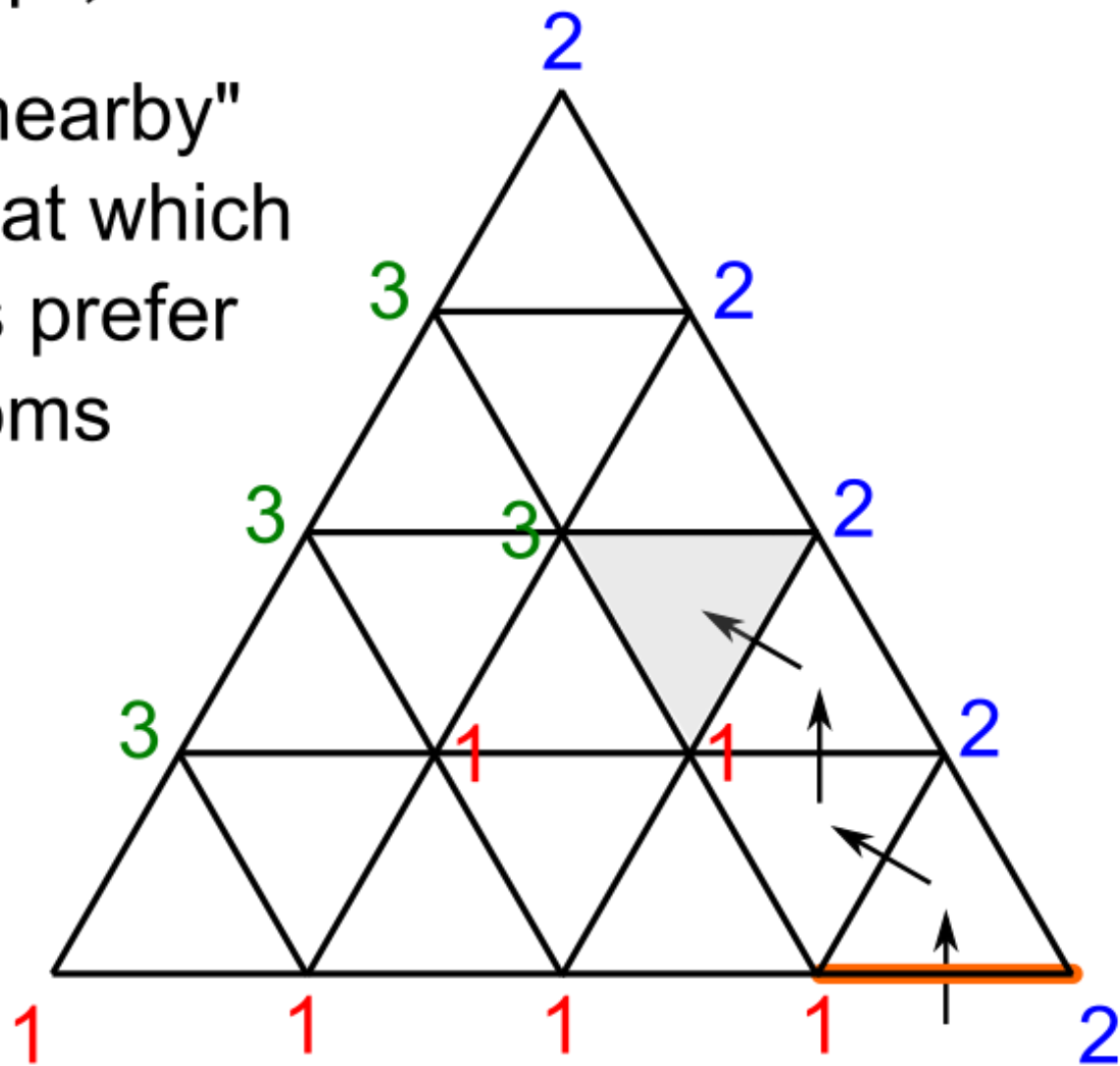

Fully labeled room \Rightarrow

a set of three "nearby"
pricing schemes at which
different agents prefer
different rooms

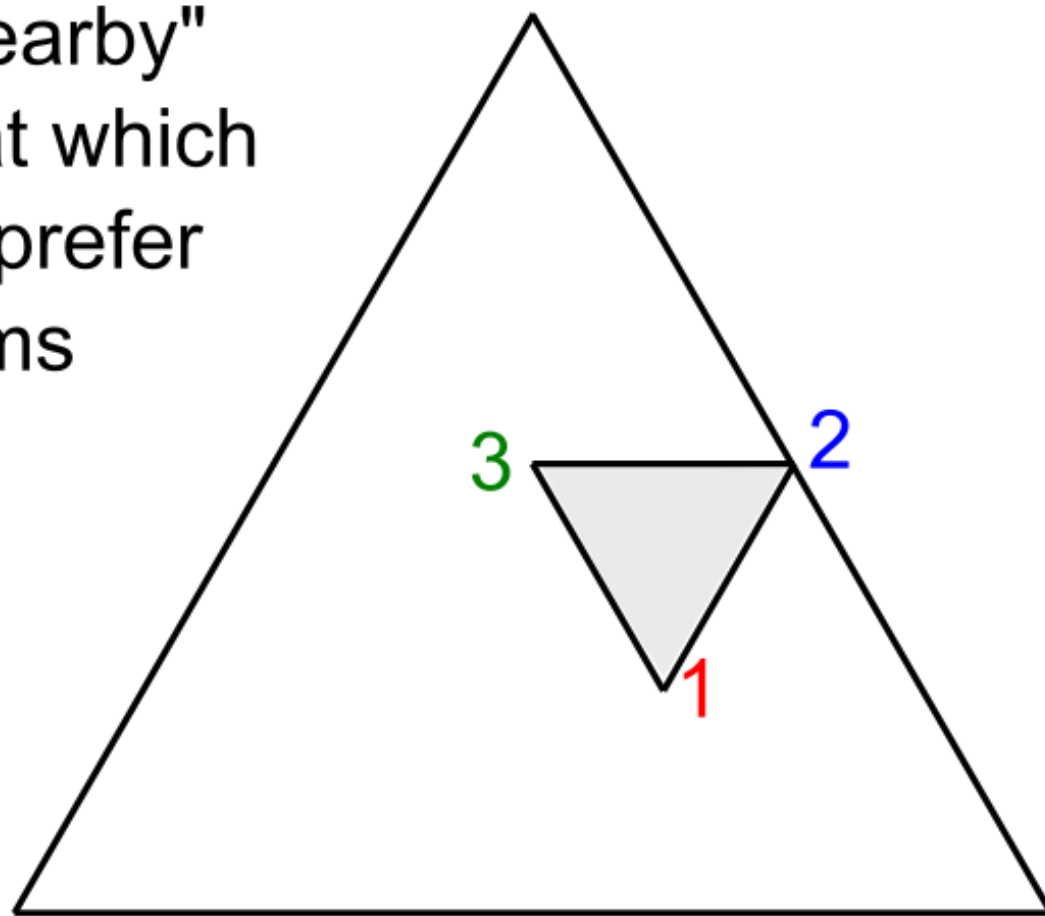

Fully labeled room \Rightarrow

a set of three "nearby"
pricing schemes at which
different agents prefer
different rooms

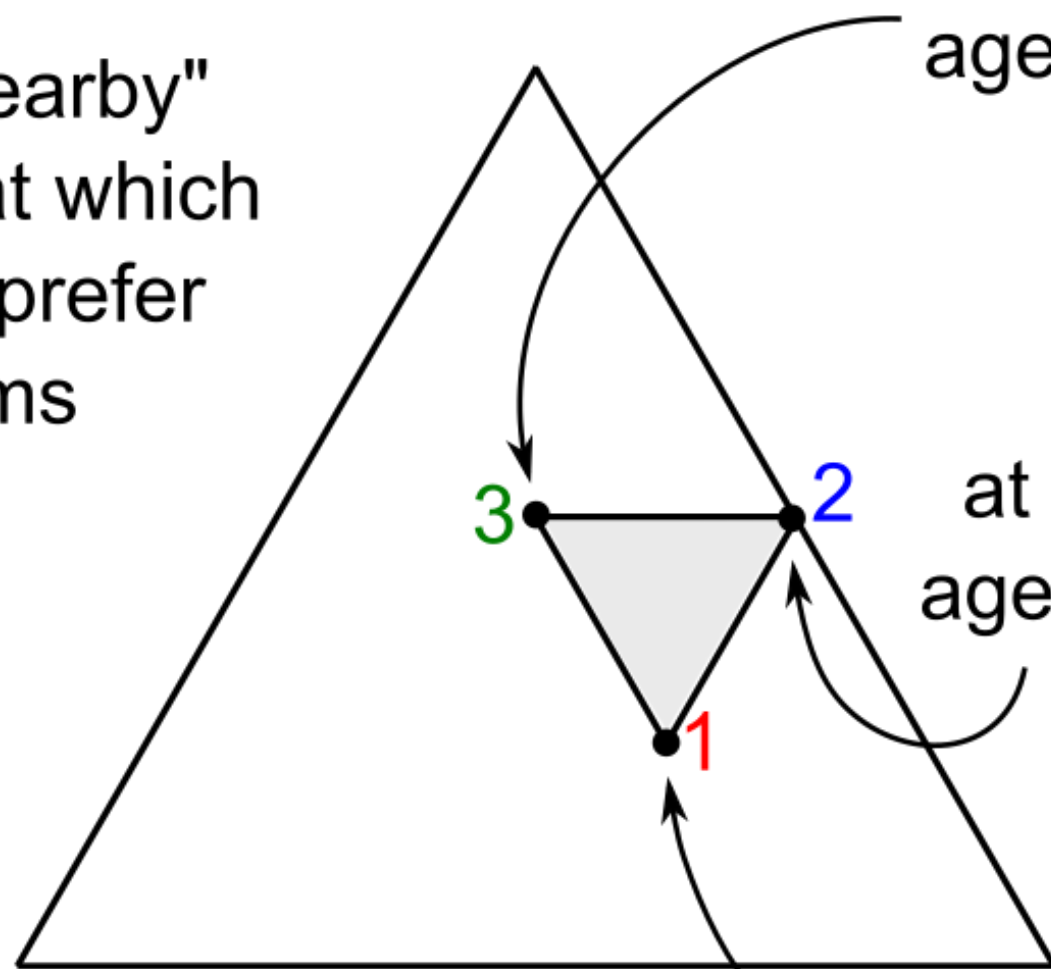

at prices (500, 250, 250)
agent A prefers room 3

at prices (500, 0, 500)
agent B prefers room 2

at prices (250, 250, 500)
agent C prefers room 1

Fully labeled room \Rightarrow

a set of three "nearby"
pricing schemes at which
different agents prefer
different rooms

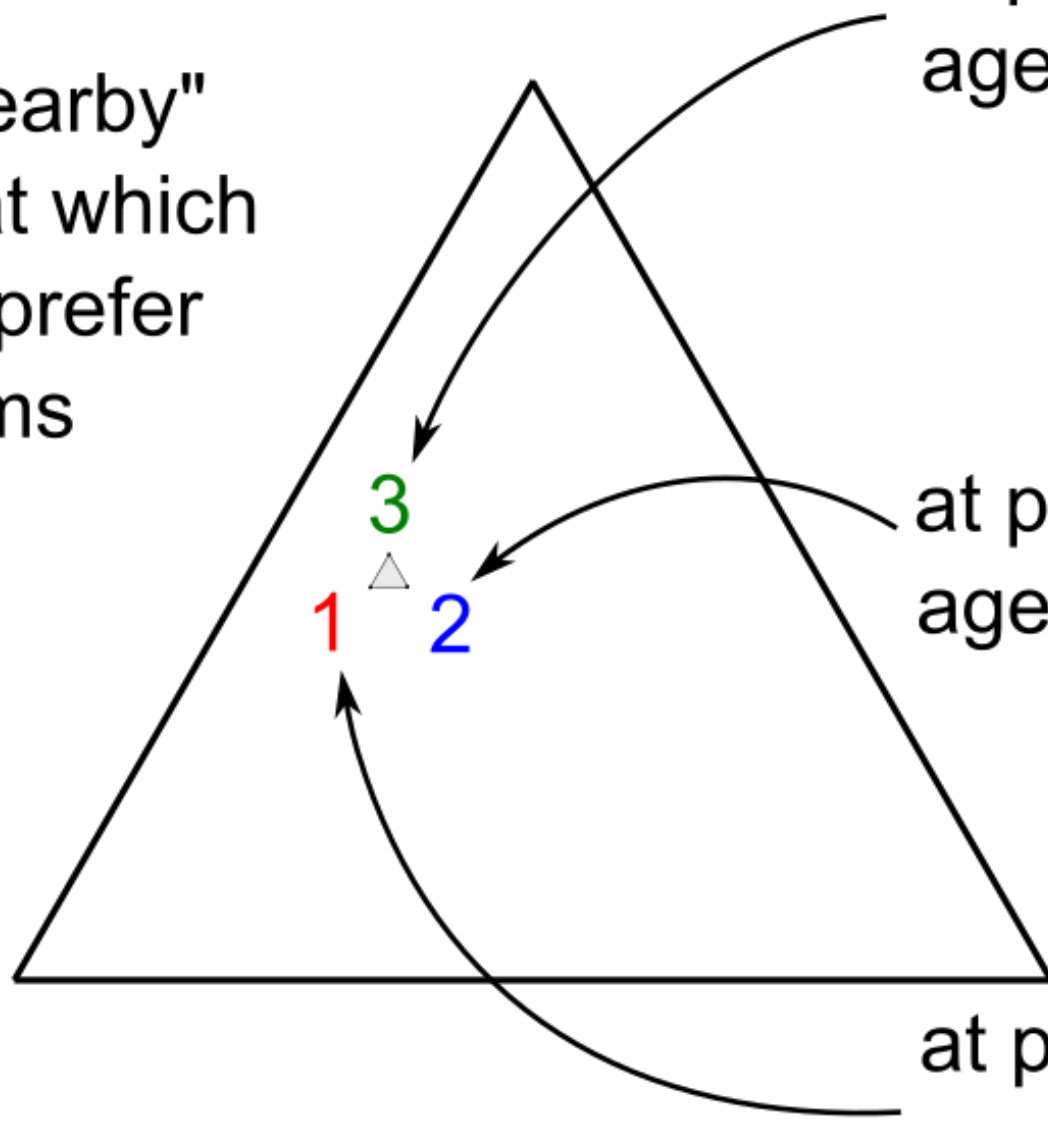

at prices (426, 424, 150)
agent A prefers room 3

at prices (425, 424, 151)
agent B prefers room 2

at prices (425, 425, 150)
agent C prefers room 1

Approx. envy-free rent division
(up to a rupee)

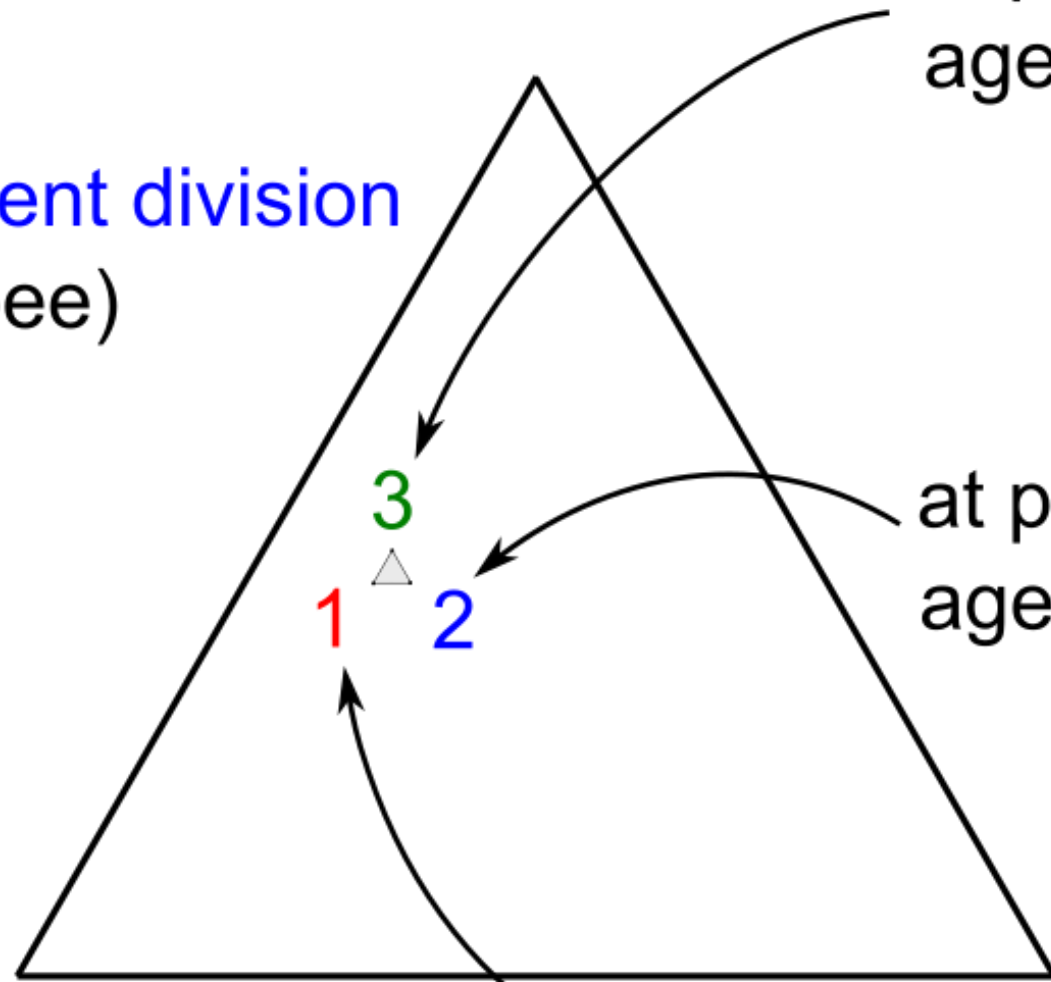

at prices (426, 424, 150)
agent A prefers room 3

at prices (425, 424, 151)
agent B prefers room 2

at prices (425, 425, 150)
agent C prefers room 1

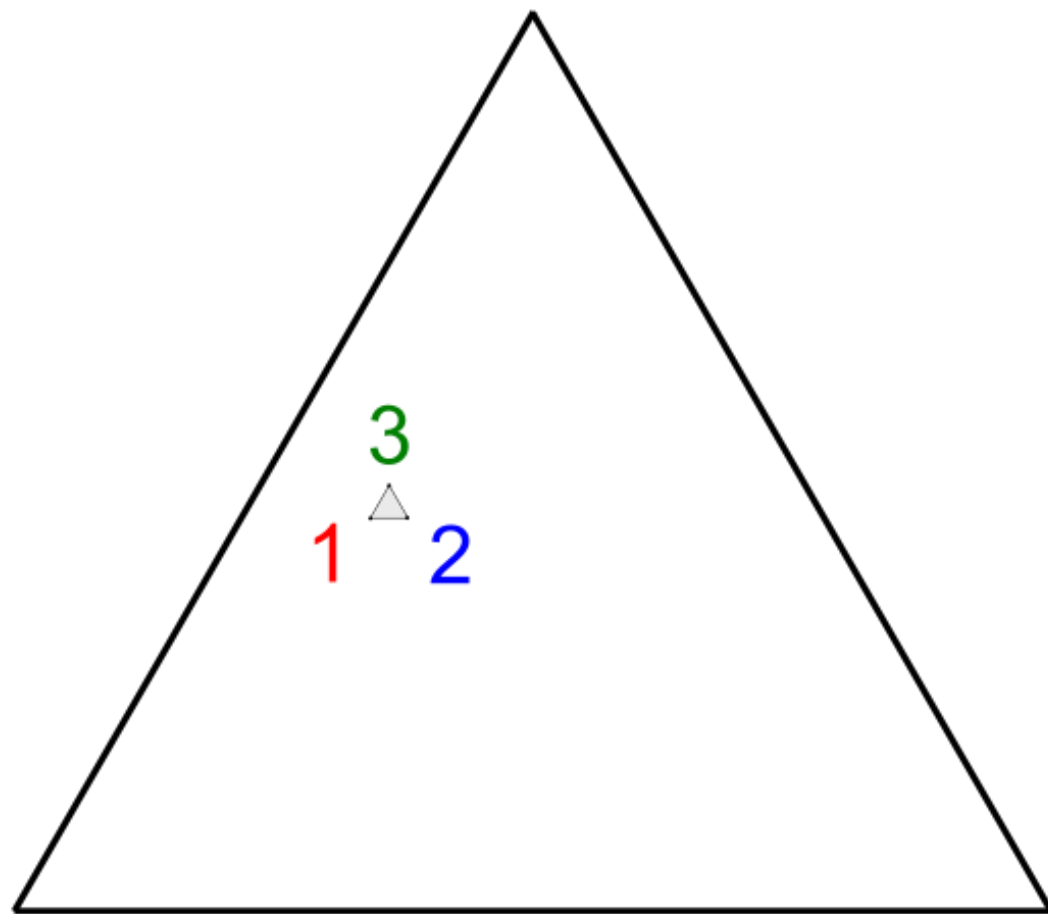

[Su, *Amer. Math. Mon.* 1999]

For *closed* preferences, an *exact* envy-free rent division exists.

"closed preferences"

a room preferred for a convergent
sequence of pricing schemes
is also preferred in the limit

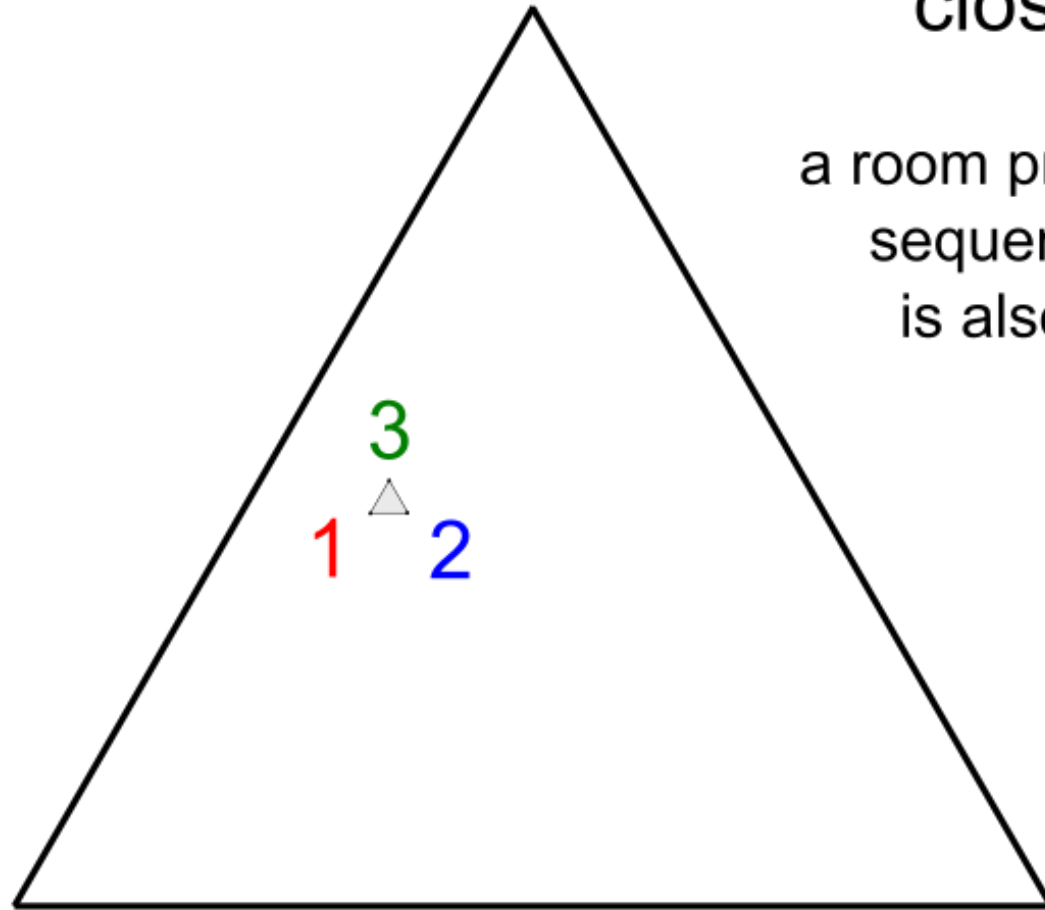

[Su, *Amer. Math. Mon.* 1999]

For *closed* preferences, an *exact* envy-free rent division exists.

"closed preferences"

a room preferred for a convergent
sequence of pricing schemes
is also preferred in the limit

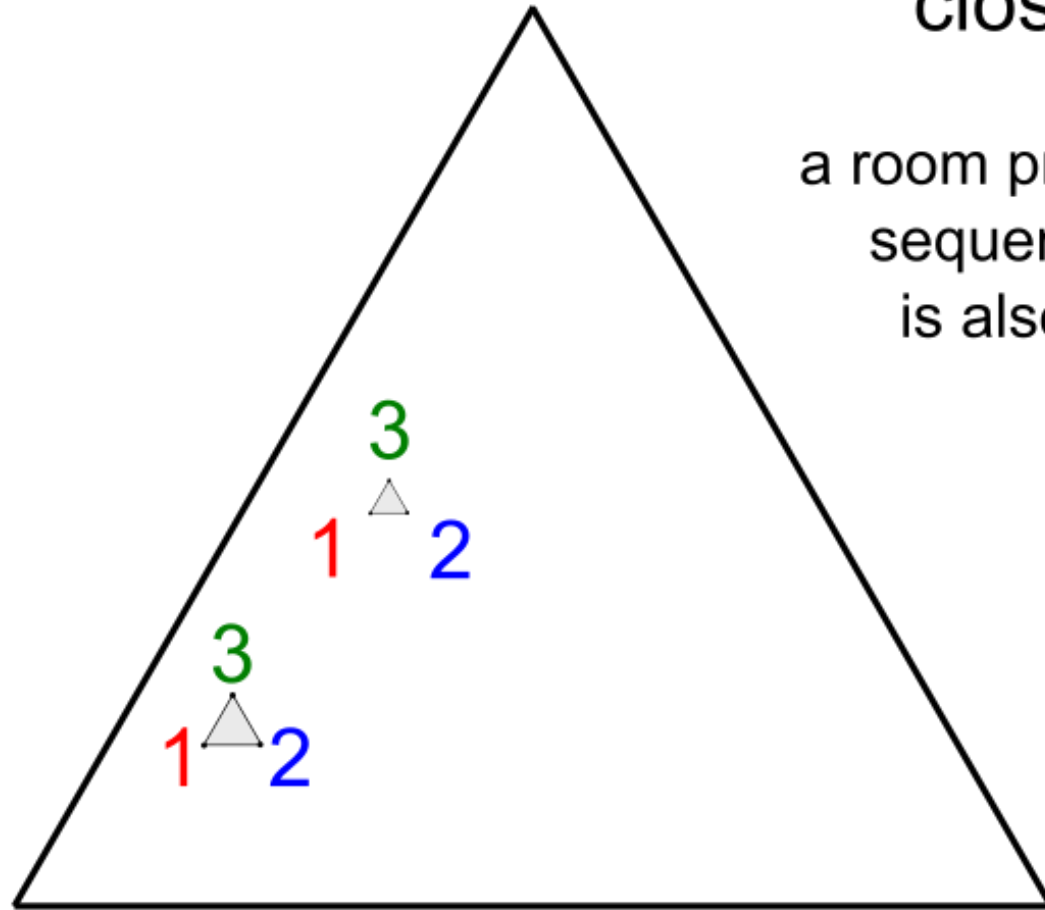

[Su, *Amer. Math. Mon.* 1999]

For *closed* preferences, an *exact* envy-free rent division exists.

"closed preferences"

a room preferred for a convergent
sequence of pricing schemes
is also preferred in the limit

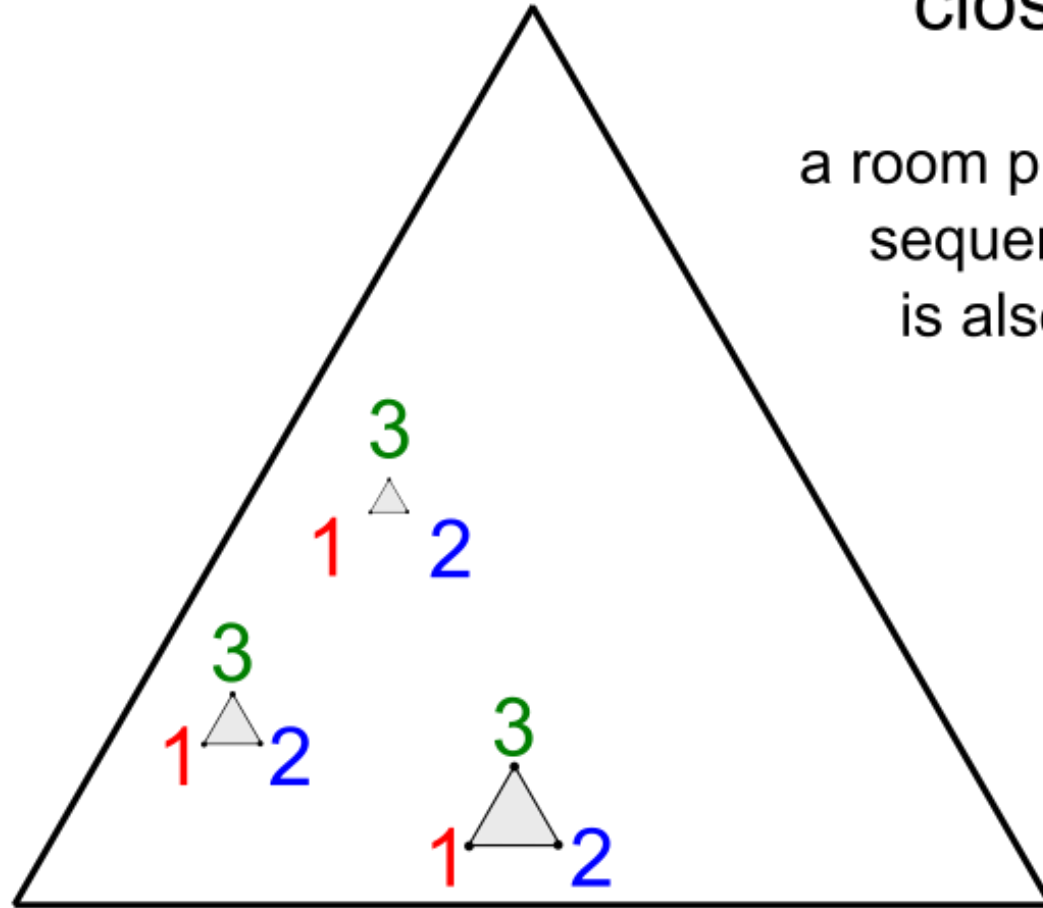

[Su, *Amer. Math. Mon.* 1999]

For *closed* preferences, an *exact* envy-free rent division exists.

"closed preferences"

a room preferred for a convergent
sequence of pricing schemes
is also preferred in the limit

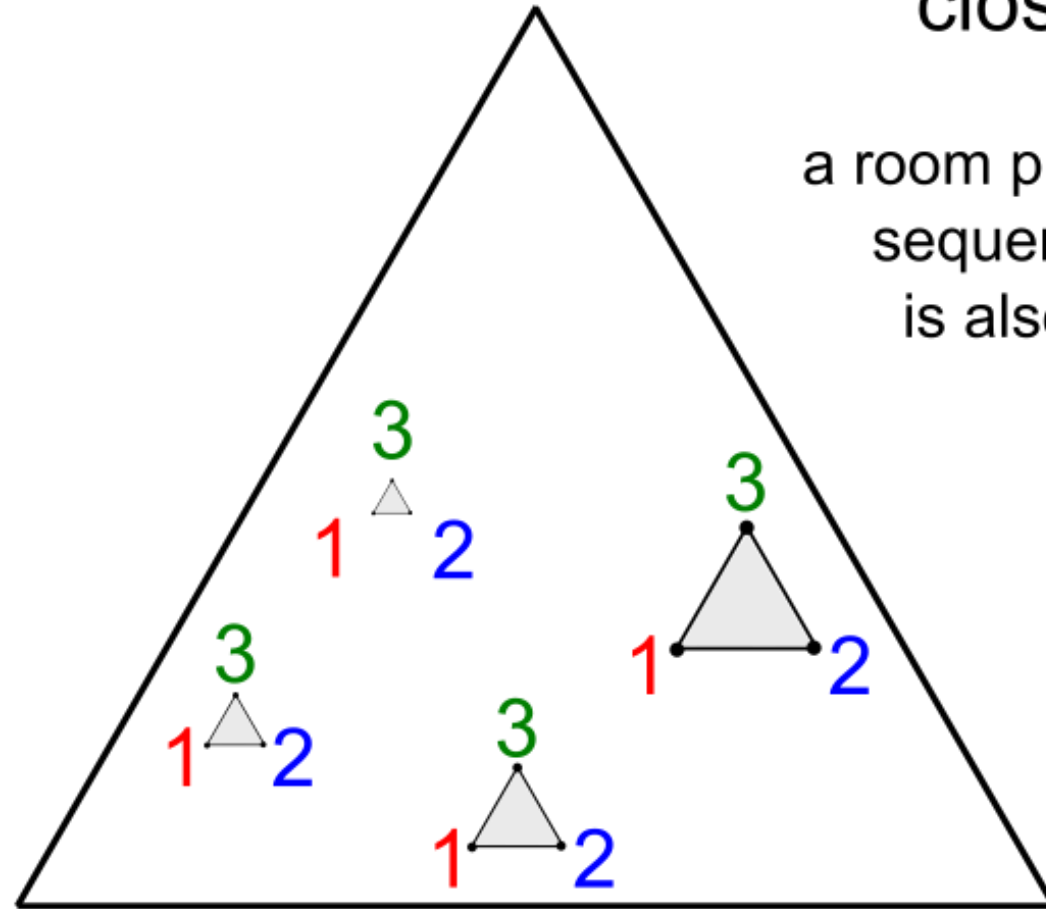

[Su, *Amer. Math. Mon.* 1999]

For *closed* preferences, an *exact* envy-free rent division exists.

Approach 1
Case analysis

Approach 2
Thinking outside the box

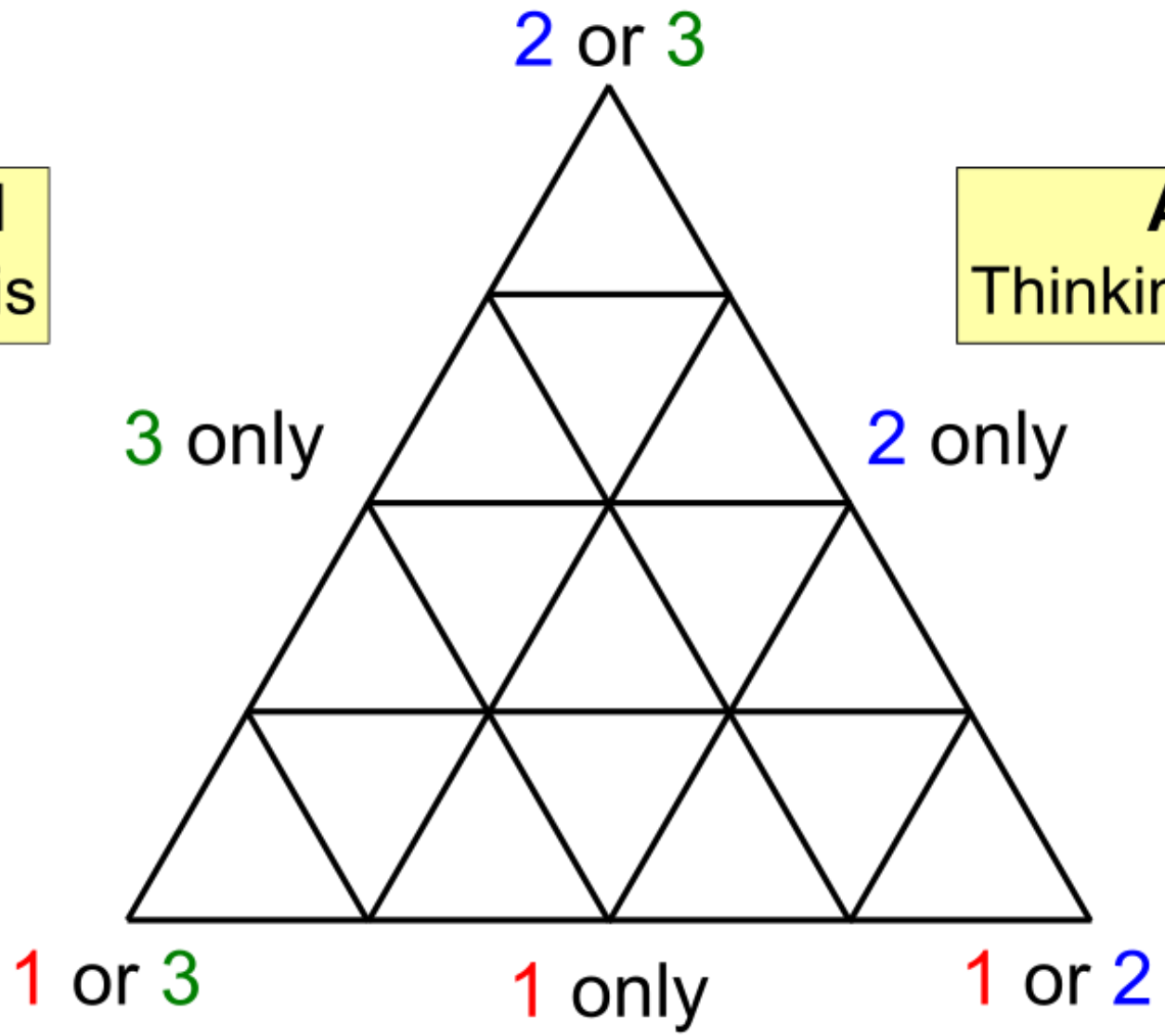

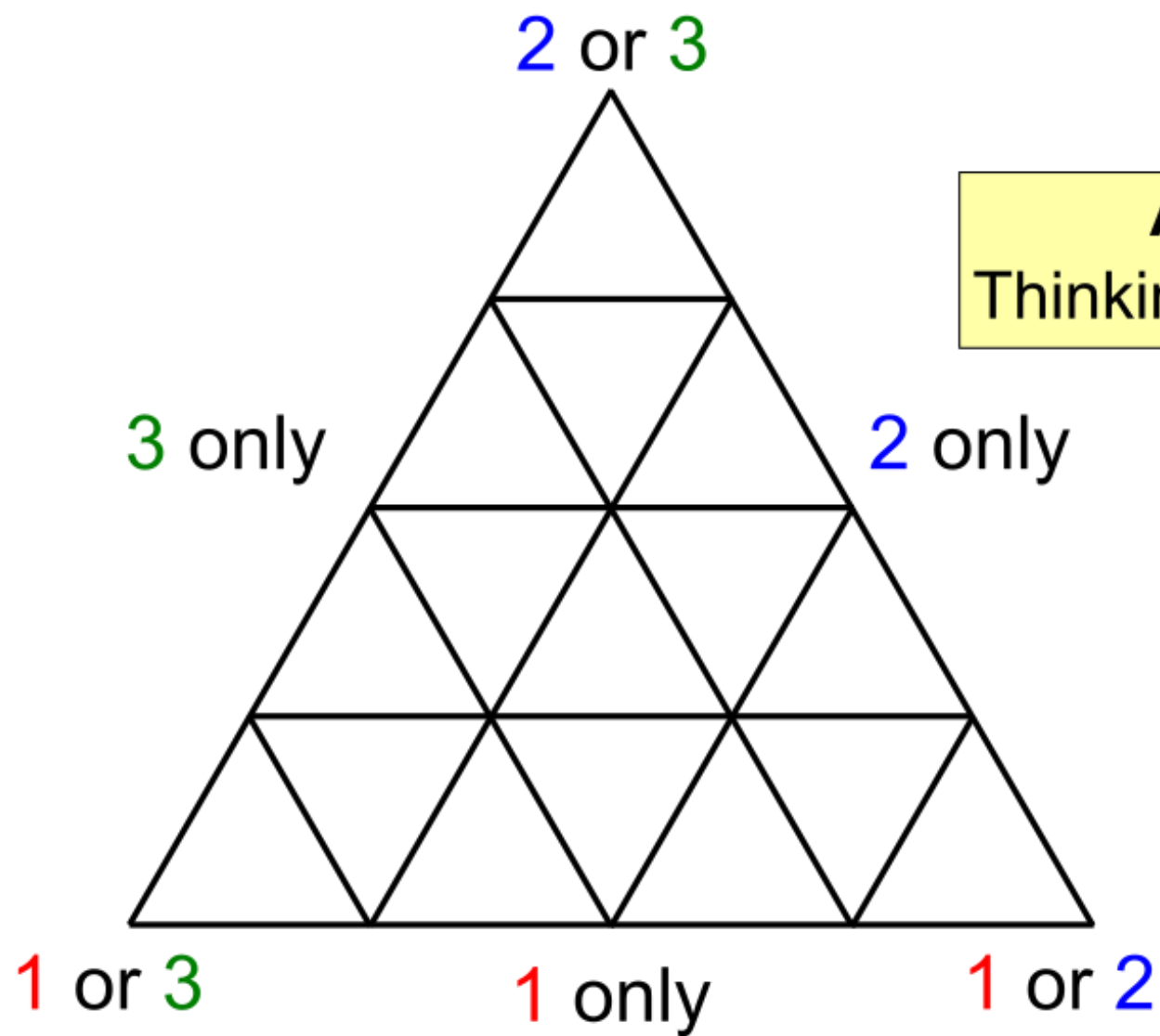

Approach 2
Thinking outside the box

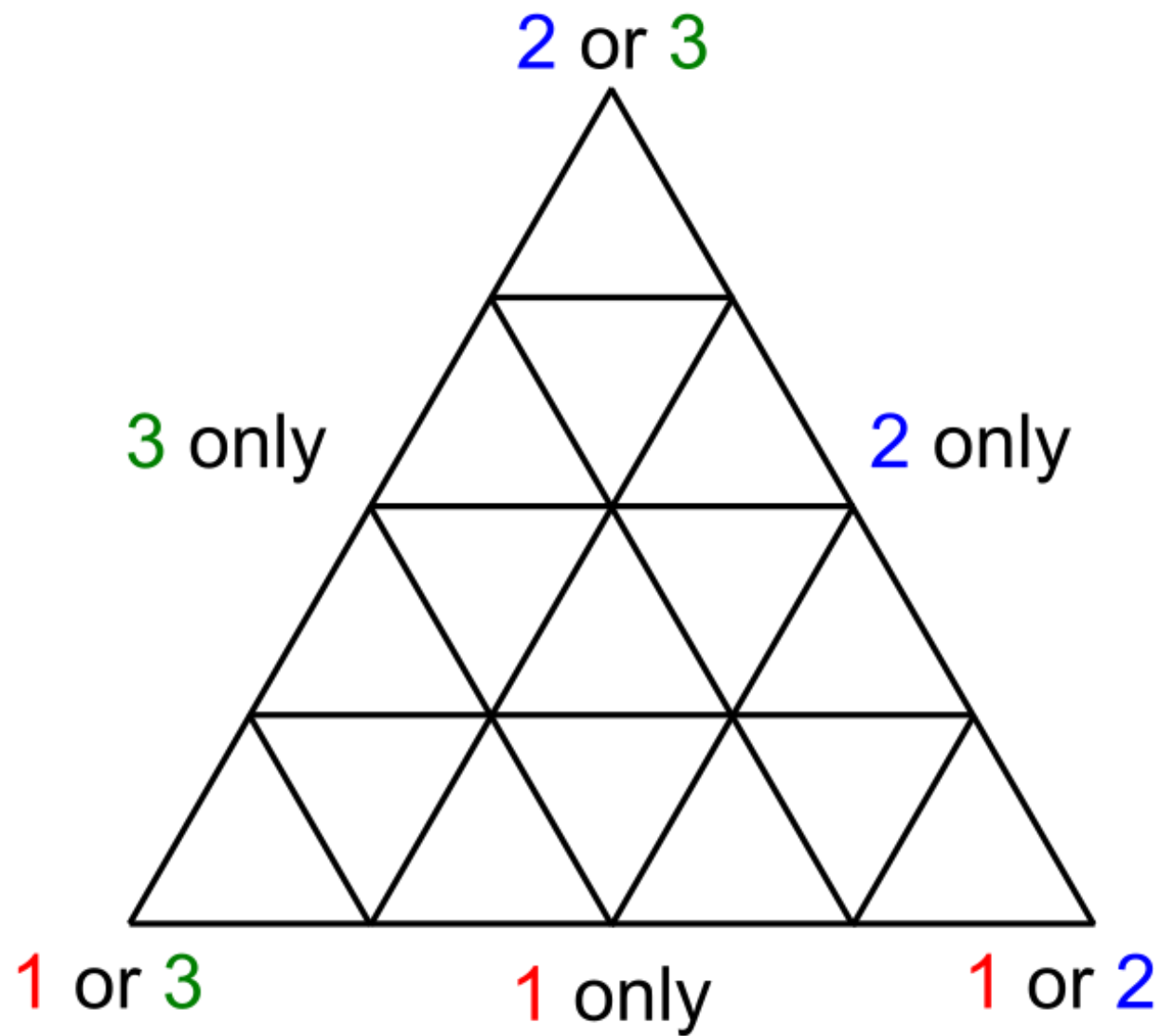

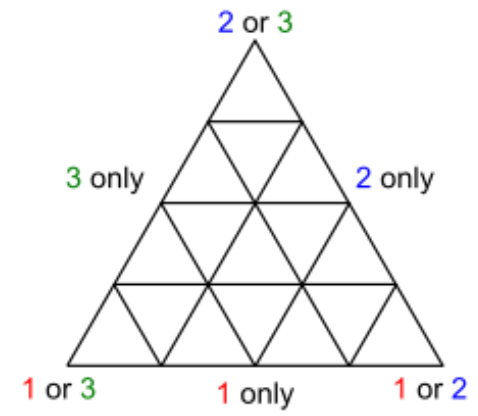

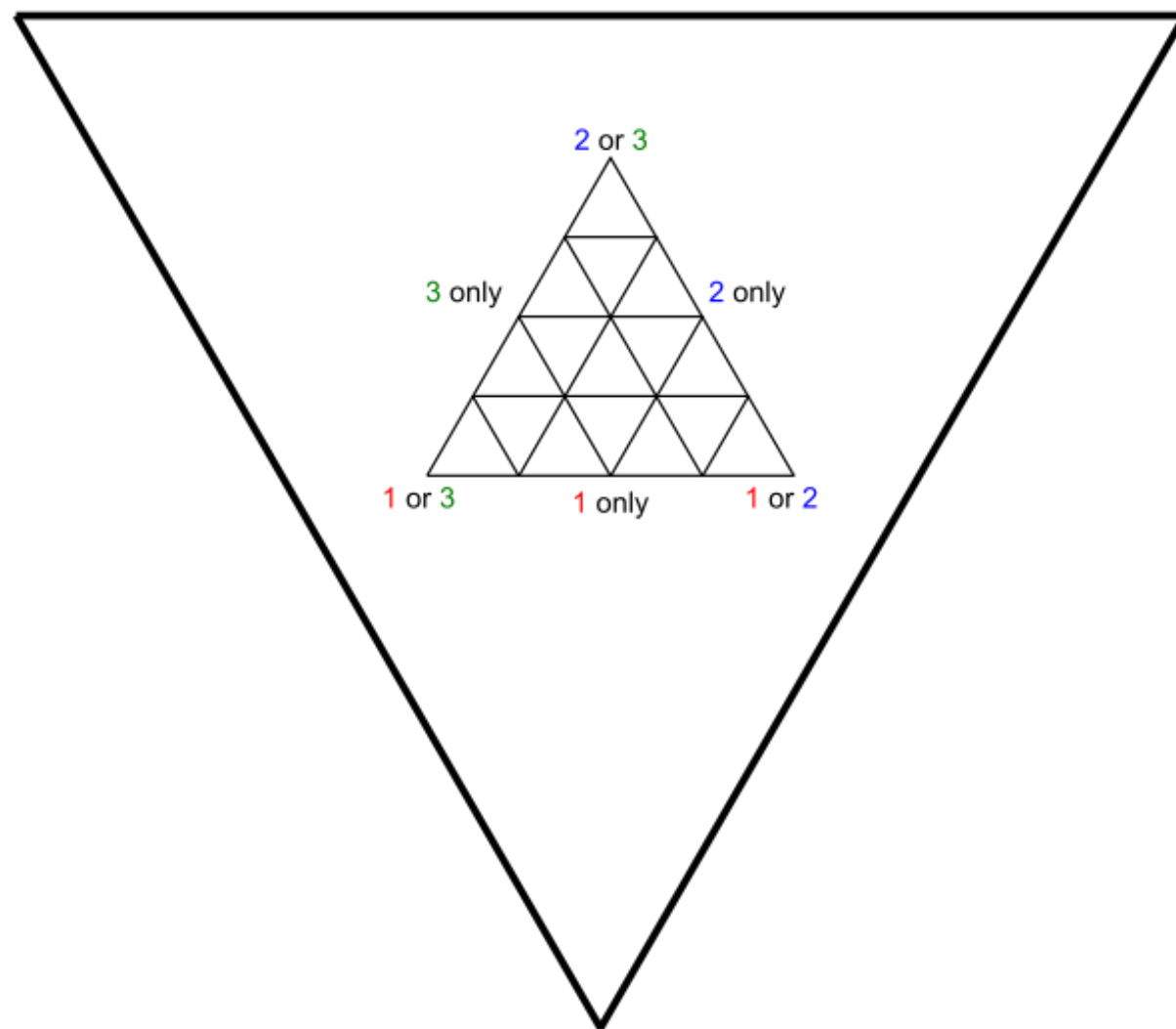

3

2

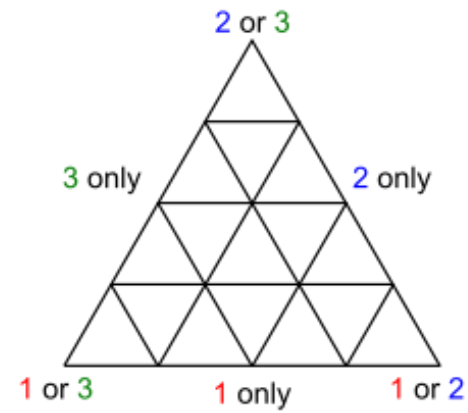

1

3

2

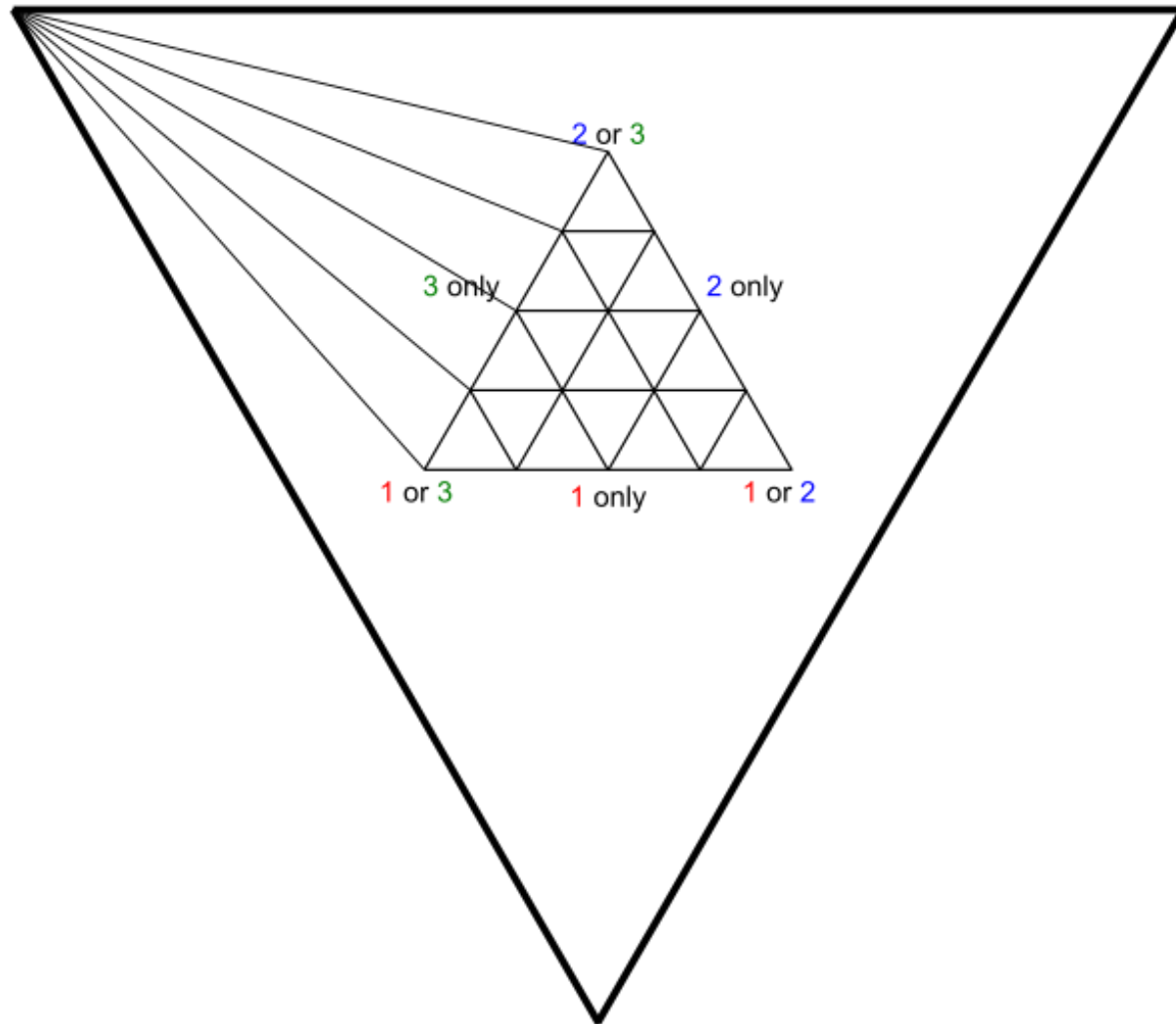

1

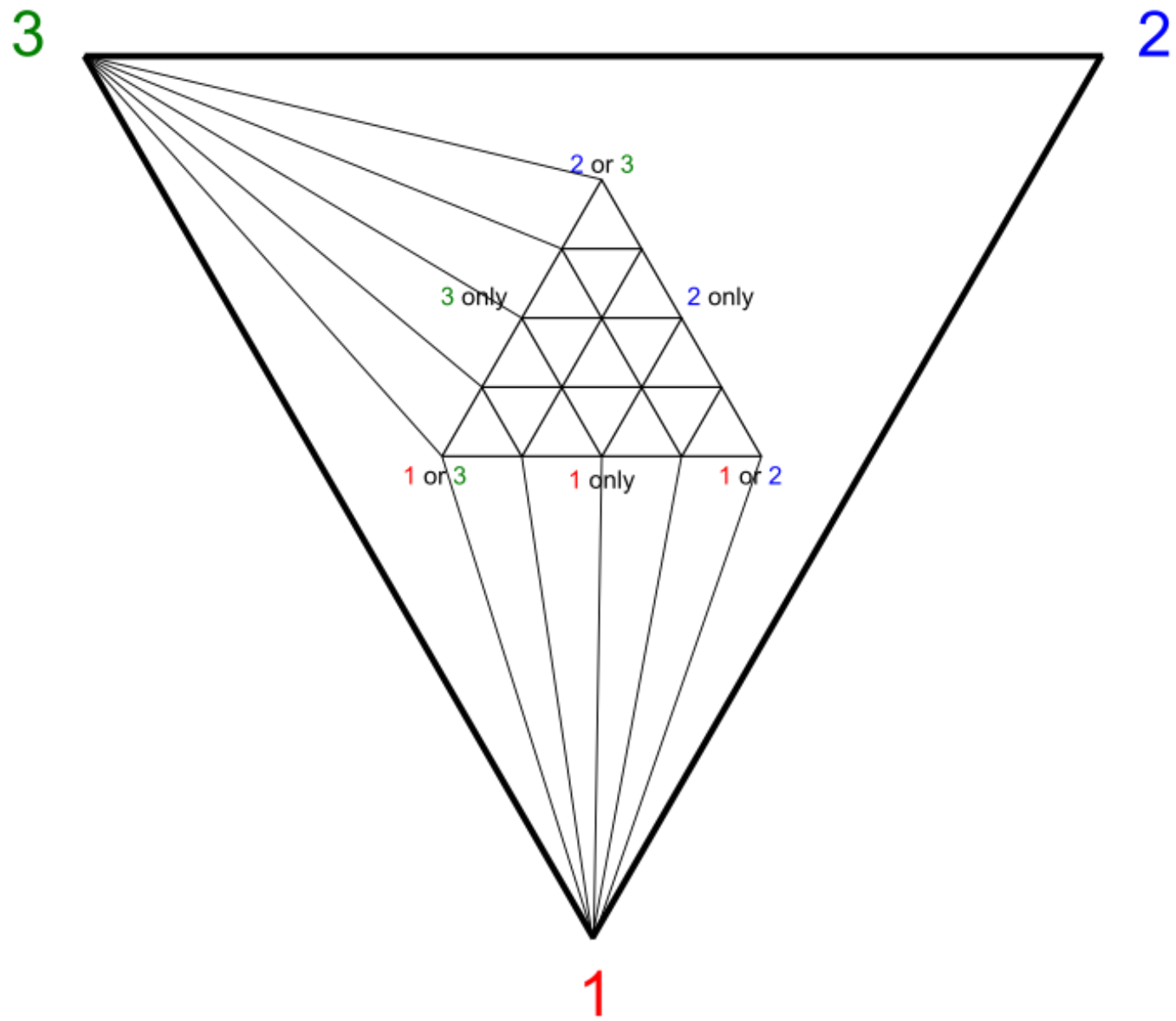

3

2

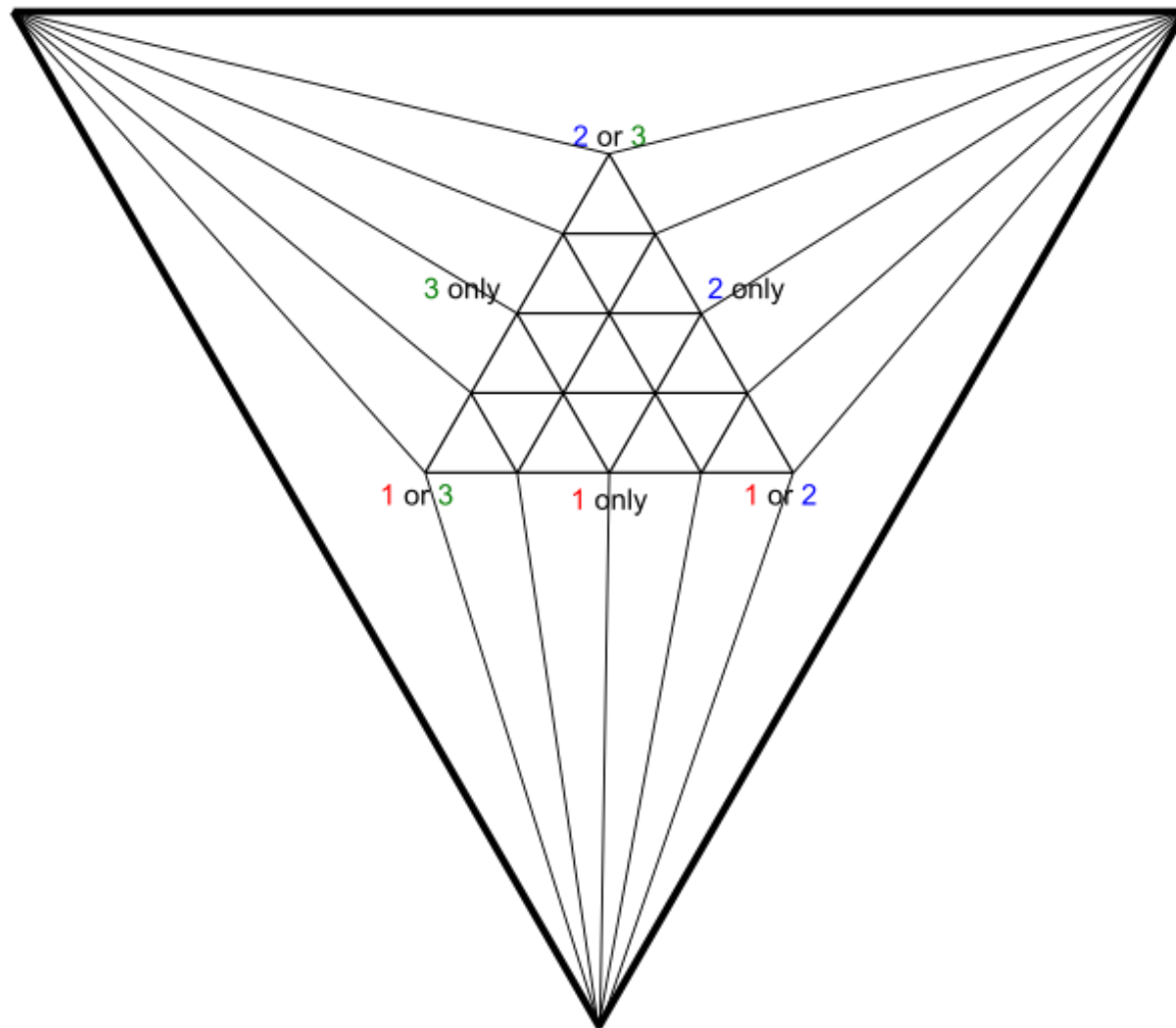

1

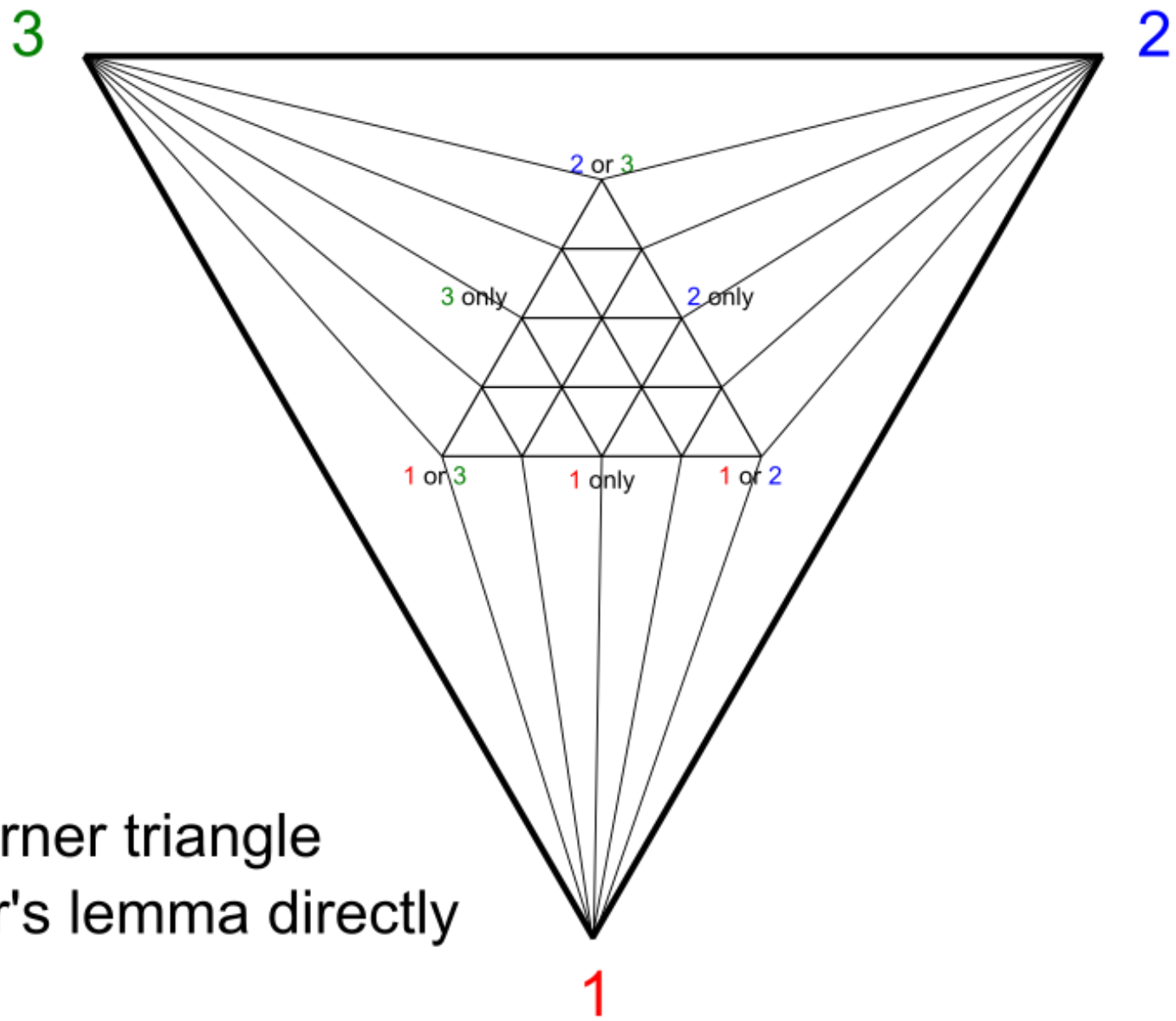

A valid Sperner triangle
⇒ apply Sperner's lemma directly

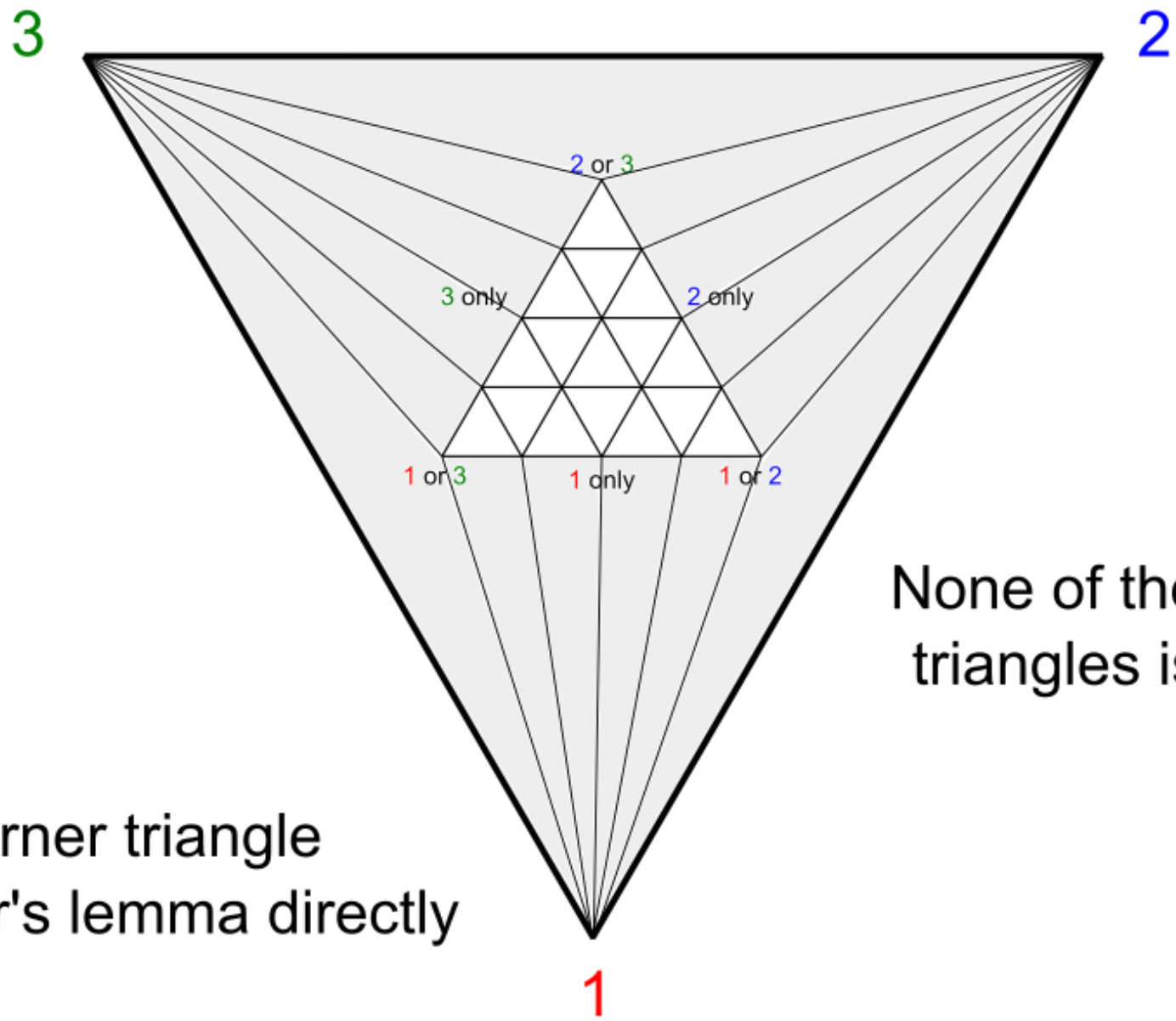

None of the newly added triangles is fully labeled

A valid Sperner triangle
⇒ apply Sperner's lemma directly

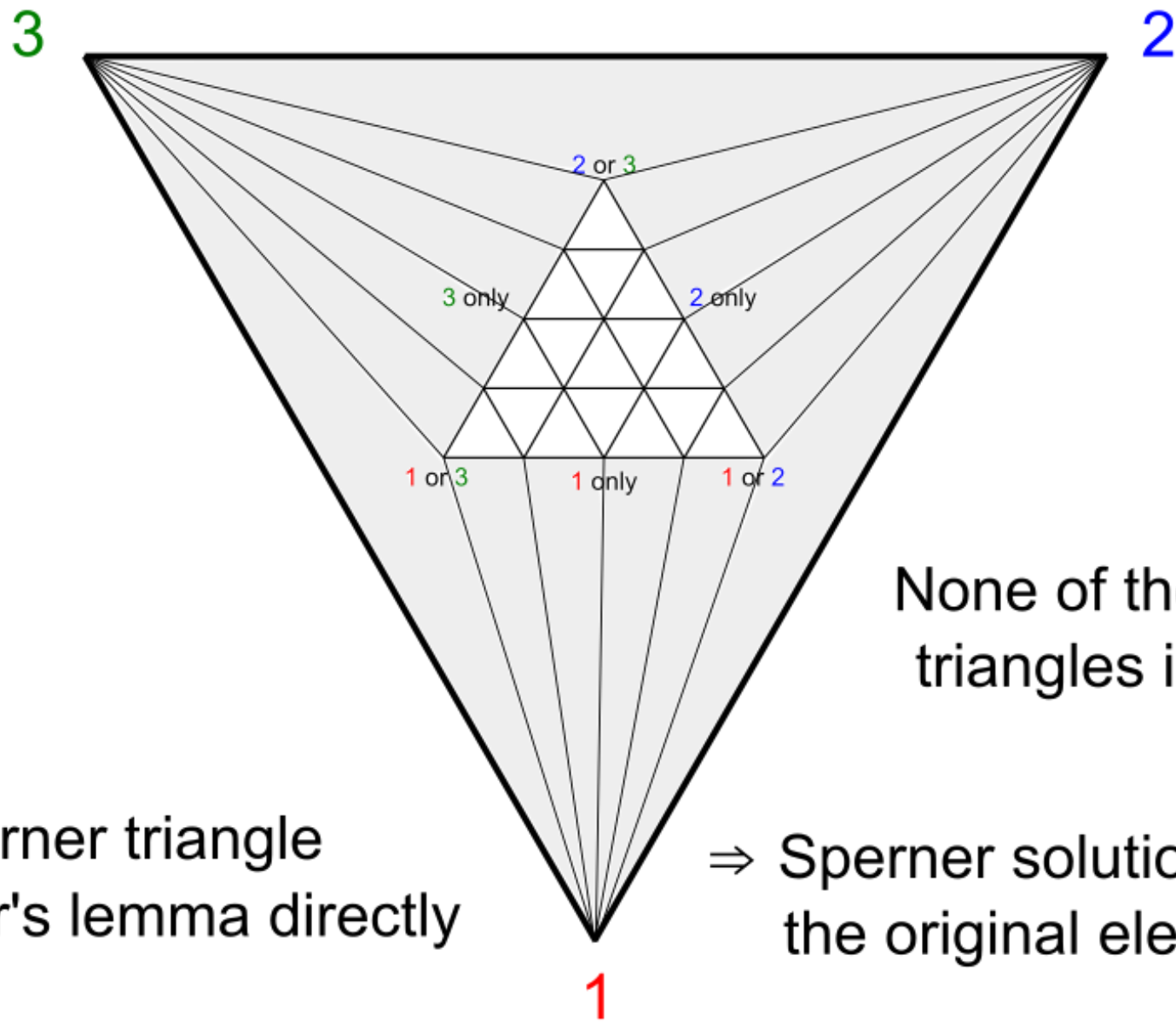

None of the newly added triangles is fully labeled

A valid Sperner triangle
 ⇒ apply Sperner's lemma directly

⇒ Sperner solution must be one of the original elementary triangles

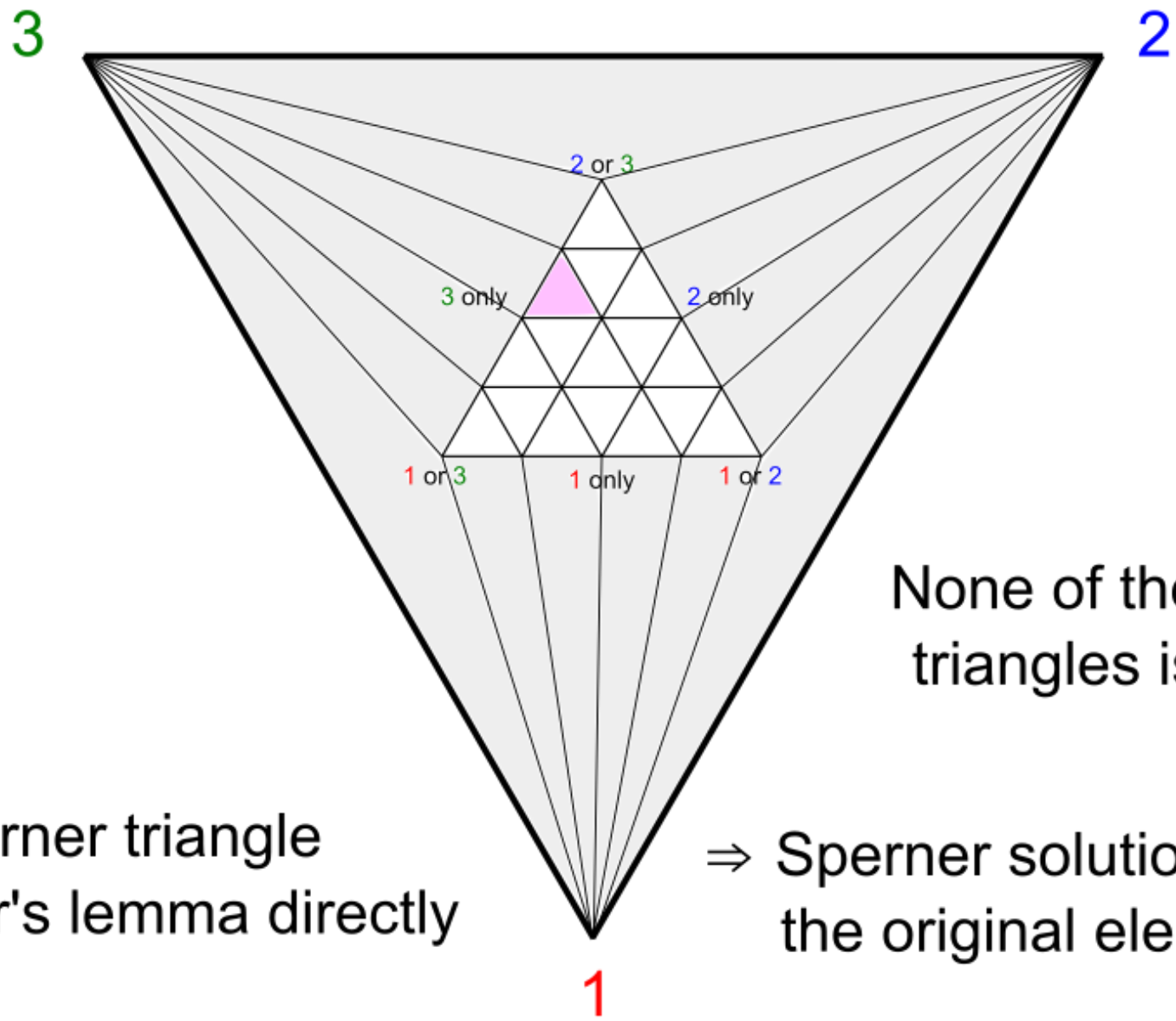

None of the newly added triangles is fully labeled

A valid Sperner triangle
 ⇒ apply Sperner's lemma directly

⇒ Sperner solution must be one of the original elementary triangles

1

Recap

Recap

Ownership labeling

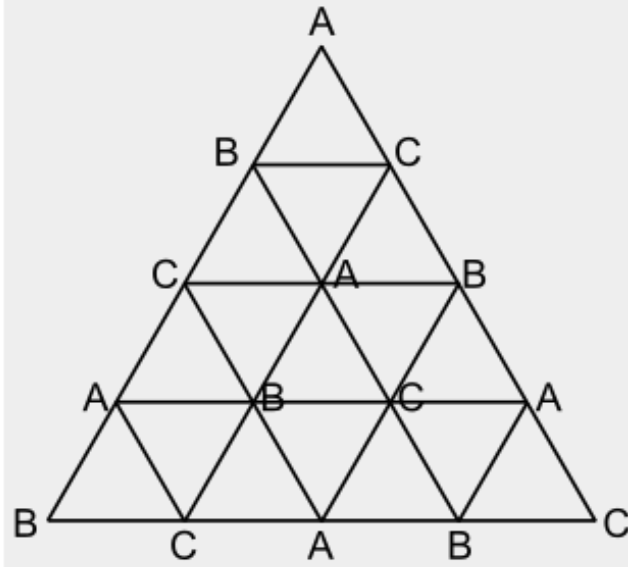

Preference labeling

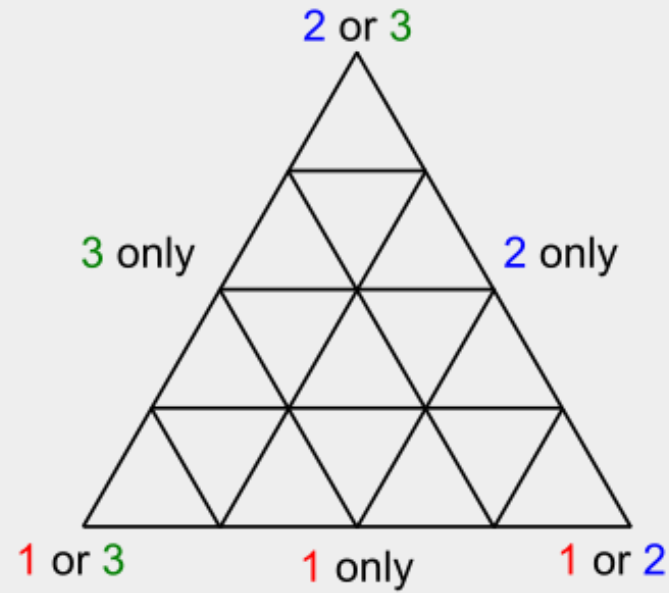

Recap

Ownership labeling

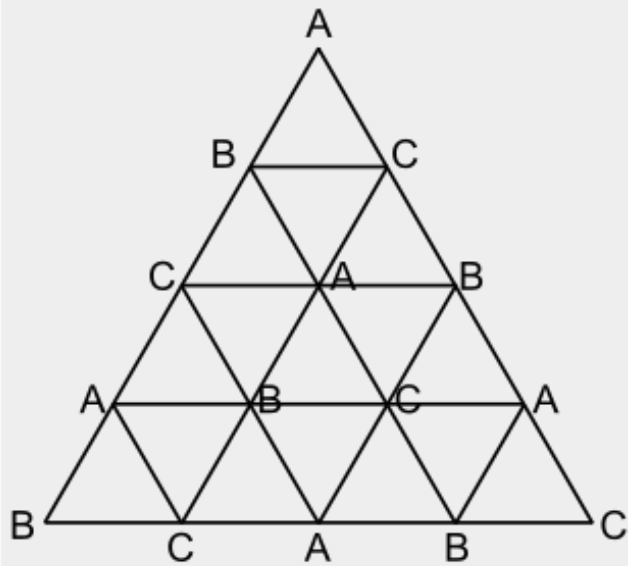

Preference labeling

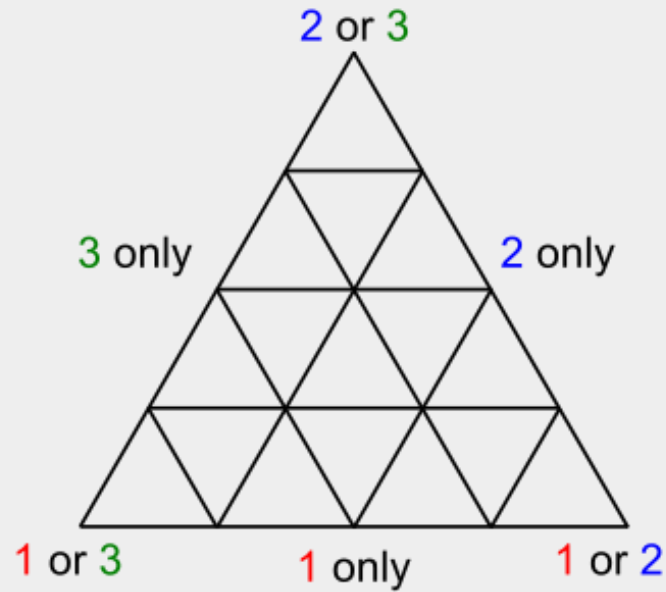

Case analysis

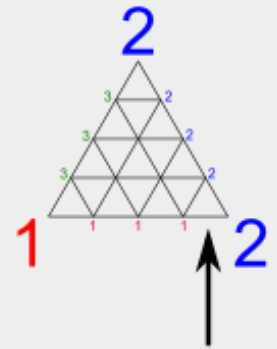

Sperner doesn't apply, but "proof by walking" does

OR

Embedding

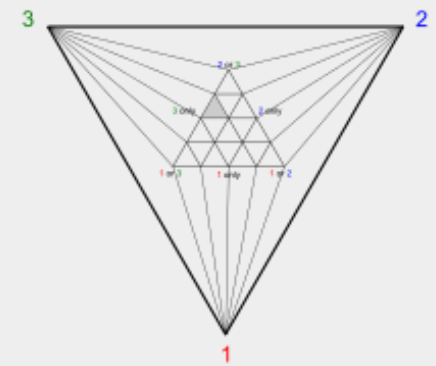

Sperner directly applies

Recap

Ownership labeling

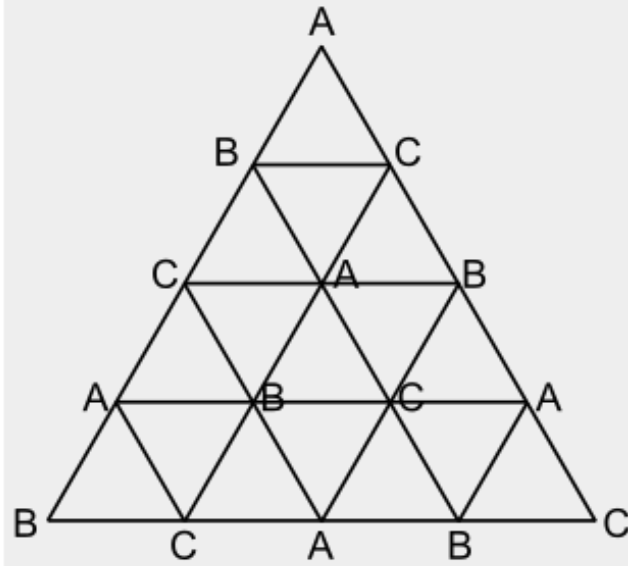

Preference labeling

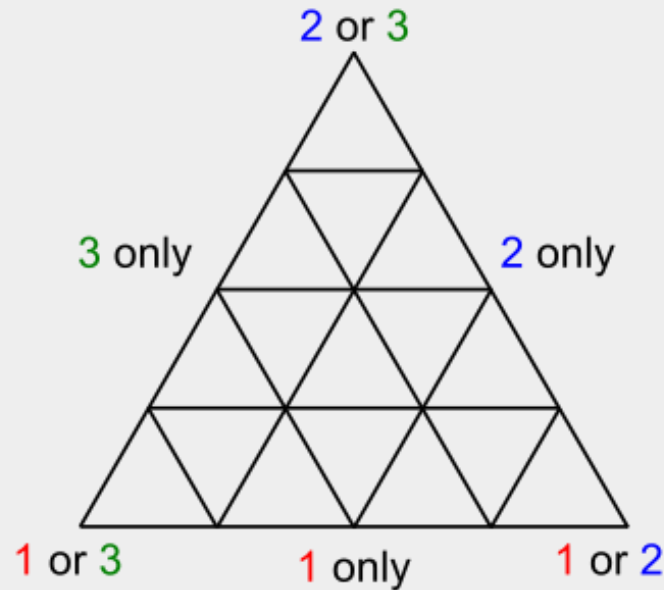

Case analysis

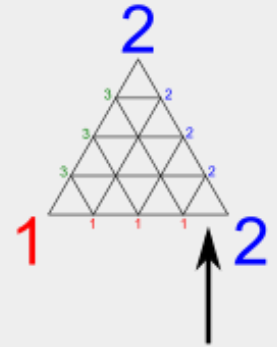

Sperner doesn't apply, but "proof by walking" does

OR

Embedding

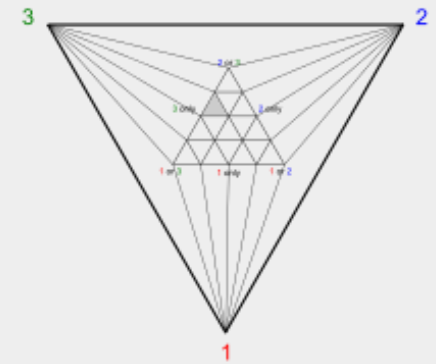

Sperner directly applies

Approximate envy-freeness

(for a sufficiently fine triangulation)

Exact envy-freeness

(for closed preferences)

Other Applications of Sperner's Lemma

Envy-free cake cutting with connected pieces



Monsky's theorem

A square cannot be dissected into an odd number of triangles with equal area.

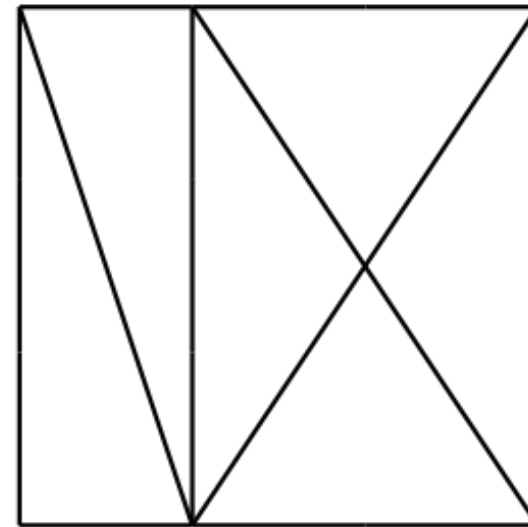
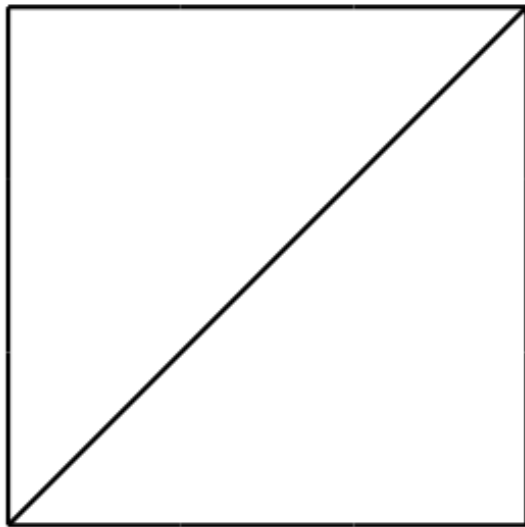

Brouwer's fixed point theorem

Every continuous function from a compact convex set to itself has a fixed point.

Brouwer's fixed point theorem

$$f(x) = x$$

Every continuous function from a compact convex set to itself has a fixed point.

Brouwer's fixed point theorem

$$\curvearrowright f(x) = x$$

Every continuous function from a compact convex set to itself has a fixed point.



Brouwer's fixed point theorem

$$\curvearrowright f(x) = x$$

Every continuous function from a compact convex set to itself has a fixed point.



Brouwer's fixed point theorem

$$\curvearrowright f(x) = x$$

Every continuous function from a compact convex set to itself has a fixed point.



Brouwer's fixed point theorem

$$f(x) = x$$

Every continuous function from a compact convex set to itself has a fixed point.



- Used to prove the existence of Nash equilibrium in game theory

Next Time

Fair Division of Indivisible Items



References

- Fair cake cutting and rent division via Sperner's Lemma

Francis Su

"Rental Harmony: Sperner's Lemma in Fair Division"

American Mathematical Monthly, 106, 1999 pg 930-942

- Fun videos on the topic:

Mathologer: <https://www.youtube.com/watch?v=7s-YM-kcKME>

MoMath: <https://www.youtube.com/watch?v=CBVg8x4LWZE>

PBS Infinite Series: <https://www.youtube.com/watch?v=48oBEvpdYSE>

